

Technische Daten: Art.-Nr.: 231160

Wandaußenmaß: 400 x 250 cm

Bohlenstärke: 40 mm



Kontrolliert durch:

Empty box for signature or name.

Achtung: Alle angegebenen Maße sind ca.-Maße!

3D-Darstellung u. Grundriss 231160

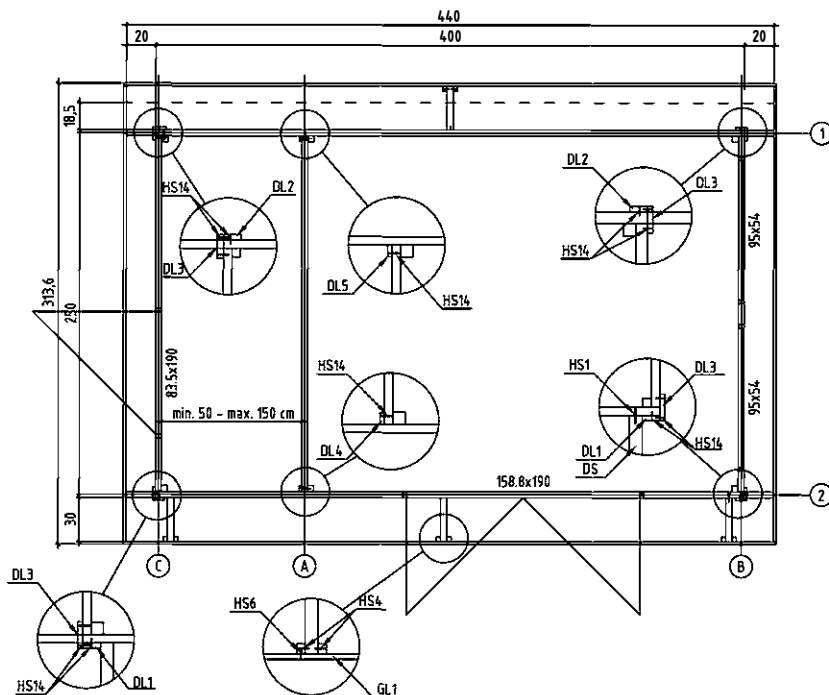
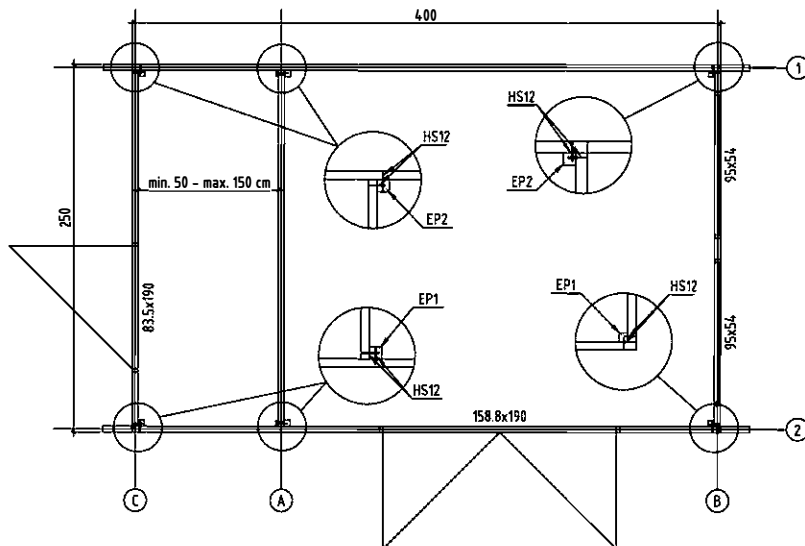

Lagerholzplan und Fundamentplan 231160

**Wir empfehlen als Fundament für Ihr Gartenhaus eine vollflächig festgegründete, gepflasterte oder betonierte Fläche.
Wahlweise ist auch ein Punkt- oder Streifenfundament möglich.**

Foundation - Fundament - Fondation - Fondamenta - Fundering -
Immutatud alusraam

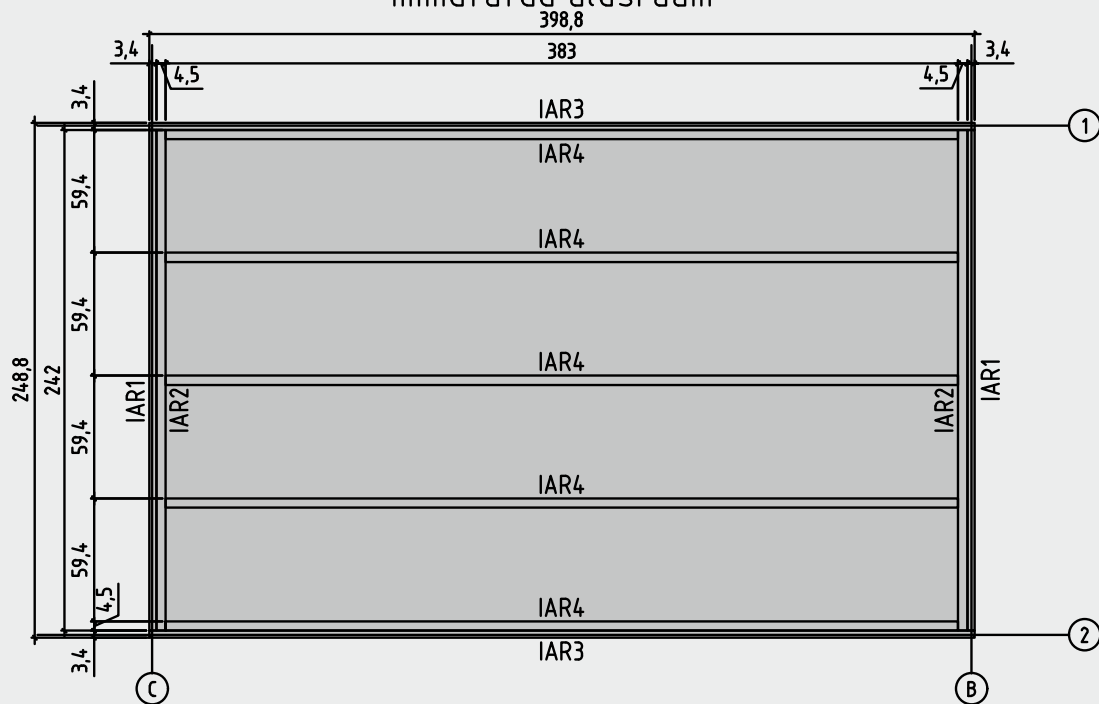

Fußboden- und Dachplan

231160

Floor boards - Fussbodenbretter - Plan pose plancher - Pavimento -
Vloerhout - Põrandalaudis

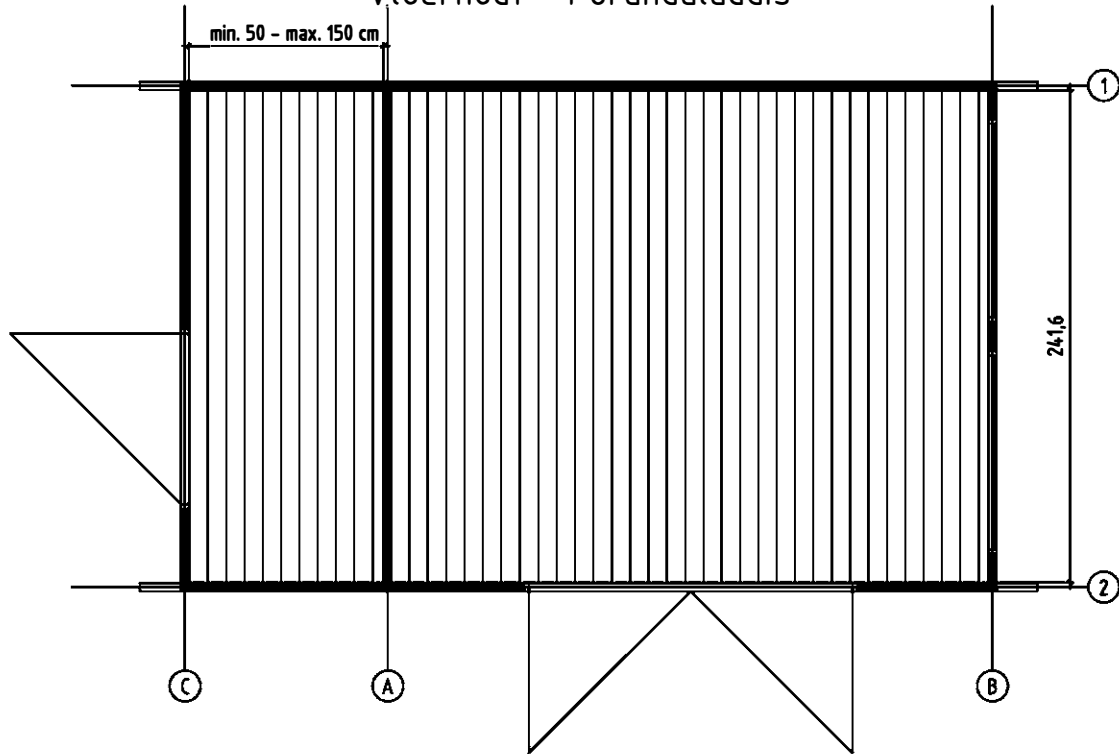

Roof plan - Dach-plan - Plan du toit - Piano del tetto - Dak
plattegrond - Katuseplaan

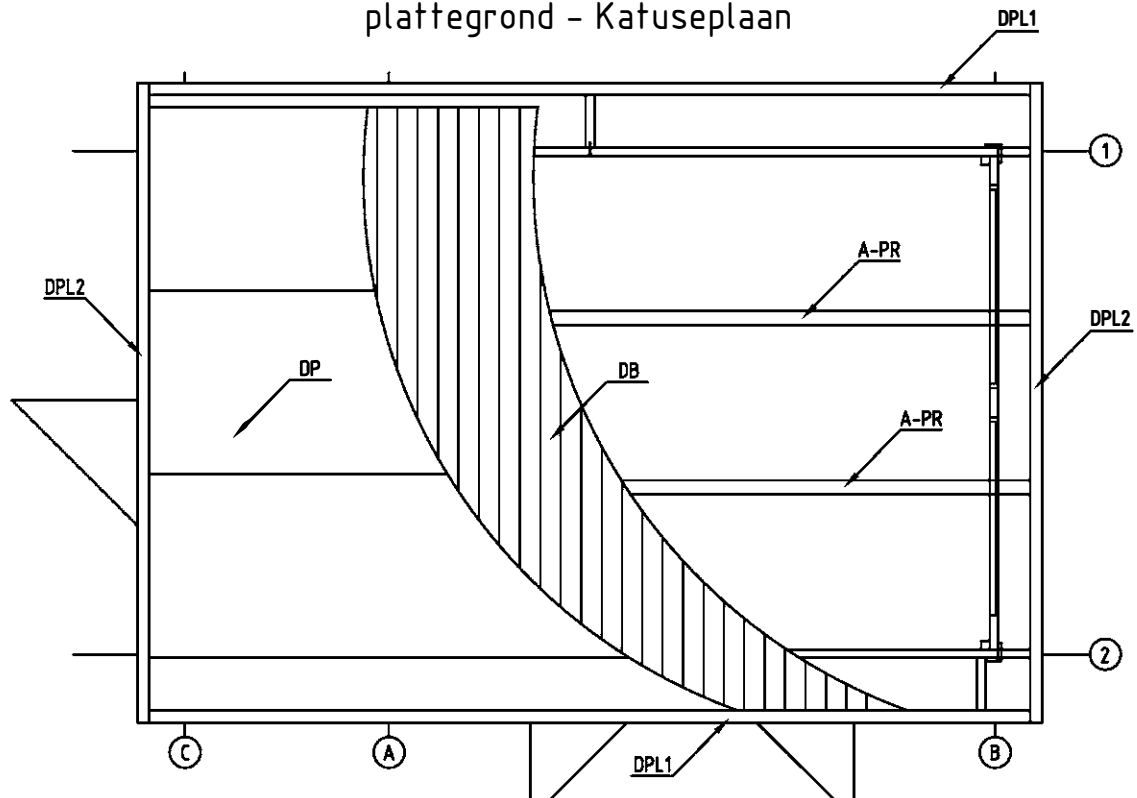

Tür- und Fenster-Details

231160

TUK.4.020.MVP.MMTb MGC
 Glass size - Glasgröße - Taille de la vitre -
 Misura del vetro - Glas afmeting - Klaasi mõõt :561x334
 1702

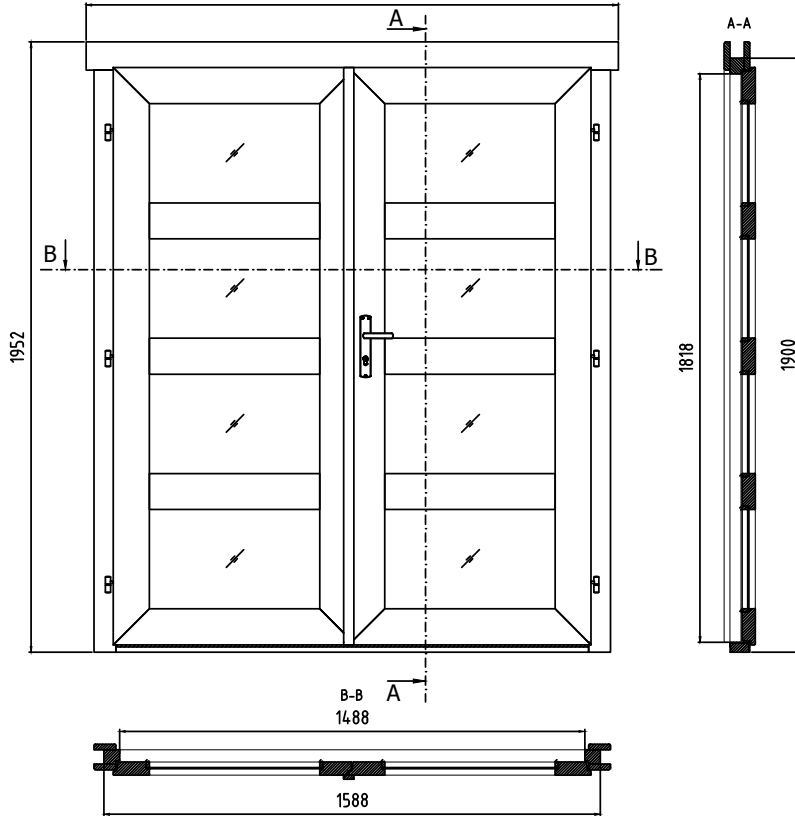

UL.2.100.IVV.MMWtd TC+0

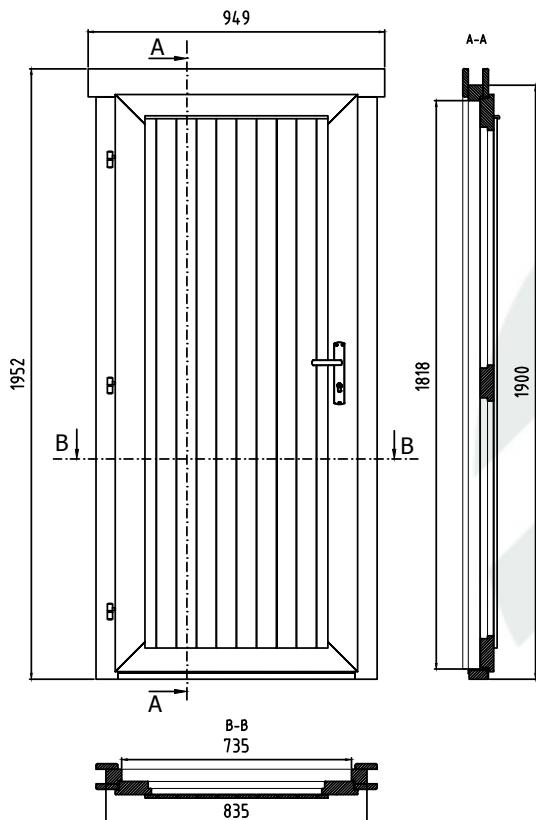



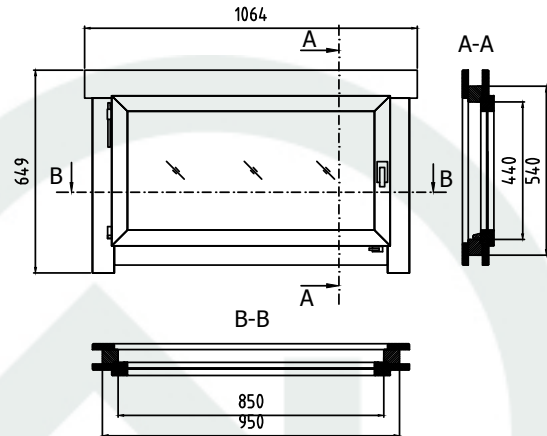





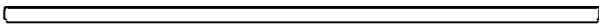
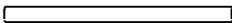

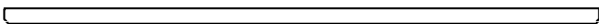

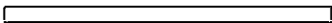
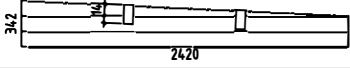
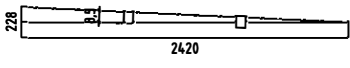

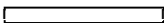
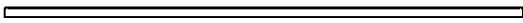

AK.1.100.MSV.d MGC
 Glass size - Glasgröße - Taille de la vitre -
 Misura del vetro - Glas afmeting - Klaasi mõõt 806x396
 1064

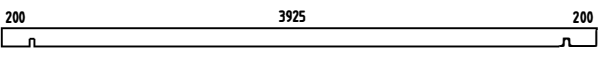















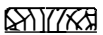

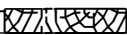

Teileliste 1

231160

Pos		Q	P (mm)	L (mm)
001		17	40x114	4000
002		1	40x114	4400
003		17	40x114	1683
004		17	40x114	683
005		1	40x114	4400
006		1	40x114	4400
007		1	40x71	2420
008		27	40x114	2420
WA-1		1		
WB-1 WC-1		1 1		
011		15	40x114	144
012		17	40x114	365
013		17	40x114	1174
IAR4	Foundation - Fundament - Fondation - Fondamenta - Fundering - Immutatud alusraam 	5	45x70	3830
IAR2	Foundation - Fundament - Fondation - Fondamenta - Fundering - Immutatud alusraam 	2	45x70	2420
IAR3	Foundation - Fundament - Fondation - Fondamenta - Fundering - Immutatud alusraam 	2	34x45	3988
IAR1	Foundation - Fundament - Fondation - Fondamenta - Fundering - Immutatud alusraam 	2	34x45	2420
PR21	Roof beam - Dachbalken - Panne de toit - Perlina del tetto - Gordingen / dakbalk - Pärilin 	2	70x140	4400
FB	Floor boards - Fussbodenbretter - Lame de plancher - Pavimento - Vloerhout - Põrandalaud 	44	90x18	2416
DB	Roof boards - Dachbretter - Voliges - Perlina per tetto - Dakhout - Katuselaud 	49	90x18	2988
	Floor fillet - Fussbodenleiste - Corniere de finition du plancher - Finitura per pavimento (battisco pa) - Vloerafwerklijst - Põrandaliist 		18x18	17.59
DL5	Batten - Deckleiste - Profils de finition angles a l'exterieur - Asse - Afdek lijst - Katteliist 	1	15x40	1970
DL4	Batten - Deckleiste - Profils de finition angles a l'exterieur - Asse - Afdek lijst - Katteliist 	1	15x40	2085

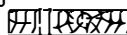
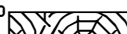
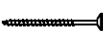
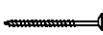

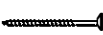
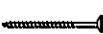



Teileliste 2

231160

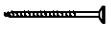
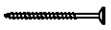
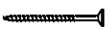
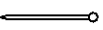
Pos		Q	P (mm)	L (mm)
DPL2	Roofing felt fillet - Dachpappenleiste - Baguette de fixation du feutre bitumeux - Asse per fissaggio guaina bituminosa - Afdekljst asfaltpapier - Katusepapiilist 	2	18x58	3136
DPL1	Roofing felt fillet - Dachpappenleiste - Baguette de fixation du feutre bitumeux - Asse per fissaggio guaina bituminosa - Afdekljst asfaltpapier - Katusepapiilist 	2	18x58	4320
DPP-1	Roofing felt (strip) - Dachpappe (bahnen) - Feutre bitumeux (bande) - Cartone catramato - Asfaltpapier (baan) - Katusepapp 	4		4700
FT	Fillet - Leiste - Lattes - Massellino di guarnizione per ringhiera - Lijst - Liist lävepaku alla 	1	12x34	835
FT	Fillet - Leiste - Lattes - Massellino di guarnizione per ringhiera - Lijst - Liist lävepaku alla 	1	12x34	1588
DL2	Corner fillet - Deckleiste - Profils de finition angles a l'exterieur - Massello d'angolo - (hoek)lijst - Nurgaliist 	2	18x70	2052
DL1	Corner fillet - Deckleiste - Profils de finition angles a l'exterieur - Massello d'angolo - (hoek)lijst - Nurgaliist 	2	18x70	2166
DL3	Corner fillet - Deckleiste - Profils de finition angles a l'exterieur - Massello d'angolo - (hoek)lijst - Nurgaliist 	4	18x90	1938
EP2	Corner stud - Eckpfosten - Poteaux d'angle pour fixation des madriers - Perno angolare - Hoek staander (kolom) - Nurgapost 	3	44x44	1970
EP1	Corner stud - Eckpfosten - Poteaux d'angle pour fixation des madriers - Perno angolare - Hoek staander (kolom) - Nurgapost 	3	44x44	2085
DRV	Roof edge reinforcement - Dachrandverstärkung - Corniere de renfort de bord de toit - Rinforzo x tetto - Dakrand versterking - Räästaturgevdus 	2	28x34	2177
TL2	Fixing fillet - Fixierungsleiste - Profil de fixation - Massello di fissaggio - Bevestiging lijtwerk - Tenderliist 	4	18x40	550
TL1	Fixing fillet - Fixierungsleiste - Profil de fixation - Massello di fissaggio - Bevestiging lijtwerk - Tenderliist 	4	18x40	1910
BL	Fixing slat for distance spacers - Befestigungsleiste - Renforts planches de rives - Stecca per fissare i distanziatori - Bevestigingslat afstandhouders - Viilulaua kinnitus 	8	28x34	250
DS	Distance spacers for gable moulding - Dachstützen - Supports extension toiture - Distanziatori per la modanatura del timpano - Daksteun / afstand houder - Viilulaua tugiklots 	4	44x140	307
GL2	Gable moulding - Giebelleiste - Planche de rive - Finitura per frontale e retro del tetto - Gevellijst - Viilulaud 	6	18x90	3100
GL1	Gable moulding - Giebelleiste - Planche de rive - Finitura per frontale e retro del tetto - Gevellijst - Viilulaud 	6	18x90	4436
HS6	Screw for gable moulding - Schrauben für giebelleiste - Vis pour fixation planche de rive - Vite per fissare finiture davanti e dietro del tetto - Schroef voor gevellijst - Krugi viilulauale 	80	3.5x50	
HS14	Screw for corner batten - Schrauben für deckleisten - Vis de fixation profils de finition angles a l'exterieur - Viti per stecca d'angolo - Schroef voor afdekljat - Krugi nurgaliistule 	56	3.5x35	
HS12	Screw for wall details - Schraube für wand details - Vis pour mur details - Viti per elementi della porta - Schroef voor wand details - Krugi seinte montaažiks 	370	4.5x80	
HS4	Screw for roof edge reinforcement - Schrauben für dachrandverstärkung - Vis pour fixation corniere renfort de bord de toit - Viti x rinforzo bordo tetto - Schroef voor dakrand versterking - Krugi räästaturgevdusele 	14	4x40	
HS4	Screw for fixing fillet of door and window - Schrauben für fixierungsleiste - Vis pour profil vertical de fixation pour ouvertures des fenetres et portes - Viti per massello di fissaggio - Schroeven voor bevestiging van deur en raam lijsten - Krugi tenderliistudele 	84	4x40	
HS4	Screw for distance spacer fixing slat - Schrauben für befestigungs-leiste - Vis de fixation renforts planches de rives - Viti per distanziatore della stecca di fissaggio - Schroef voor afstand houder lat - Krugi viilulaua kinnitusele 	16	4x40	

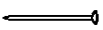

Teileliste 3

231160

Pos			Q	P (mm)	L (mm)
HS2	Screw for foundation - Schrauben zur Befestigung fundament - Vis de fixations des poutrelles de fondations - Viti x fondamenta - Schroef voor fundering - Kruvi alusraamile		14	4x60	
HS3	Screw for roof beams - Schrauben für Dachbalken - Vis pour fixation pannes de toit - Viti per perline del tetto - Schroef voor gordingen / dakbalken - Kruvi pärlinitele		6	5x120	
HS1	Screw for foundation - Schrauben zur Befestigung fundament - Vis de fixations des poutrelles de fondations - Viti x fondamenta - Schroef voor fundering - Kruvi alusraamile		10	5x90	
HS1	Screw for fixing gable moulding distance spacers to the wall - Schrauben für dachstützen - Vis de supports extension toiture - Viti per il fissaggio dei distanziatori del timpano dalla parete - Schroef voor bevestiging gevelpunt afstandhouder tot wand - Kruvi viilulaudade distantskloti kinnitamiseks seinale		8	5x90	
	Zn nail for floor fillet - Zn Nägel für Fussbodenteile - Pointe pour cornière de finition du plancher - Chiodi x fissaggio pavimento - Spijker(nagel) voor vloer afdekljst - Nael põrandalistule		36	1.4x40	
SH40	Hammer block - Schlagholz - Calle de frappe - Blocco di legno da usare come cuscinetto quando si usa il martello - Stagklos - Löögiklots		1		
DS1	Zn nail for roof - Zn Nägel für Dachbretter - Pointe pour fixation voliges de toit - Chiodi x perline tetto - Spijker(nagel) voor dakhout - Nael katuselauale		209	2x50	
DS1	Zn nail for floor - Zn Nägel für Fussbodenbretter - Clous pour plancher - Chiodi x perline pavimento - Spijker(nagel) voor vloer - Nael põrandalauale		225	2x50	
NF	Zn nail for roofing felt fillet - Zn Nägel für Dachpappenteile - Pointe pour baguette de fixation feutre bitumeux - Chiodi x carta bituminosa x tetto - Spijker(nagel) voor asfaltpapier afdekljst - Papiilistunael		36	2x40	
	Roofing nails for roofing felt - Nägel für Dachpappe - Pointe pour fixation feutre bitumeux - Chiodi per cartone catramato - Asphalt Nagel - Papinael		153	2.8x15	
	Window - Fenster - Fenetre - Finestra - Raam - Aken	950x540 AK.1.100.MSV.d MGC	2		
	Door - Tür - Porte - Porte - Deur - Uks	1588x1900 TUK.4.020.MVP.MMTb MGC	1		
	Door - Tür - Porte - Porte - Deur - Uks	835x1900 UL.2.100.IVV.MMWTd TC+0	1		



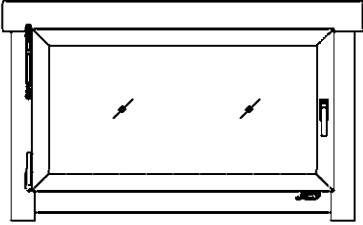
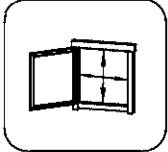

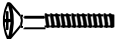

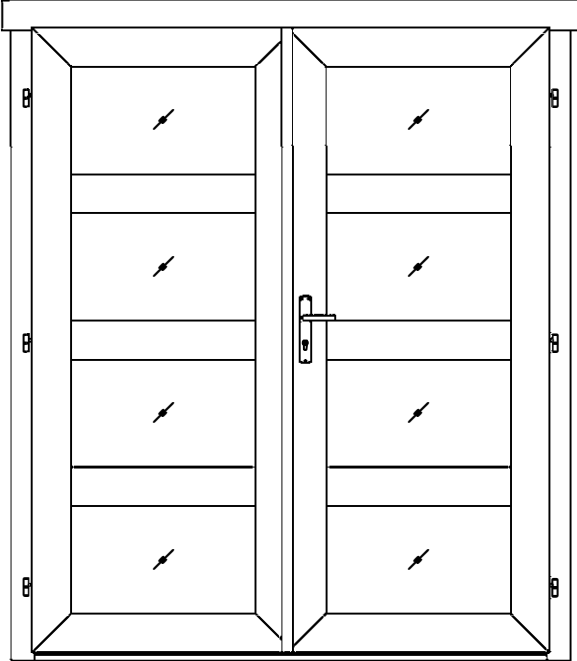
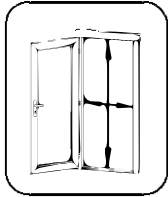

Teileliste 4

231160

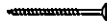
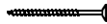
Pos		Q	P (mm)	L (mm)
	<p data-bbox="284 360 1166 387">Glass size - Glasgröße - Taille de la vitre - Misura del vetro - Glas afmeting - Klaasi mõõt: 806x396 mm</p> <div style="display: flex; justify-content: space-around; align-items: center;">  <div style="text-align: center;">  <p data-bbox="1246 533 1356 560">850x440 mm</p> </div> </div>			
FS1	<p data-bbox="284 2007 946 2056">Window handle fittings - Fenstergriff - Poignee de fenetre - Maniglia c/ferramenta - Raamhendel -/grendel -/klink - Aknalink</p>		1	
FSP	<p data-bbox="284 2074 1018 2136">Bolt for window handle fittings - Bolzen für fenstergriff beschlag - Vis pour fixation poignee de fenetre - Bullone x apertura manuale finestra - Schroef voor raamhendel - Akna käepideme polt</p>		2	







Teileliste 5

231160

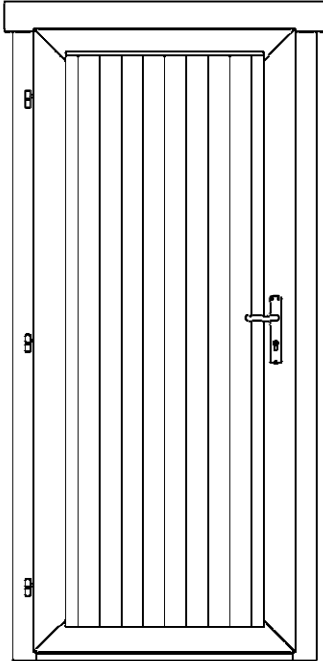
Pos		Q	P (mm)	L (mm)
	<p>Glass size - Glasgröße - Taille de la vitre - Misura del vetro - Glas afmeting - Klaasi mõõt: 561x334 mm</p>   <p>1488x1818 mm</p>			
HS4	<p>Screw for door fillet - Schraube zur Befestigung Türleiste - Vis pour fixation baguette d'arrêt de porte - Viti per massellino della porta - Schroef voor deurlijst - Kruvi ukse kokkuvaltšiliistule</p> 	5	3x30	
HS16	<p>Screw for door jamb - Schraube für Türrahmen - Vis de fixation partie haute avec montants du cadre de porte - Viti x fissaggio montanti porte - Schroef voor deurkozijn - Kruvi ukse lengile</p> 	4	5x90	
HS25	<p>Screw for doorstep - Schrauben für Swelle - Vis pour fixation barre de seuil - Vite per soglia della porta - Schroef voor deurdorpel - Kruvi lävepakule</p> 	3	4.5x65	
TL4	<p>Door handle fittings - Türgriff - Poignée de porte - Maniglie - Deurhendel / klink - Ukse käepide</p> 	1		
TL5	<p>Set of door lock covers - Schlossblenden - Set de garnitures de porte - Copertura serrature - Slot sluitplaat set - Ukse lukuplaat</p> 	1		
	<p>Cylinder lock - Zylinderschloss - Barillet de porte - Serratura - Cylinder slot - Ukse lukusüdamik</p> 	1	30x35	
	<p>Male bolt hinge for door - Türband - Partie male de paumelle de porte - Cerniera anube x porta - Scharnier bout - Ukse polthing isane</p> 	6		
	<p>Striker for barrel bolt - Hülse für Grendelriegel - Gache au sol du targette - Boccola per fermo della porta - Huls voor vergrendelingsschuif - Vasturaud ukse servariivile</p> 	2		

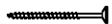
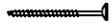
Teileliste 6

231160

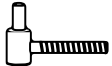
Pos		Q	P (mm)	L (mm)	
	  <p>735x1818 mm</p>				
HS25	Screw for doorstep - Schrauben für swelle - Vis pour fixation barre de seuil - Vite per soglia della porta - Schroef voor deurdorpel - Kruvi lävepakule		2	4.5x65	
HS16	Screw for door jamb - Schraube für türrahmen - Vis de fixation partie haute avec montants du cadre de porte - Viti x fissaggio montanti porte - Schroef voor deurkozijn - Kruvi ukse lengile		4	5x90	
TL4	Door handle fittings - Türgriff - Poignée de porte - Maniglie - Deurhendel / klink - Ukse käepide		1		
TL5	Set of door lock covers - Schlossblenden - Set de garnitures de porte - Copertura serrature - Slot sluitplaat set - Ukse lukuplaat		1		
	Cylinder lock - Zylinderschloss - Barillet de porte - Serratura - Cylinder slot - Ukse lukusüdamik		1	30x35	
	Male bolt hinge for door - Türband - Partie male de paumelle de porte - Cerniera anube x porta - Scharnier bout - Ukse polthing isane		3		

Wandpläne 1 und 2

231160

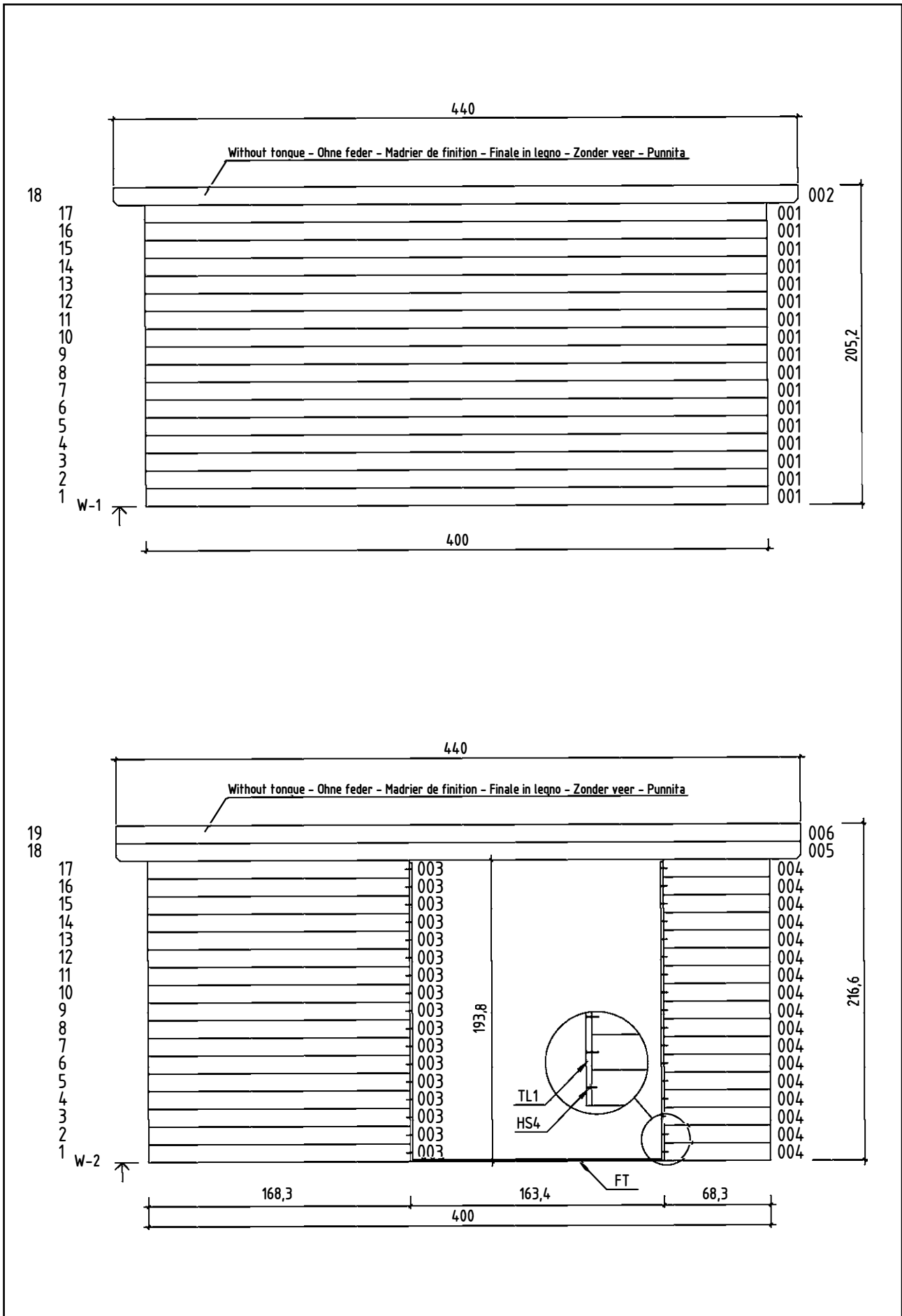

Wandpläne A, B und C

231160

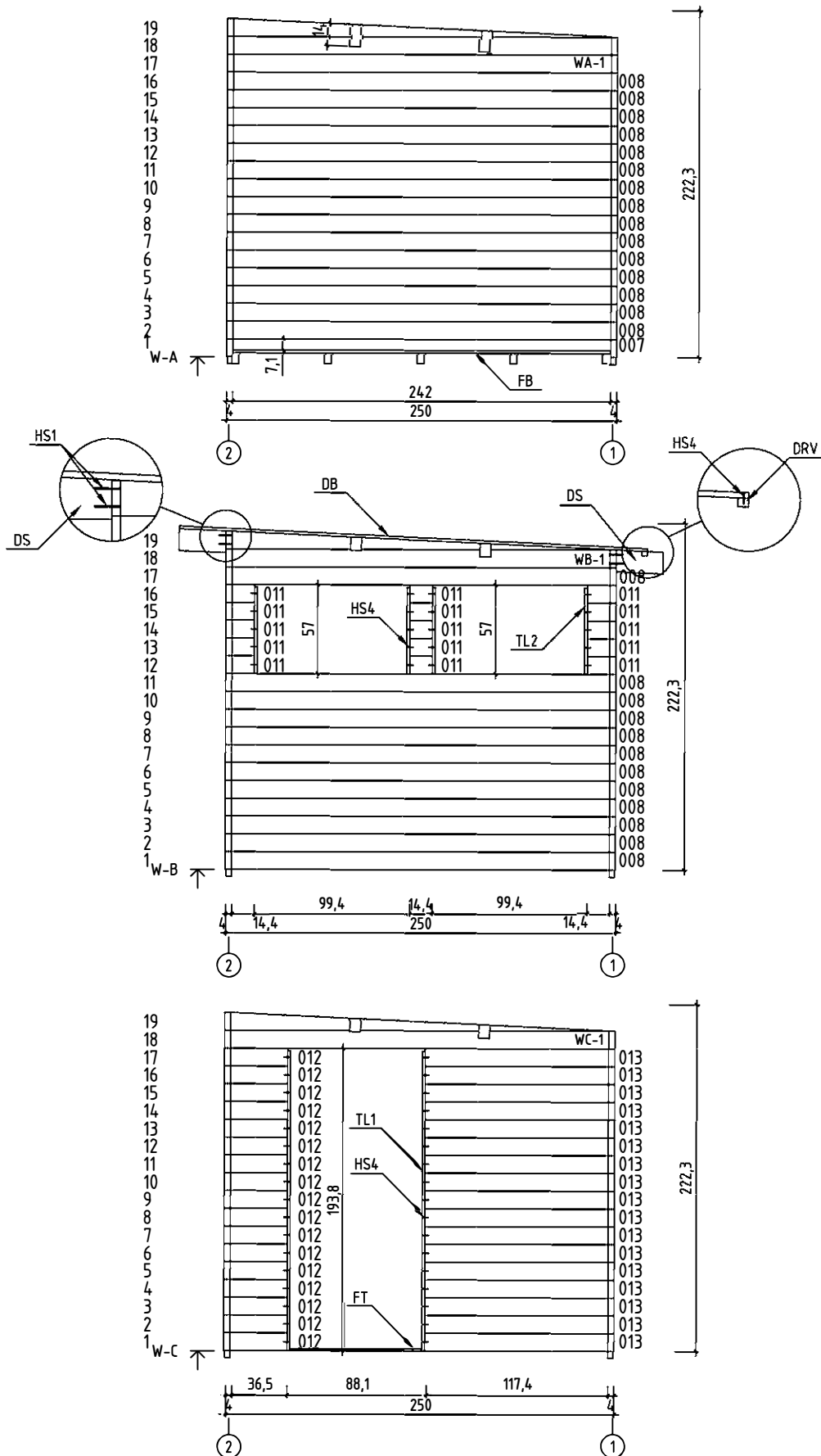

Montage 231160

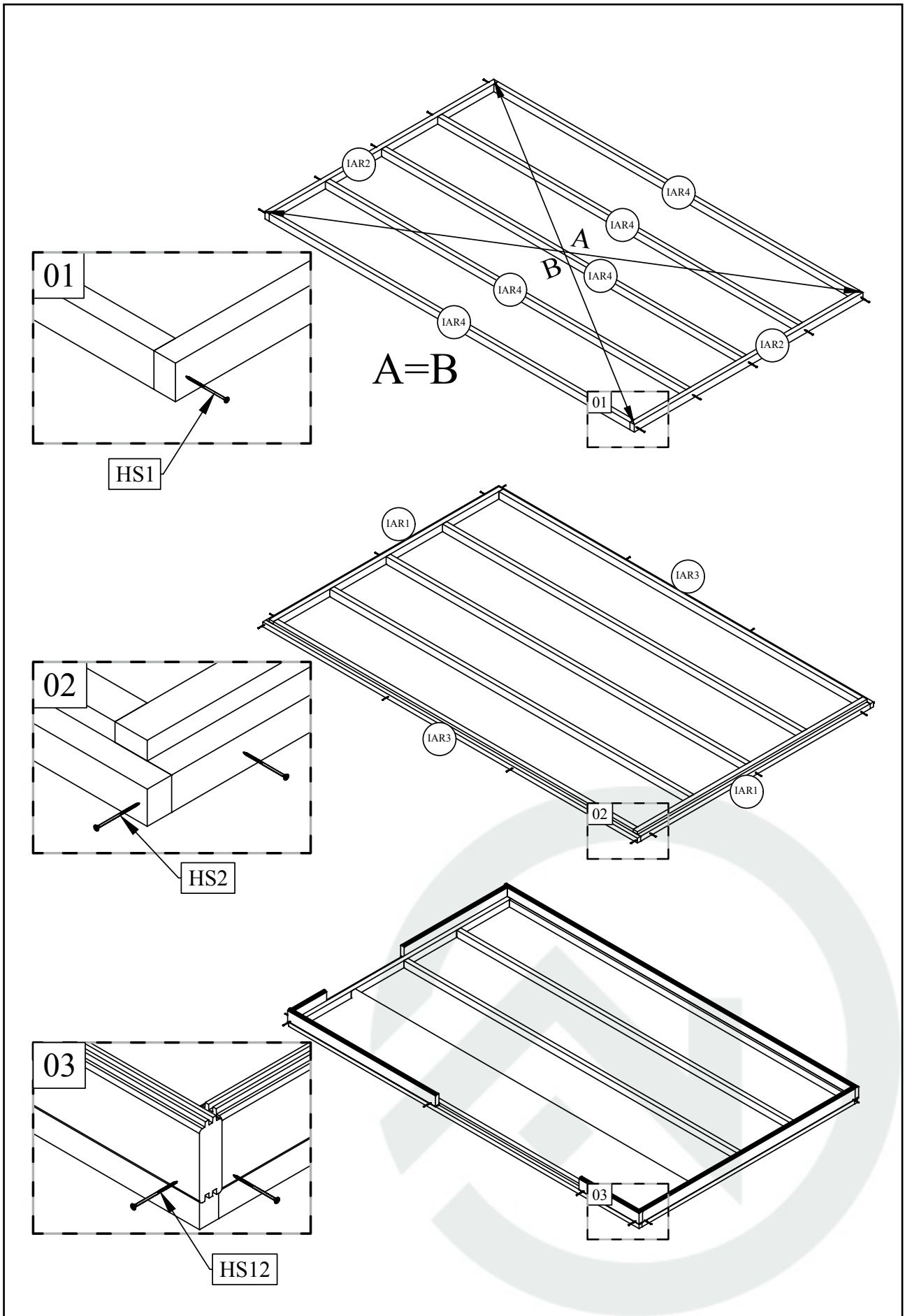

Montage 231160

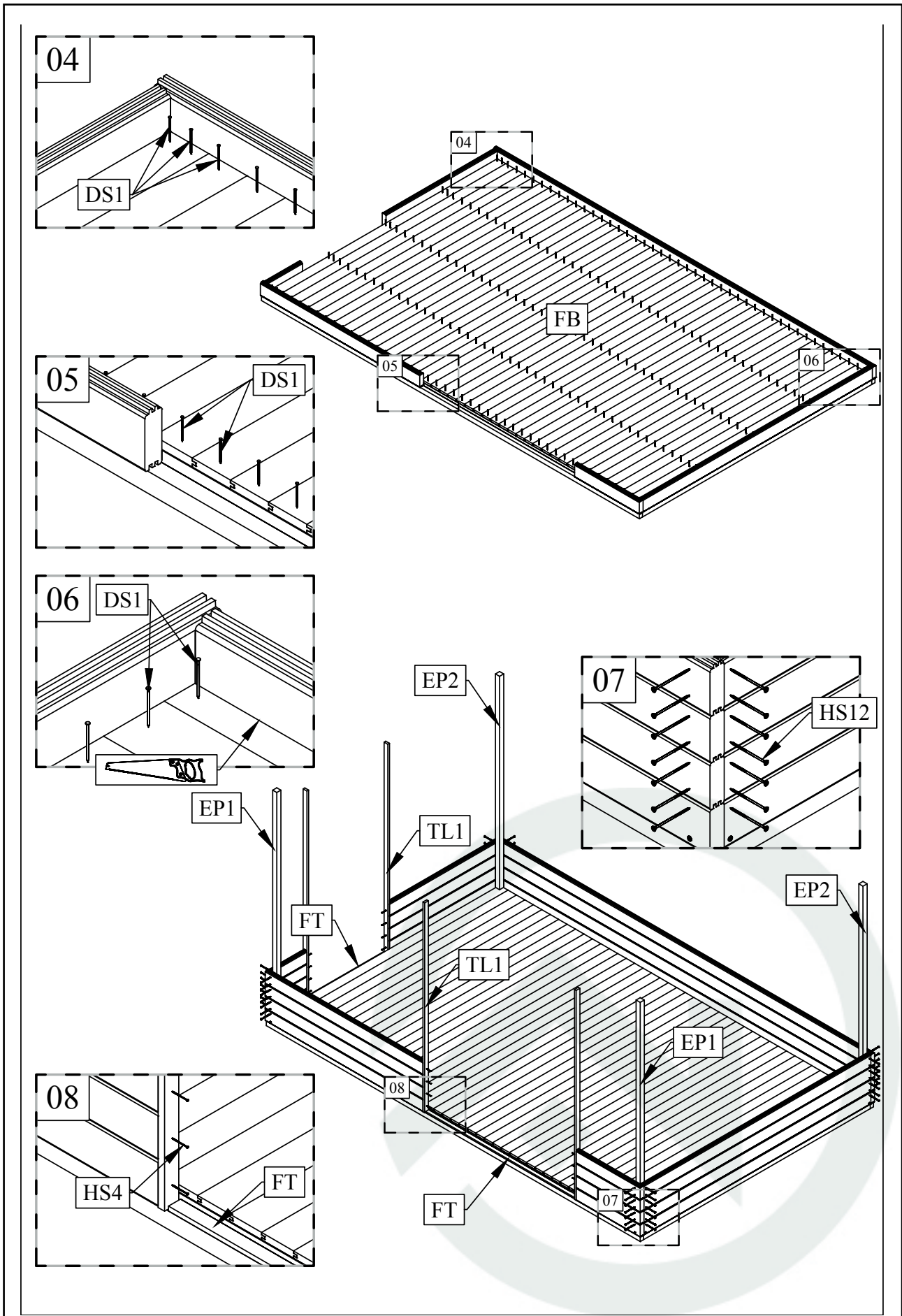

Montage 231160

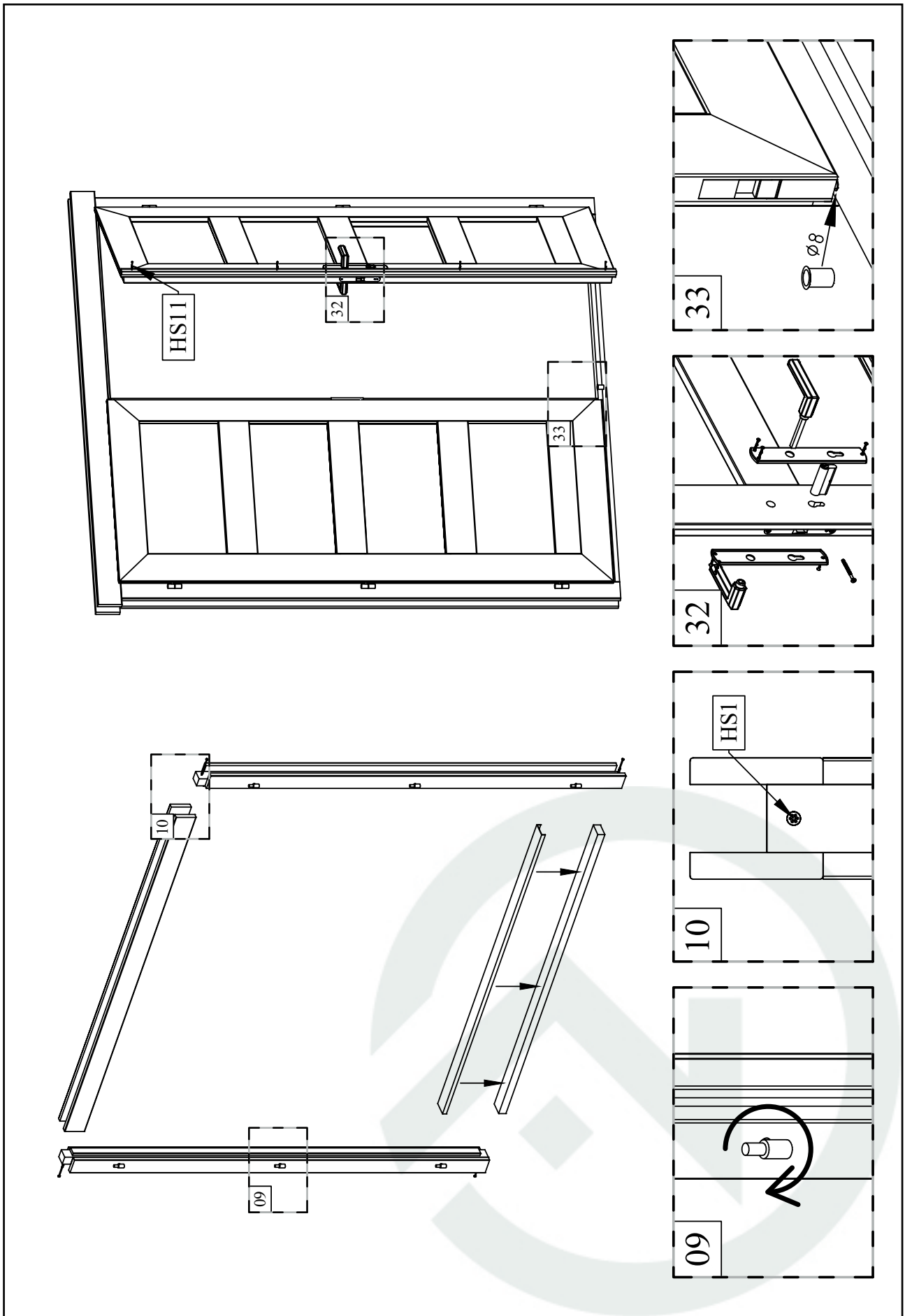

Montage 231160

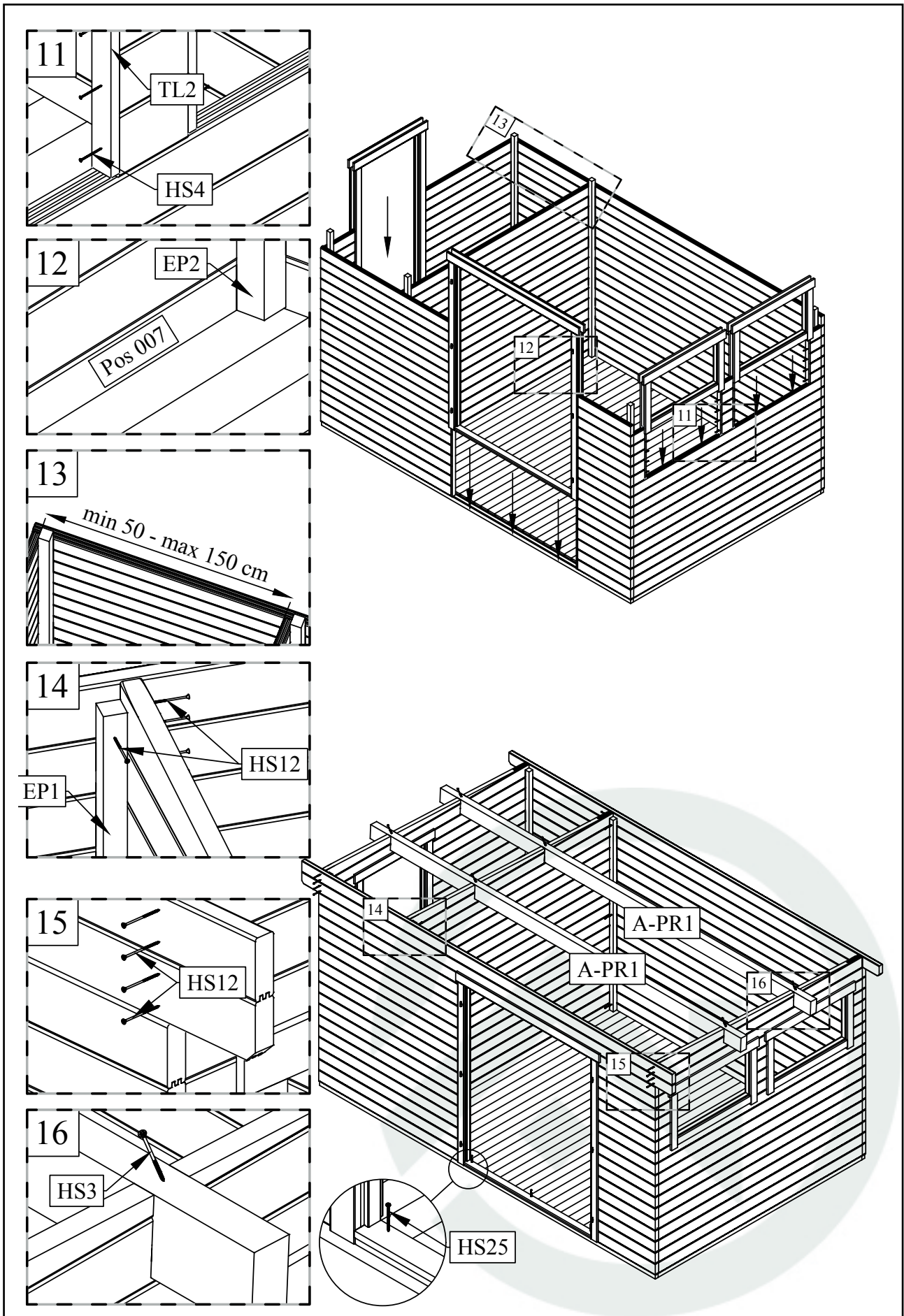

Montage 231160

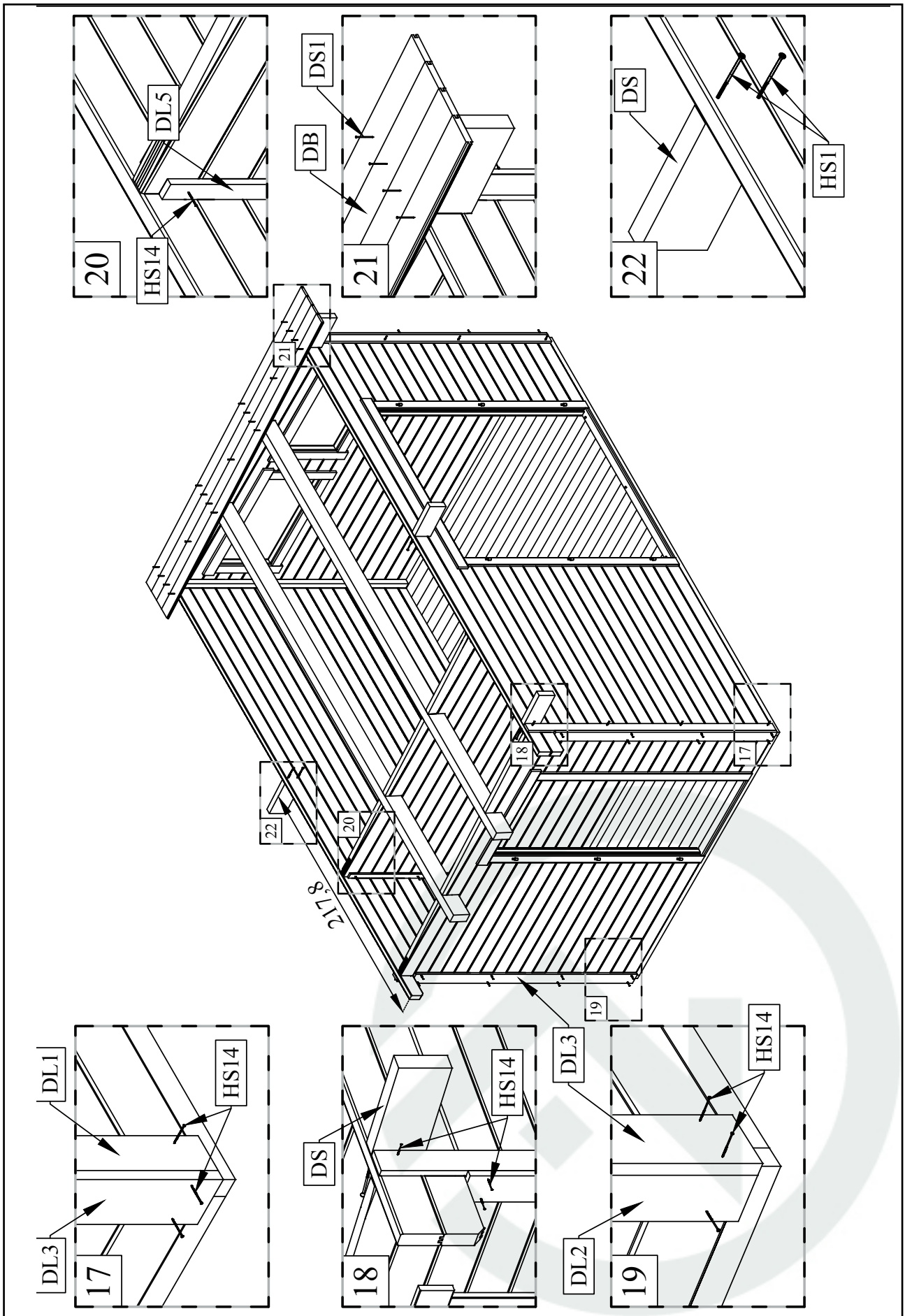

Montage 231160

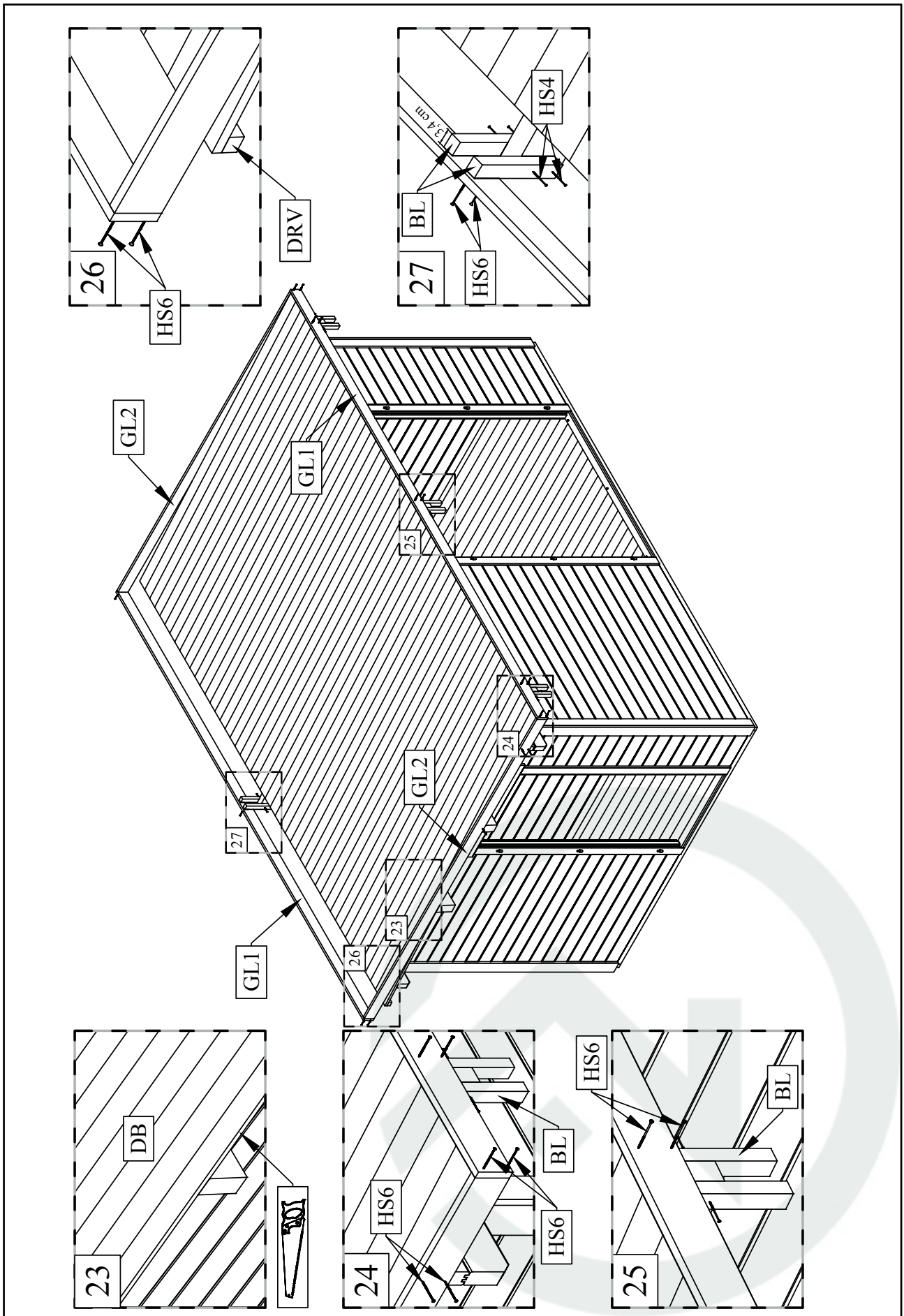

Montage 231160

