

Technische Daten

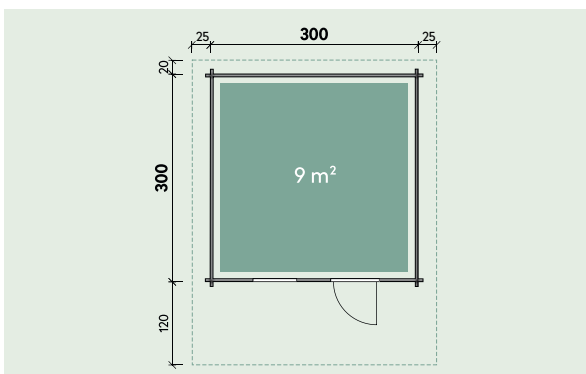

Artikelnummer:

234 040



Kontrolliert durch:

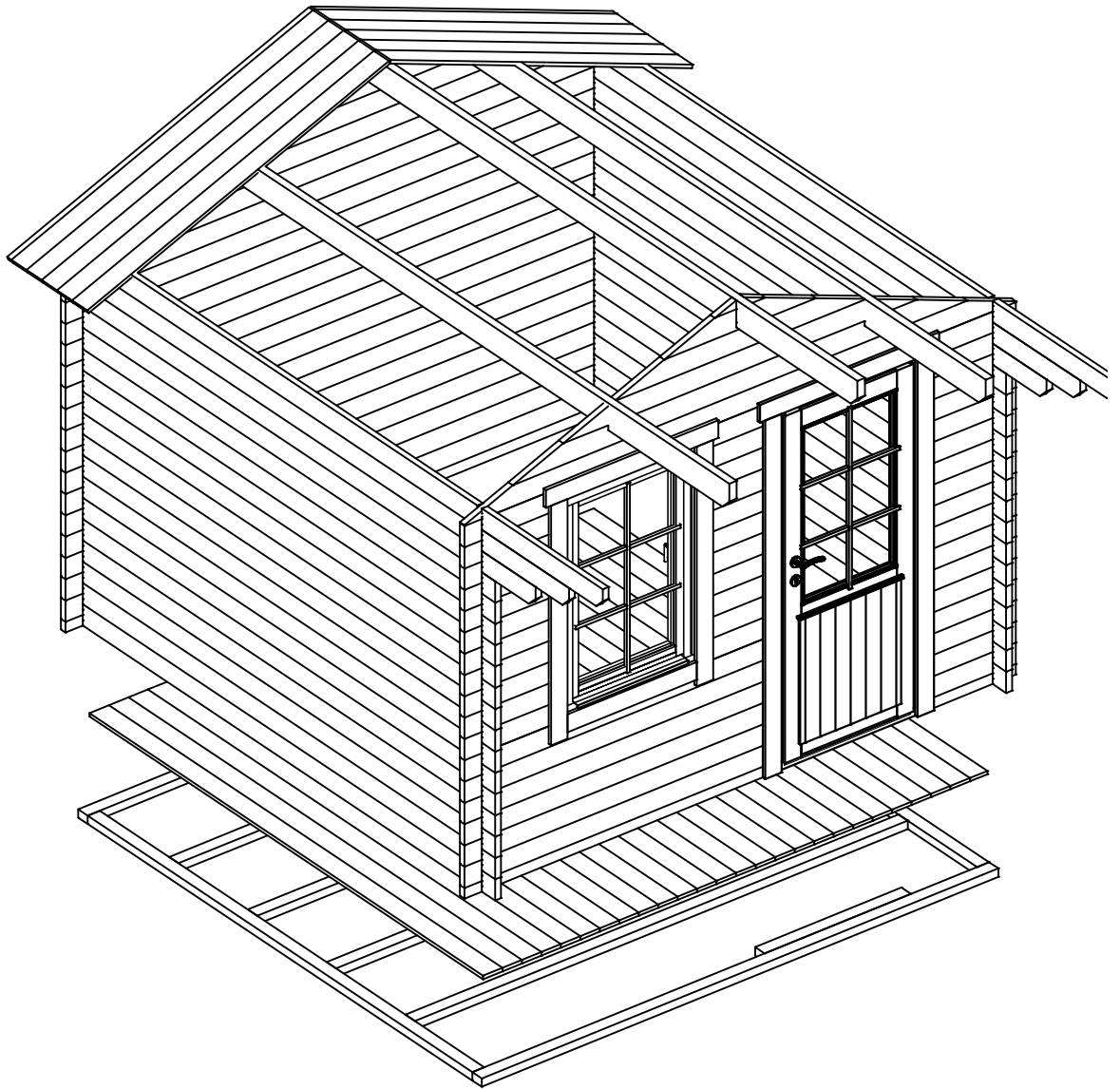

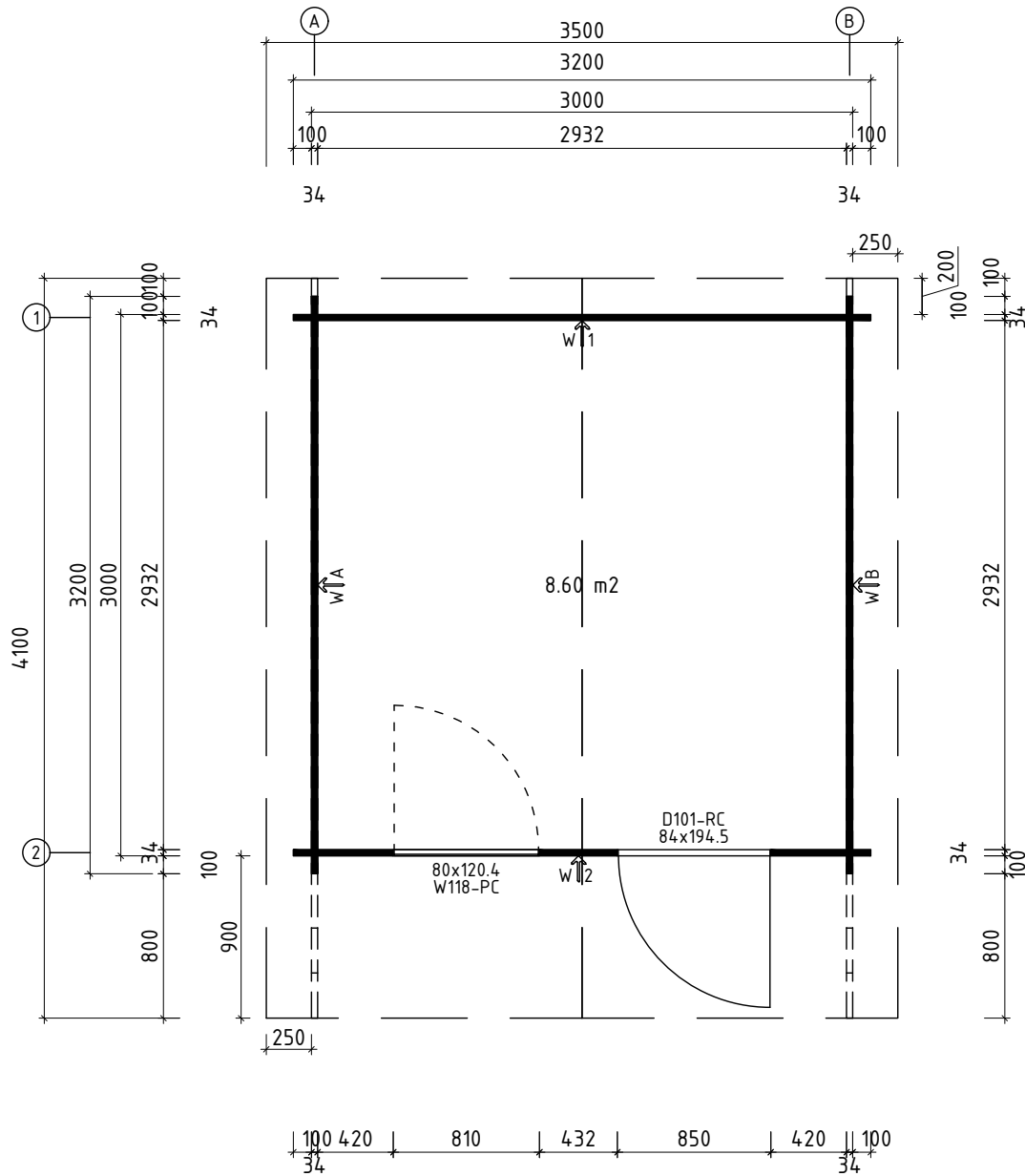







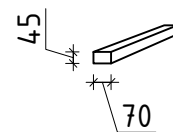
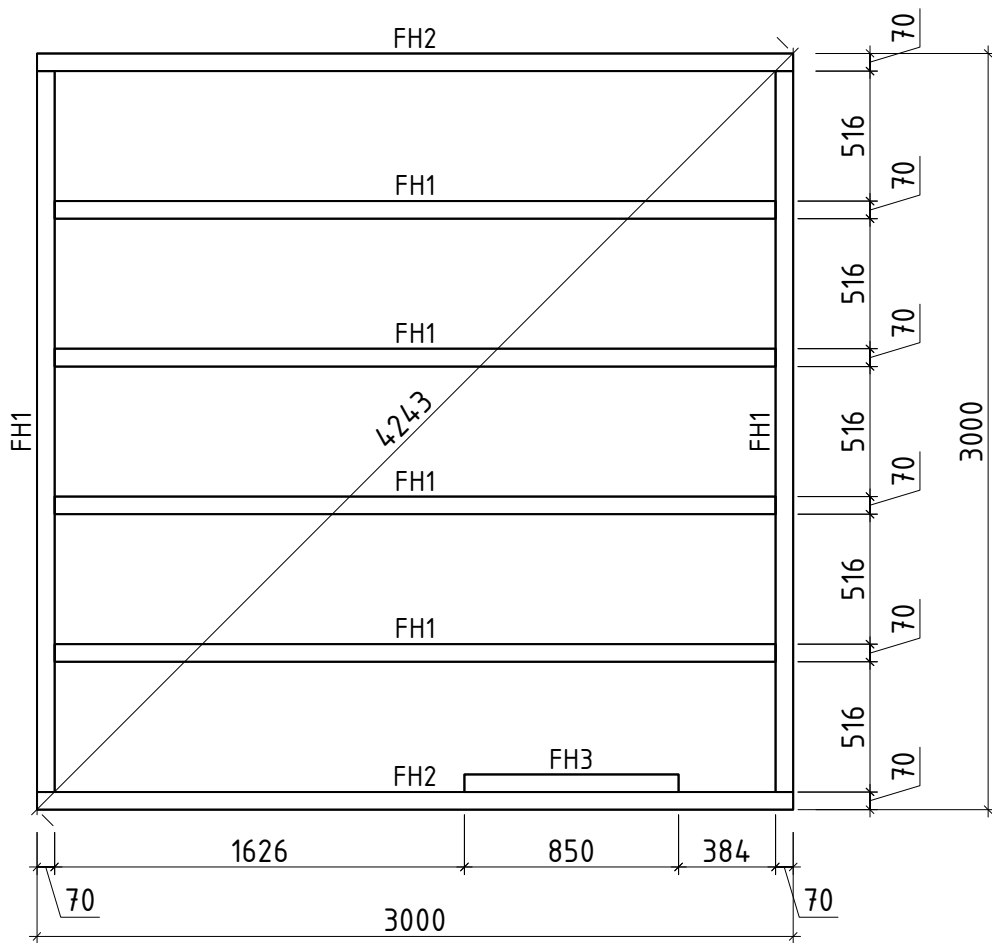



* Fenster und Türen sind mit Sprossen

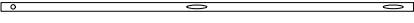

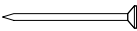



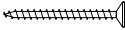
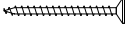
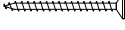

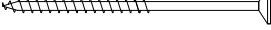
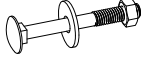

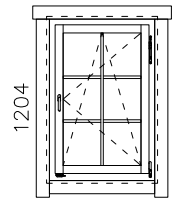
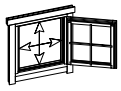
Q4 - Qualitätsklasse für Fenster und Türen







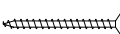

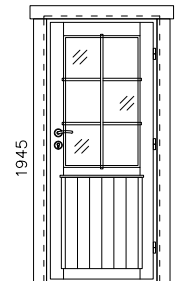

Wir empfehlen als Fundament für Ihr Gartenhaus eine vollflächig festgegründete, gepflasterte oder betonierte Fläche. Wahlweise ist auch ein Punkt- oder Streifenfundament möglich.

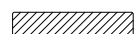

Nr.		Stck	Profil (mm)	Länge (mm)
001		1	34x114	4100
002		1	34x114	4100
003		2	34x114	3750
004		2	34x114	3500
006		47	34x114	3200
007		1	34x57	3200
010		1	34x57	1796
011		6	34x114	1796
014		28	34x114	554
015		1	34x57	554
016		11	34x114	432
W1-1		1		
W2-1		1		
FH2	FUNDAMENTHÖLZER (imprägniert) 	2	70x45	3000
FH1	FUNDAMENTHÖLZER (imprägniert) 	6	70x45	2860
FH3	FUNDAMENTHÖLZER (imprägniert) 	1	70x45	850
PF1	PFETTEN 	2	44x145	4100
PF2	PFETTEN 	1	44x145	4100
	DACHBRETTER	74+1	113x18	1880
	FUSSBODENBRETTER	26+1	113x18	2925
	FUSSBODENLEISTEN	✓	18x40	13.0lfm
G02-1	GIEBELBRETTER 18x120 21.2°	✓	18x120	1960
G06-1	GIEBELDECKLEISTEN 18x58	✓	18x58	1960

Nr.			Stck	Profil (mm)	Länge (mm)
T06-1	TRAUFENLEISTEN 18x40		4	18x40	2050
T01-1	TRAUFENBRETT 18x95		2	18x95	4100
SM-1	Sturmleisten		4	18x40	1940
GS	Giebelsegment		2		
SH	Schlaghölzer		3		
NG2 550	NÄGEL 2.5x50 Dachbretter		444		
NG2 550	NÄGEL 2.5x50 Fussbodenbretter		312		
SR3 030	SCHRAUBEN 3.0x30 Fussbodenleisten		22		
SR3 030	SCHRAUBEN 3.0x30 Traufendeckleisten		20		
SR3 545	SCHRAUBEN 3.5x45 Giebelbretter		16		
SR3 545	SCHRAUBEN 3.5x45 Giebeldeckleisten		16		
SR3 545	SCHRAUBEN 3.5x45 Giebelsegment		4		
SR3 545	SCHRAUBEN 3.5x45 Traufenbretter		20		
SR5 0100	SCHRAUBEN 5.0x100 Fundamenthölzer		36		
SS024	Schloßschrauben M8x70 Mutter M8 U-Scheibe Ø25 - Befestigung für Sturmleisten		12		
	✓ - bitte selber anpassen (falls nötig)!				

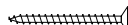
Nr.		Stck	Profil (mm)	Länge (mm)
	<p style="text-align: center;">FENSTER 800x1204 W4-S34P-06C-08001204</p> <div style="display: flex; justify-content: space-between;"> <div style="text-align: center;"> <p>Q4 W118-PC 800</p>  </div> <div style="border: 1px solid black; padding: 5px; width: 150px;"> <p>Right handed / DIN rechts / paremakäeline</p> </div> <div style="border: 1px solid black; padding: 5px; width: 150px;"> <p>Clear opening/ durchgangsmaß/ ava suurus</p>  <p>644x1031mm</p> </div> <div style="border: 1px solid black; padding: 5px; width: 150px;"> <p>double-pane clear float glass</p>  <p>ISO Glas 2-fach</p> <p>2x klaaspakett, kirgas klaas</p> <p>585x979mm</p> </div> </div>	1		
VP54 32-1	<p>Q4 Window sill - Fensterbank - Veeplekk</p> 	1		642
PROSS H41-1	<p>Q4-1 Muntins - Sprossen - Prossid horizontal 18x18</p> 	2	18x18	610
PROSS V42-1	<p>Q4-2 Muntins - Sprossen - Prossid vertical 18x18</p> 	1	18x18	1014
PL3-1	<p>Trims - Rahmenleisten - Piirdeliistud 18x95</p> 	2	18x95	1000
PL3-2	<p>Trims - Rahmenleisten - Piirdeliistud 18x95</p> 	4	18x95	1285
PL3-3	<p>Trims - Rahmenleisten - Piirdeliistud 18x95</p> 	2	18x95	760
SR30 22-01	<p>3.0x20ÜP Muntins - Sprossen - Prossid</p> 	6		
SR35 45-01	<p>3.5x45 Trims - Rahmleisten - Piirdeliistud</p> 	24		
AL-Q4	<p>Q4 Window handle - Fenstergriff - Aknalink</p> 	1		
	<p>✓ - bitte selber anpassen (falls nötig)!</p>			

Nr.		Stck	Profil (mm)	Länge (mm)
	<p style="text-align: center;">TÜR 840x1945 D4-S34R-56C-08401945</p> <div style="display: flex; justify-content: space-between;"> <div style="text-align: center;"> <p>Q4 D101-RC 840</p>  </div> <div style="border: 1px solid black; padding: 5px; width: 150px;"> <p>Right handed / DIN rechts / paremakäeline</p> </div> </div> <div style="display: flex; justify-content: space-between; margin-top: 10px;"> <div style="text-align: center;"> <p>Clear opening/ durchgangsmaß/ ava suurus 712x1837mm</p>  </div> <div style="border: 1px solid black; padding: 5px; width: 100px;">  </div> </div> <div style="display: flex; justify-content: space-between; margin-top: 10px;"> <div style="text-align: center;"> <p>double-pane clear float glass ISO Glas 2-fach 2x klaaspakett, kirgas klaas</p> </div> <div style="text-align: center;"> <p>549x950mm</p> </div> </div>	1		
PROSS H41-2	Q4-1 Muntins - Sprossen - Prossid horizontal 18x18 	2	18x18	574
PRO SS V42-2	Q4-2 Muntins - Sprossen - Prossid vertical 18x18 	2	18x18	975
PL3-4	Trims - Rahmenleisten - Piirdeliistud 18x95  ✓	4	18x95	1925
PL3-5	Trims - Rahmenleisten - Piirdeliistud 18x95  ✓	2	18x95	1040
SR30 22-01	3.0x20ÜP Muntins - Sprossen - Prossid 	6		
SR35 45-01	3.5x45 Trims - Rahmleisten - Piirdeliistud 	22		
LS-Q4	Q4 Cylinder lock - Zylinderschloss - Lukusüdamik 	1		
UL-Q4	Q4 Door handle - Türgriff - Ukselink 	1		
	✓ - bitte selber anpassen (falls nötig)!			

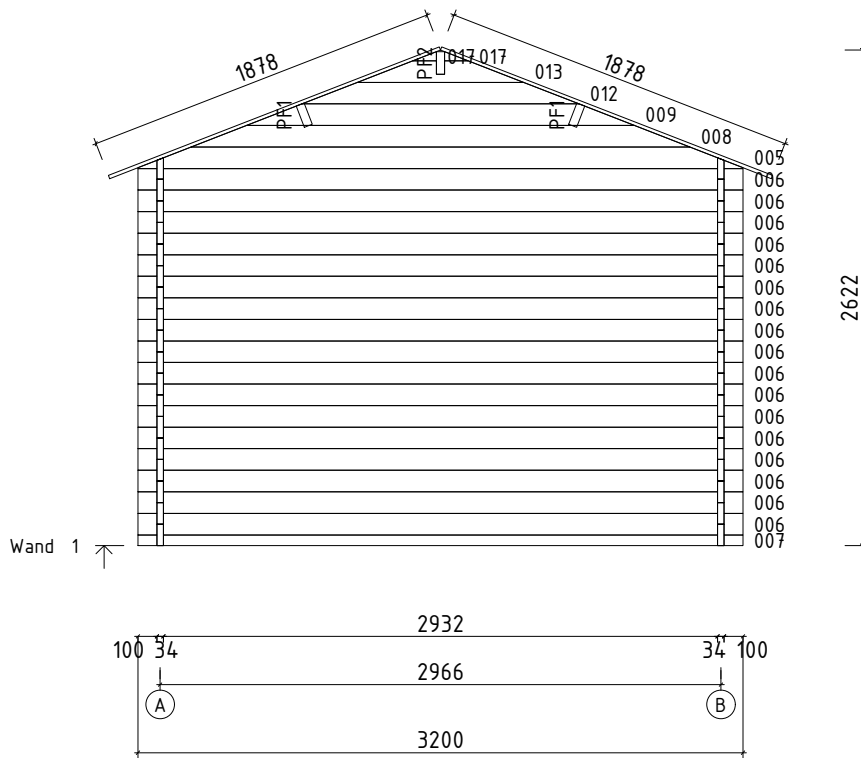

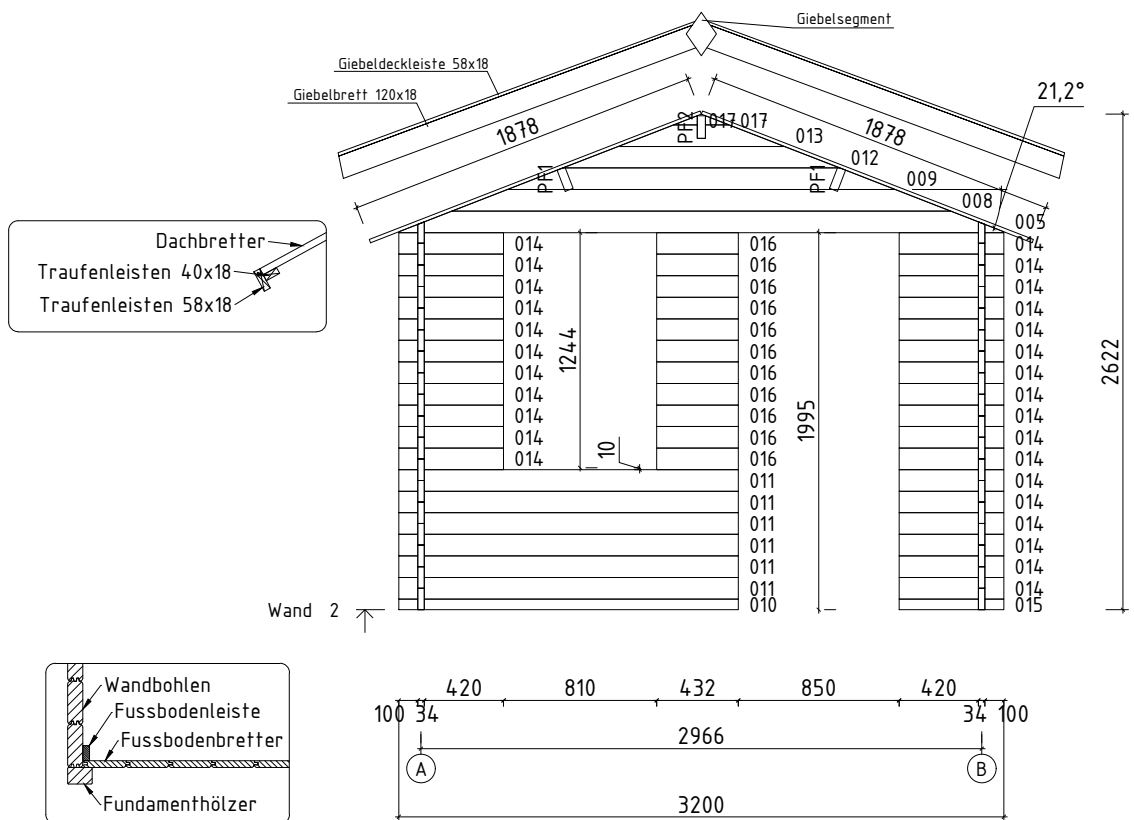

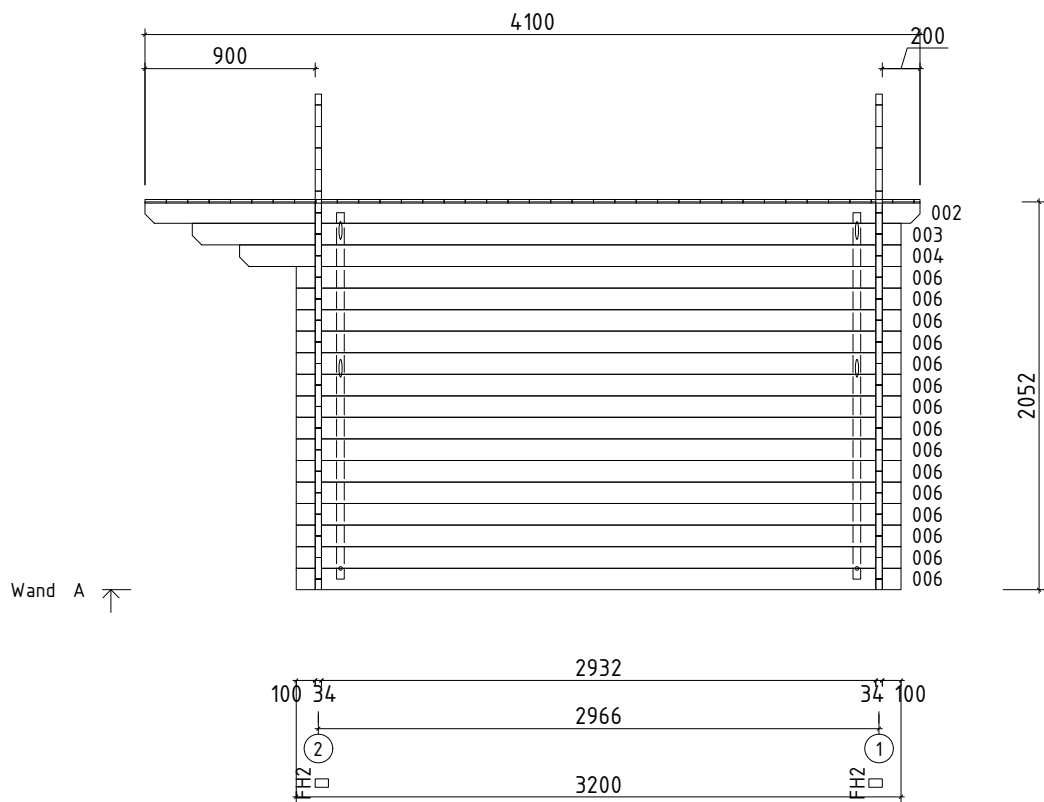

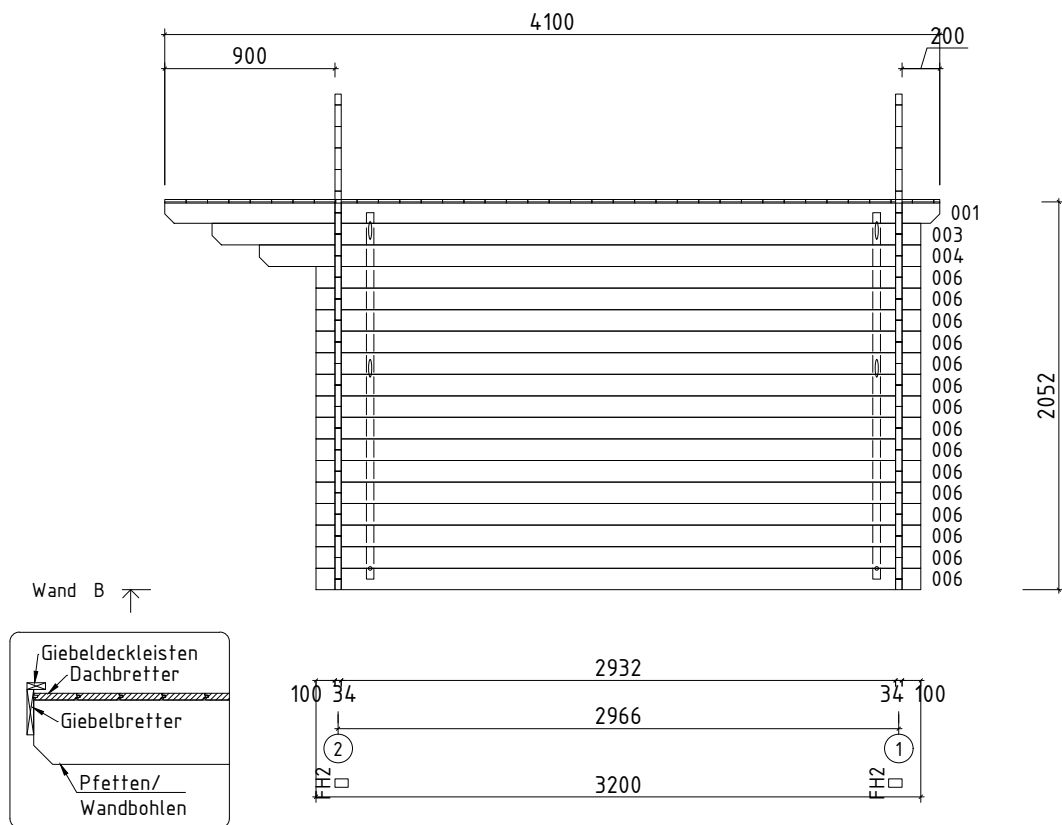

Aken Q4-Q6 - paigaldusjuhised
 Window Q4-Q6 - assembly instructions
 Fenster Q4-Q6 - Montageanleitung

