

# Technische Daten



Spiegelverkehrte Montage möglich. Durch Kunden farblich behandelt.

## Artikelnummer:

350 190

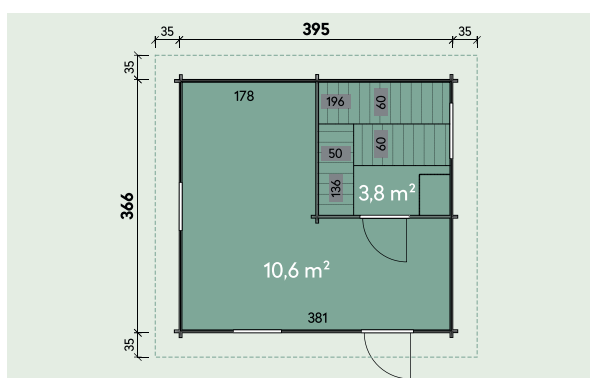

**Kontrolliert durch:**

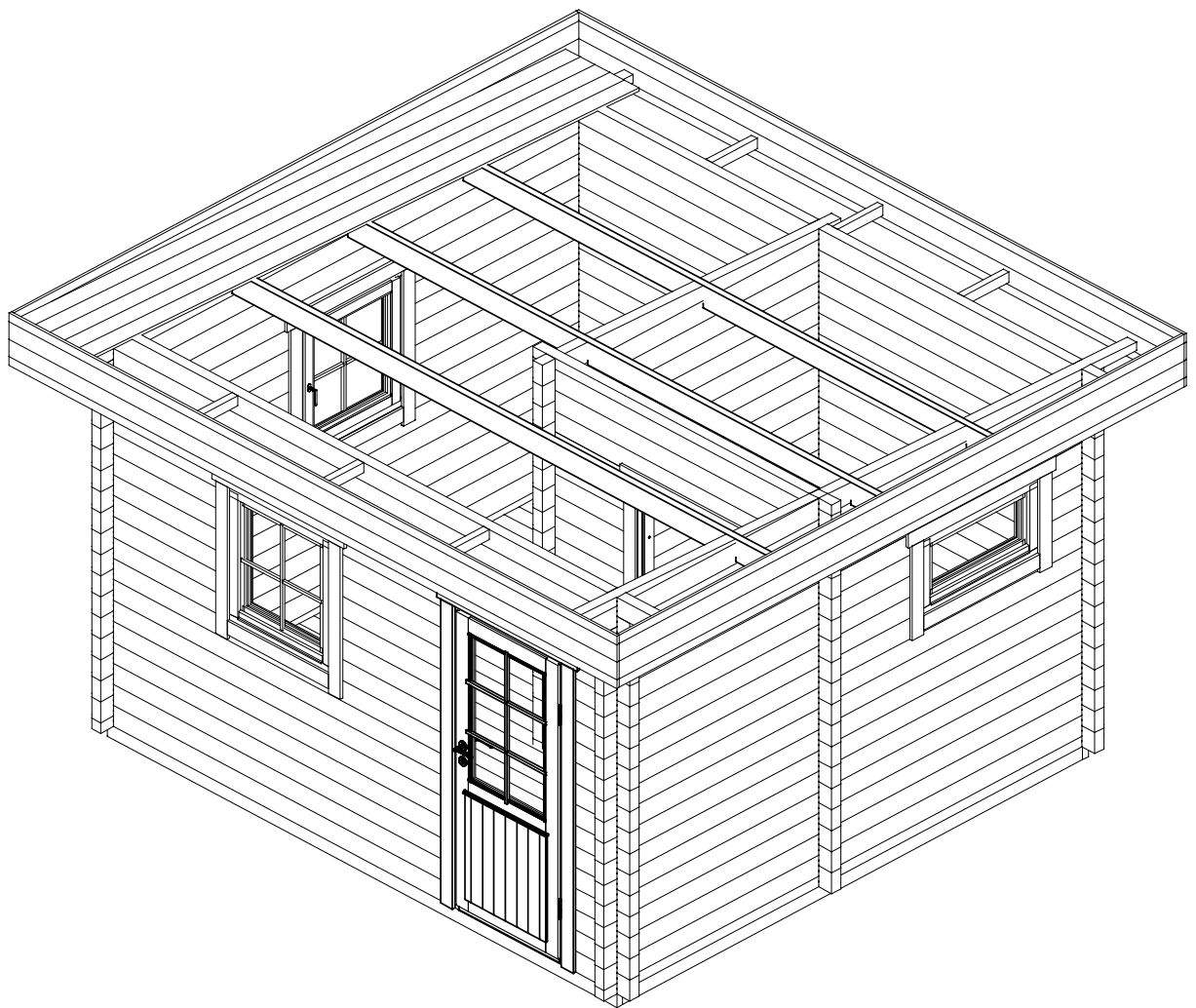

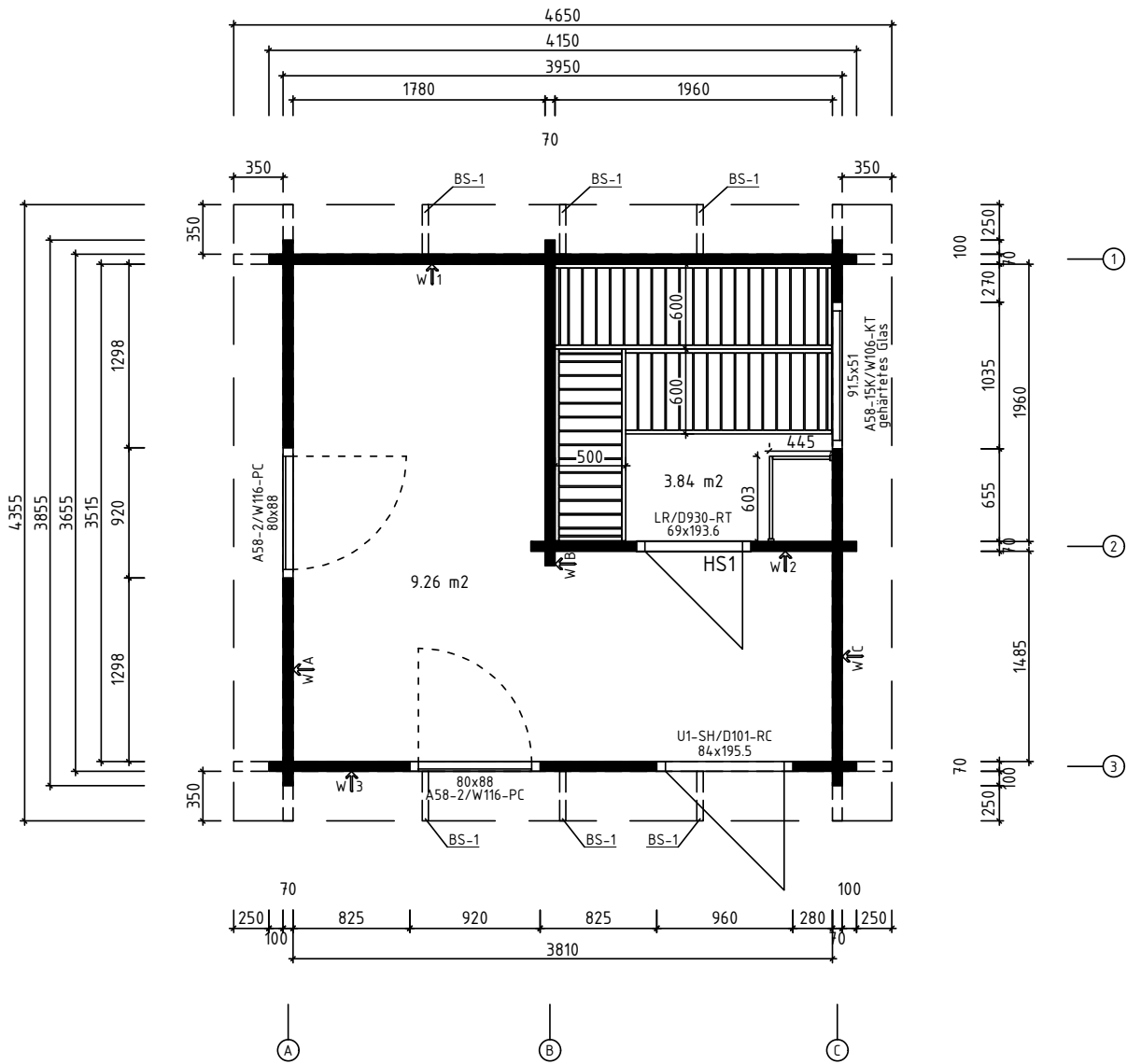







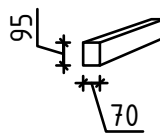
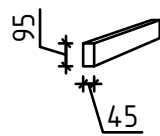
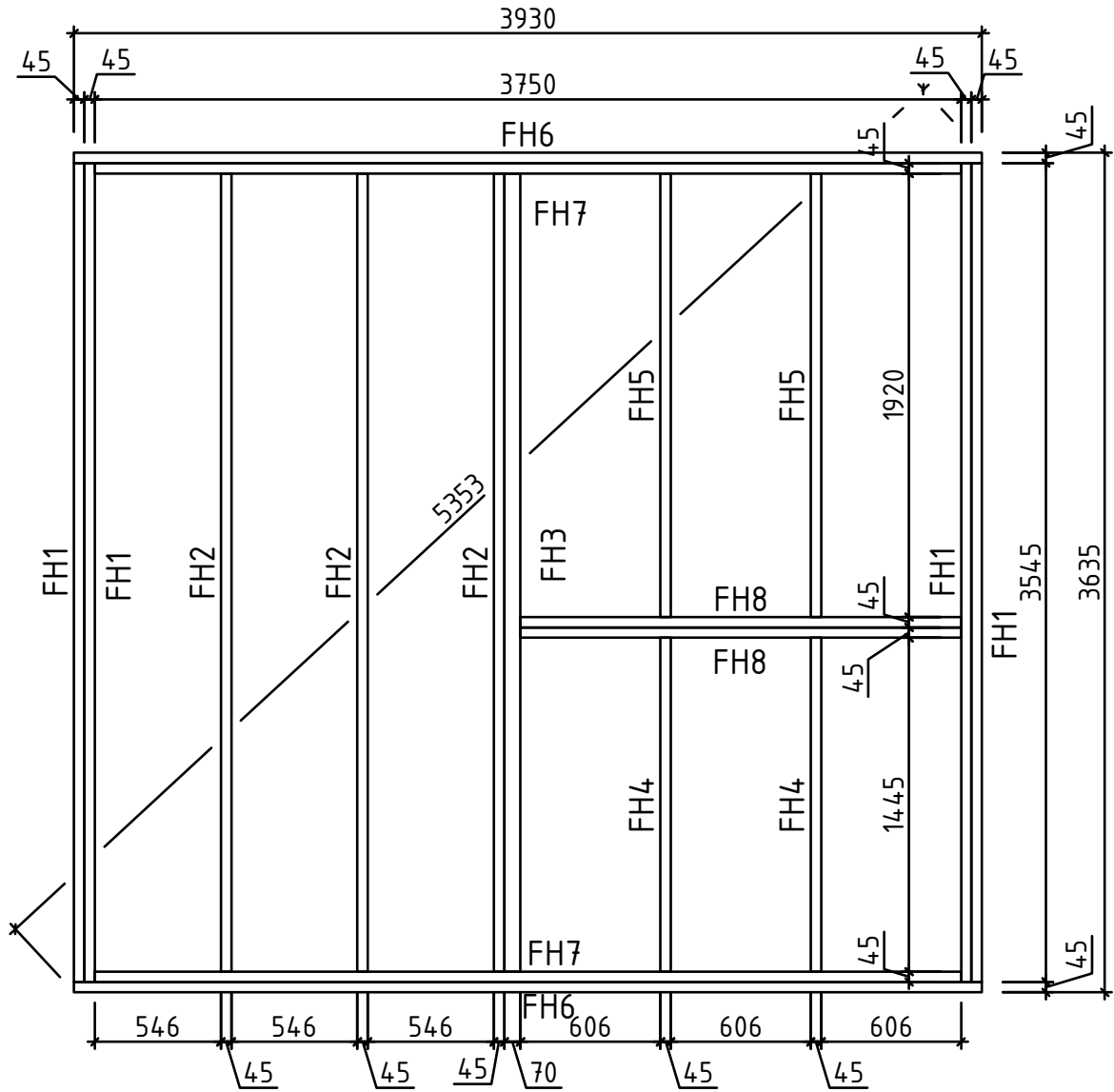



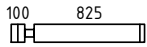
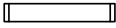
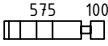
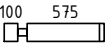



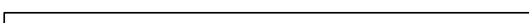
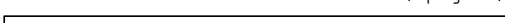
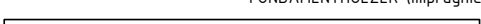

**Q4** – Qualitätsklasse für Fenster und Türen



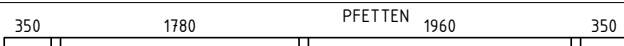
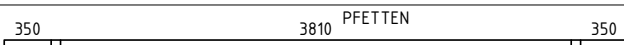
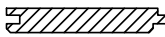





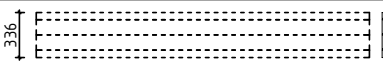







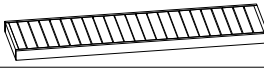
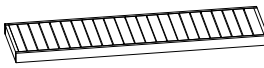

\*Fenster und Türen sind mit Sprossen

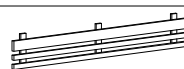

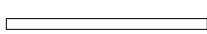



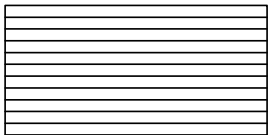
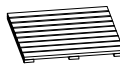
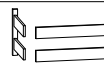
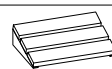
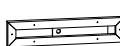















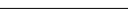

**Wir empfehlen als Fundament für Ihr Gartenhaus eine vollflächig festgegründete, gepflasterte oder betonierte Fläche. Wahlweise ist auch ein Punkt- oder Streifenfundament möglich.**



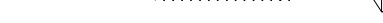



Pos		Stck.	Profil (mm)	Länge (mm)
	<b>Achtung!</b> Die Giebelbohlen können teilweise schon vormontiert sein! Bitte beachten - diese erscheinen nicht ganz so wie in der Teilleiste beschrieben.			
001		1	70x123	4650
002		1	70x135	4650
003		1	70x135	4355
004		1	70x135	4355
005		3	70x135	4150
006		15	70x135	4150
007		2	70x135	4150
008		11	70x135	3855
009		1	70x135	3855
010		1	70x135	3855
011		1	70x68	3855
012		9	70x135	3855
013		1	70x135	3855
014		1	70x135	3855
015		1	70x68	3855
016		7	70x135	2740
017		1	70x135	2740
018		4	70x135	2380
019		1	70x135	2300
020		1	70x70	2300
021		20	70x135	2300
022		1	70x68	2300
023		1	70x68	1968
024		1	70x68	1905
025		12	70x135	1468

Pos		Stck	Profil (mm)	Länge (mm)
026		7	70x135	995
027		7	70x135	825
028		14	70x135	745
029		16	70x135	745
030		15	70x135	450
031		4	70x135	440
FH3	FUNDAMENTHÖLZER (imprägniert) 	1	70x95	3455
FH6	FUNDAMENTHÖLZER (imprägniert) 	2	45x95	3930
FH7	FUNDAMENTHÖLZER (imprägniert) 	2	45x95	3750
FH1	FUNDAMENTHÖLZER (imprägniert) 	4	45x95	3545
FH2	FUNDAMENTHÖLZER (imprägniert) 	3	45x95	3455
FH5	FUNDAMENTHÖLZER (imprägniert) 	2	45x95	1920
FH8	FUNDAMENTHÖLZER (imprägniert) 	2	45x95	1908
FH4	FUNDAMENTHÖLZER (imprägniert) 	2	45x95	1445
HS1	HOLZSCHWELLE (unter der Saunatur) 	✓ 1	75x28	750
PF1	PFETTEN 	2	44x145	4650
PF2	PFETTEN 	1	44x145	4650
	DACHBRETTNER 	42+1	113x18	4260
	FUSSBODENBRETTNER 	14+1	113x28	3805
	FUSSBODENBRETTNER 	18	113x28	1955
	FUSSBODENBRETTNER 	18	113x28	1775
	FUSSBODENLEISTEN 	✓	14x55	23,0 lfdm
	DECKENLEISTEN 	✓	15x28	18,0 lfdm
BL-1	DACHBLENDEN 336mm 	2	18x336	4355
BL-2	DACHBLENDEN 336mm 	2	18x336	4686

Pos		Stck	Profil (mm)	Länge (mm)	
BS-1	DACHBLENDEN- Blendenstützen 44x65 	6	44x65	350	
UPB-1	DACHBLENDEN- U-Profil für Blenden 	✓	65x44	19,0 lfdm	
DPL-1	DACHPAPPENLEISTEN 15x28 	✓	15x28	14,0 lfdm	
T06-1	TRAUFENLEISTEN 18x40 	✓	18x40	10,0 lfdm	
TL70-1	T-LEISTE 70 	2	45x70	490	
TL70-2	T-LEISTE 70 	2	45x70	760	
TL70-3	T-LEISTE 70 	2	45x70	895	
TL70-4	T-LEISTE 70 	4	45x70	1975	
SA02-1	SAUNA - Saunabank 50cm 	1	500x90	1355	
SA01-1	SAUNA - Saunabank 60cm 	2	600x90	1955	
SA15-2-1	SAUNA - Rücklehne 2 	2	72x250	1860	
SA16-2-1	SAUNA - Bänke Zwischenstück 2 	1	46x300	1955	
SA10-1	SAUNA - Trägleiste für Saunabänke 	✓	3	30x40	600
SA10-2	SAUNA - Trägleiste für Saunabänke 	✓	2	30x40	1200
SA11-1	SAUNA - Stützpfeiler für Saunabänke 	✓	1	44x65	500
SA11-2	SAUNA - Stützpfeiler für Saunabänke 	✓	2	44x65	1000
SA20-1	SAUNA - Trägleiste für Deckenisolation 	✓	4	35x35	2000
	DECKENISOLATION 	2 Elemente		ca 1950x975	
SA37	SAUNA - Bodenrost 	1			
SA30	SAUNA - Heizung Umbau (set 1) 	1			
SA35	SAUNA - Kopfstütze 	2			
SA36	SAUNA - Luftschieber 	3			
SH	Schlaghölzer 	3			

Pos			Stck	Profil (mm)	Länge (mm)
KP-1	DACHPAPPE		✓	5,4m-6st.	34,0 lfdm
NG01	DACHPAPPNÄGEL 2.8x15		420		
NG2 550	NÄGEL 2.5x50 Dachbretter		420		
SR4 257	SCHRAUBEN 4.2x55 C2 Fussbodenbretter Holzschwelle		299		
SR3 030	SCHRAUBEN 3.0x30 Dachpappeleisten		28		
SR3 030	SCHRAUBEN 3.0x30 Deckenleisten		32		
SR3 030	SCHRAUBEN 3.0x30 Fussbodenleisten		46		
SR303 0-002	SCHRAUBEN 3.0x30 Sauna- Bänke Zwischenstück		6		
SR303 0-001	SCHRAUBEN 3.0x30 Sauna- Luftschieber		18		
SR3 030	SCHRAUBEN 3.0x30 Traufenleisten		20		
SR354 5-002	SCHRAUBEN 3.5x45 Sauna- Heizung Umbau		8		
SR3 547	SCHRAUBEN 3.5x45 C3 Fenster- und Türleisten		122		
SR3 547	SCHRAUBEN 3.5x45 C3 U-Profil		38		
SR406 0-001	SCHRAUBEN 4.0x60 Sauna- Trägleiste für Deckenisolation		32		
SR406 0-002	SCHRAUBEN 4.0x60 Sauna- Trägleiste für Saunabänke		19		
SR5 0100	SCHRAUBEN 5.0x100 Fundamenthölzer		72		
SR5 070	SCHRAUBEN 5.0x70 Blendenbefestigung		40		
SR507 0-001	SCHRAUBEN 5.0x70 Sauna- Stützpfosten für Saunabänke		10		
SR509 0-001	SCHRAUBEN 5.0x90 Sauna- Rücklehne 2		12		
SR6 0140	SCHRAUBEN 6.0x140 Blendenstützen		12		
SR50 90-01	5.0x90 Door frames LR - Türrahmen LR - Ukselengid		8		
SS023	Schloßschrauben M8x70 Mutter M8 U-Scheibe Ø25 - Befestigung für Saunabänke		2		
SA2 5-1	SAUNA - Dichtungsband für Deckenisolationselemente		✓		8,0 lfdm
KL1	Gewindestange M8		4		2000
KL2	Gewindestange M8		2		583

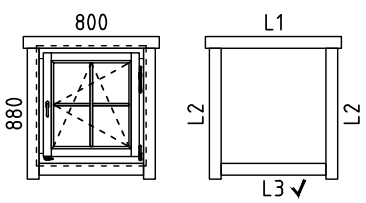
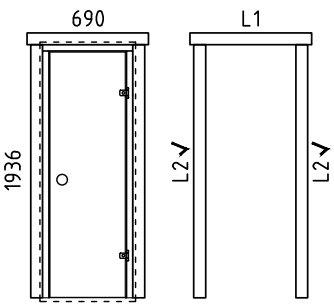
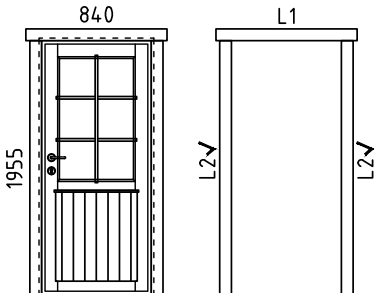
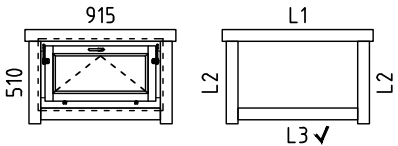

Pos		Stck	Profil (mm)	Länge (mm)
KL3	Gewindestange M8 	2		460
KV M UT M8	Mutter M8 	8		
KV S EIB M8X25	U-Scheibe M8 Ø25 	8		
KV MU TJ M8	Befestigungsmutter M8 	4		
	FENSTER <u>Q4</u> <span style="float:right">W4-S70P-04C-08000880</span>	2		
	 <p>A58-2/W116-PC</p> <p>L1 18x90 L=1040mm 2x                  L2 18x90 L=1000mm 4x                  L3 18x90 L=800mm 2x ✓</p>			
	TÜR <u>Q0</u> <span style="float:right">D0-L70R-0XT-06901936</span>	1		
	 <p>LR/D930-RT</p> <p>L1 18x90 L=930mm 2x                  L2 18x90 L=1935mm 4x ✓</p> <p>DIN rechts</p>			
	TÜR <u>Q4</u> <span style="float:right">D4-S70R-56C-08401955</span>	1		
	 <p>U1-SH (196)/D101-RC</p> <p>L1 18x90 L=1080mm 2x                  L2 18x90 L=1955mm 4x ✓</p> <p>DIN rechts</p>			
	FENSTER <u>Q4</u> <span style="float:right">W4-S70K-0XT-09150510</span>	1		
	 <p>A58-15K/W106-KT</p> <p>L1 18x90 L=1155mm 2x                  L2 18x90 L=630mm 4x                  L3 18x90 L=915mm 2x ✓</p>			
	✓/- bitte selber anpassen (falls nötig)!			

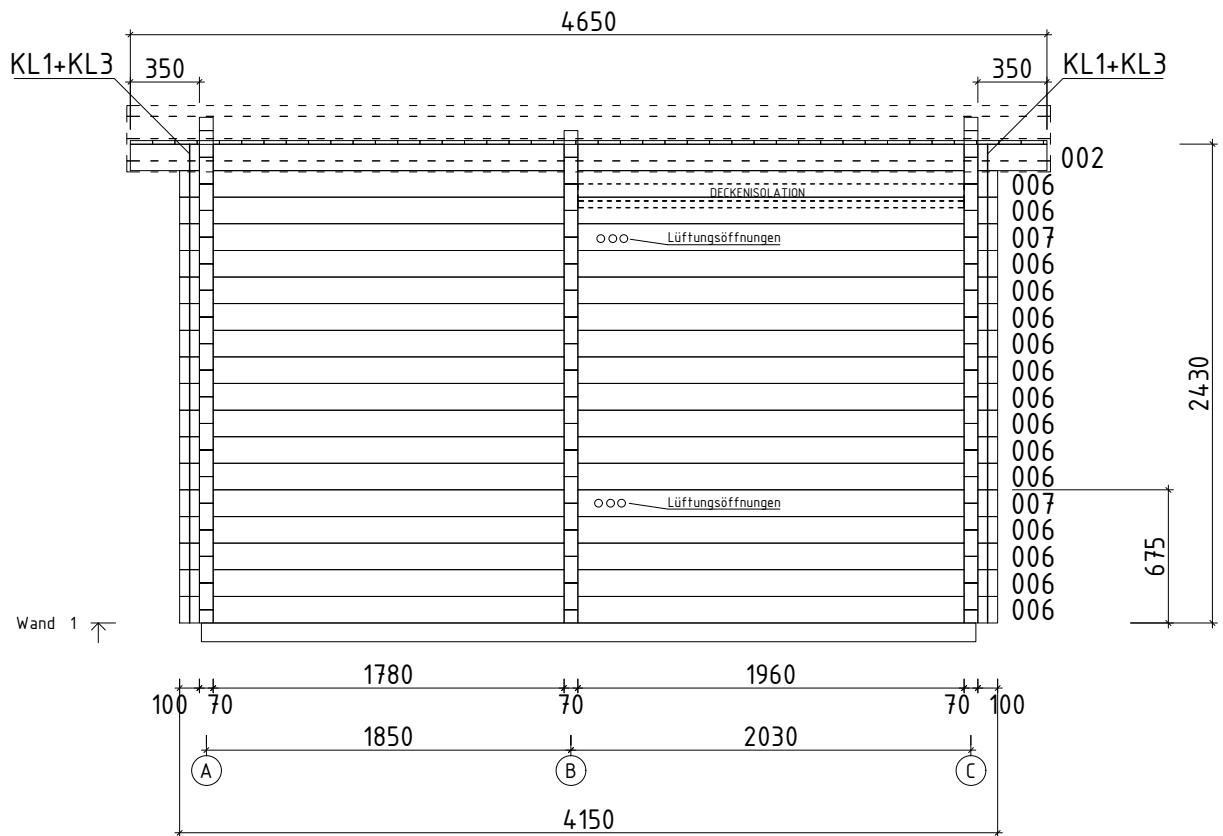

Die Bohlen mit Lüftungsöffnungen können je nach Bedarf höher oder niedriger eingesetzt werden. Bitte achten Sie darauf dass die Lüftungsöffnungen von innen nicht mit der Saunabank bedeckt werden!

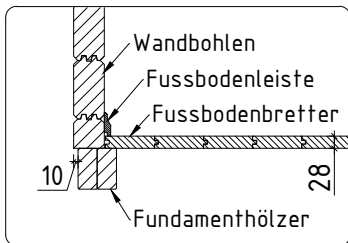
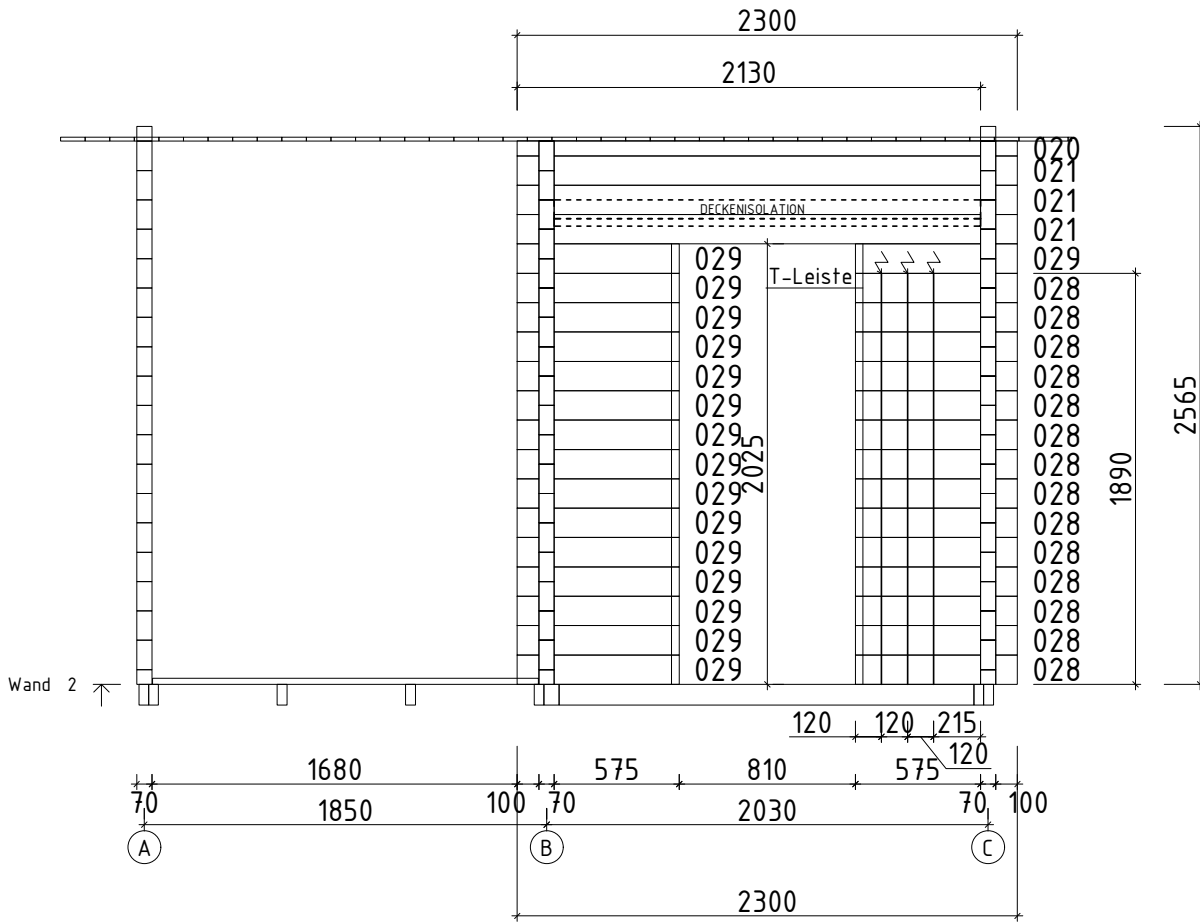

↖ -Bohrung für elektrische Kabel

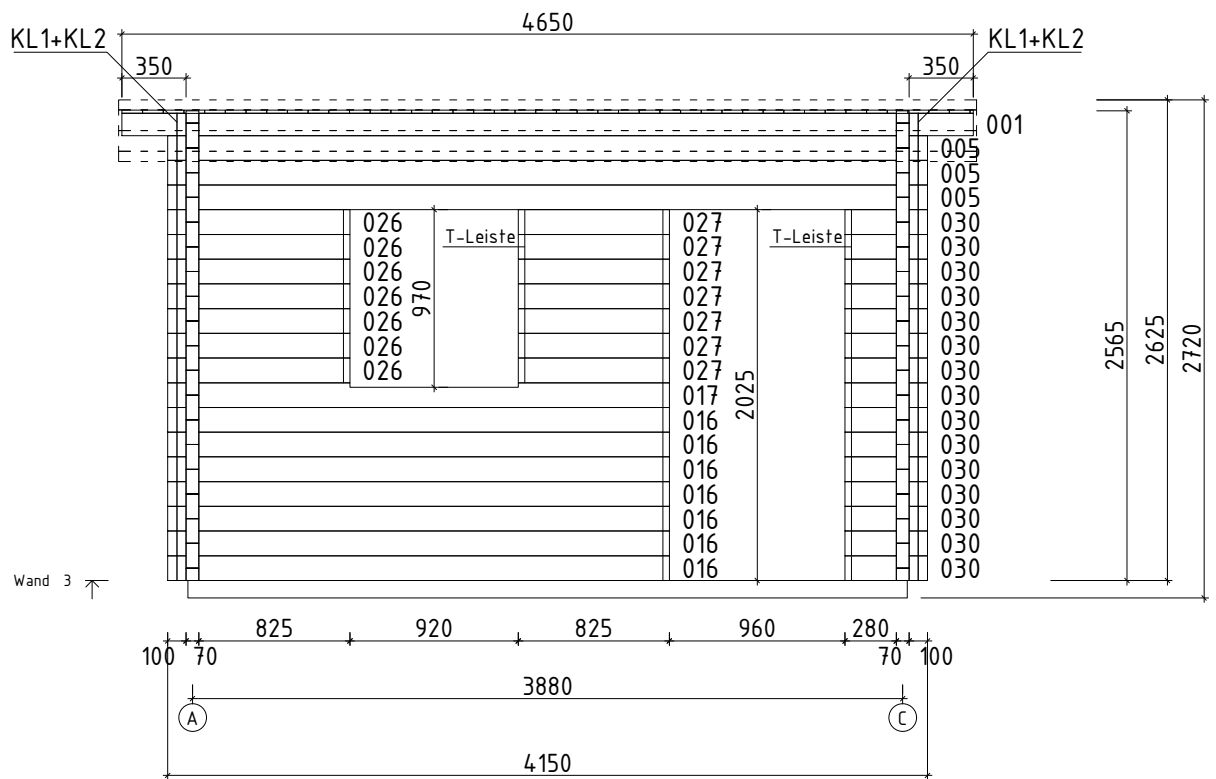

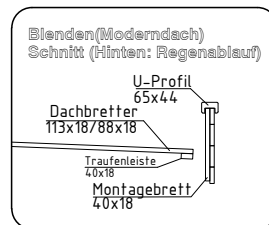
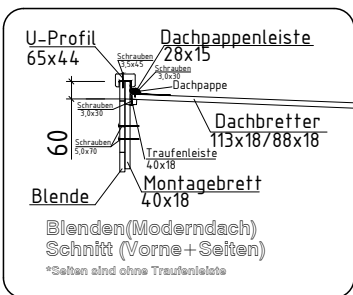
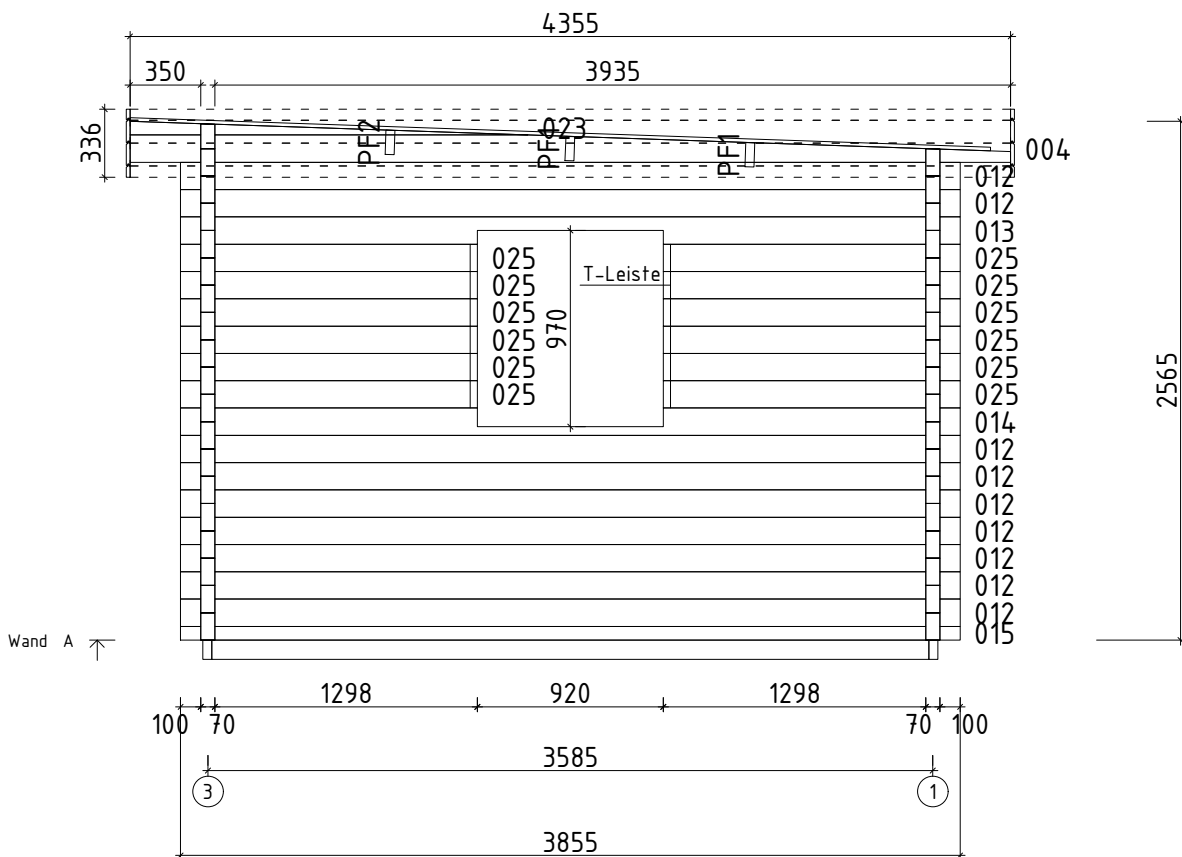

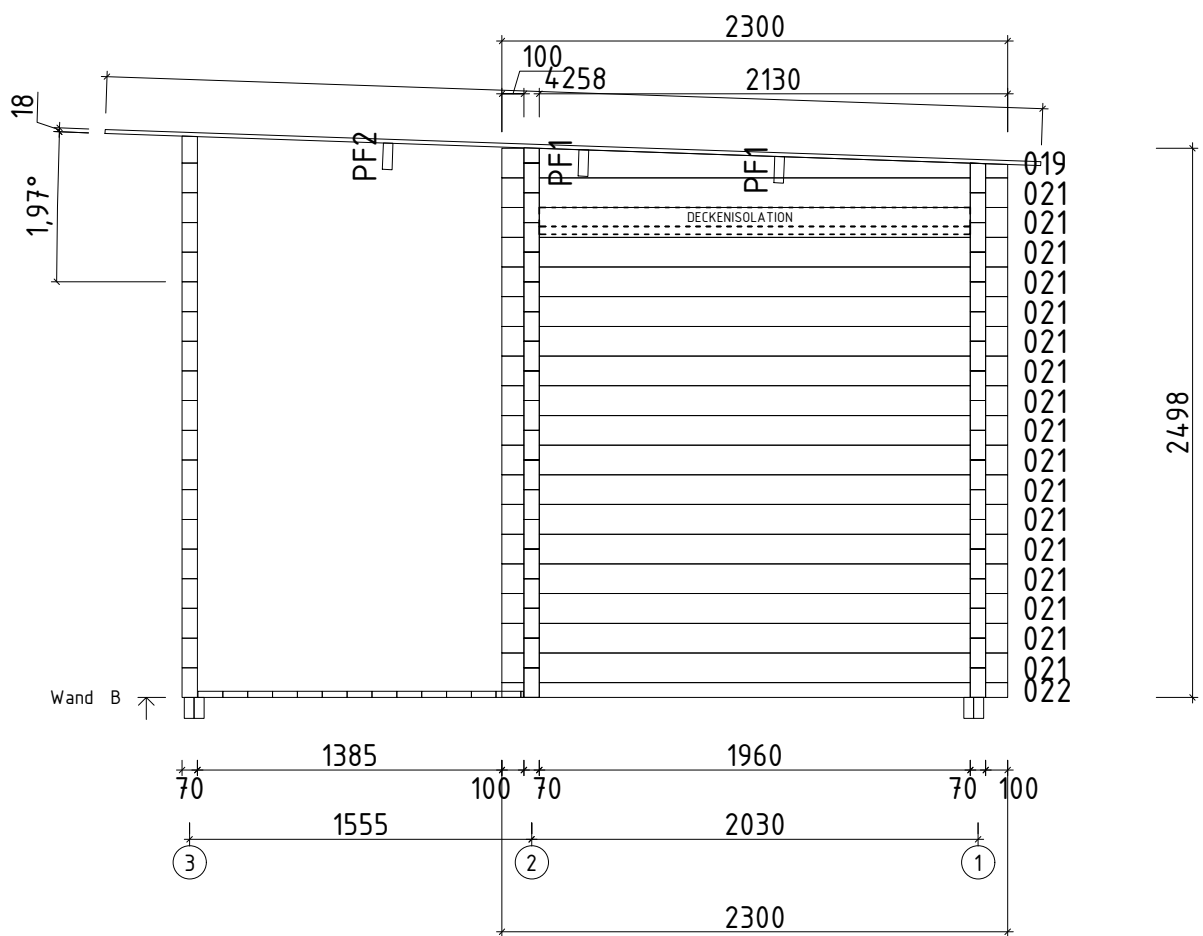

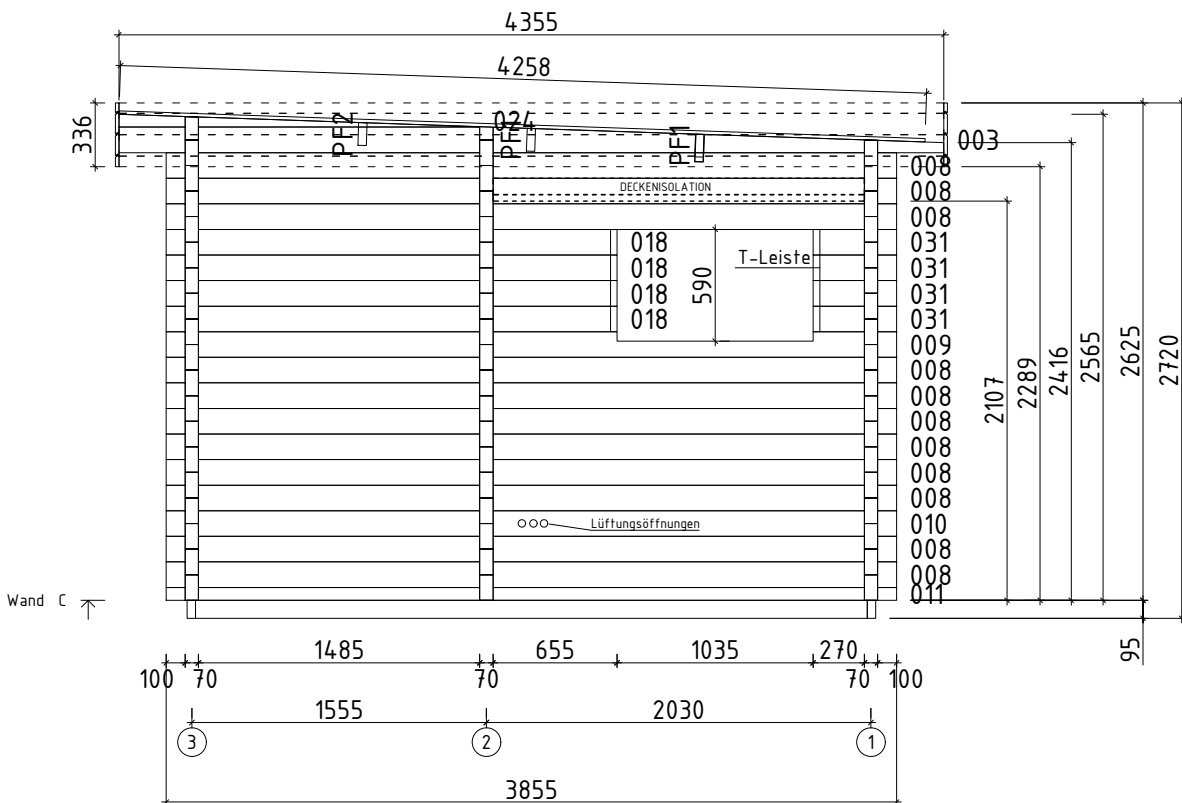

Die Bohlen mit Lüftungsöffnungen können je nach Bedarf höher oder niedriger eingesetzt werden. Bitte achten Sie darauf dass die Lüftungsöffnungen von innen nicht mit der Saunabank bedeckt werden!

## Montageanleitung für T-leisten / Installing the door and window supports / Tenderliistu paigaldusjuhend.

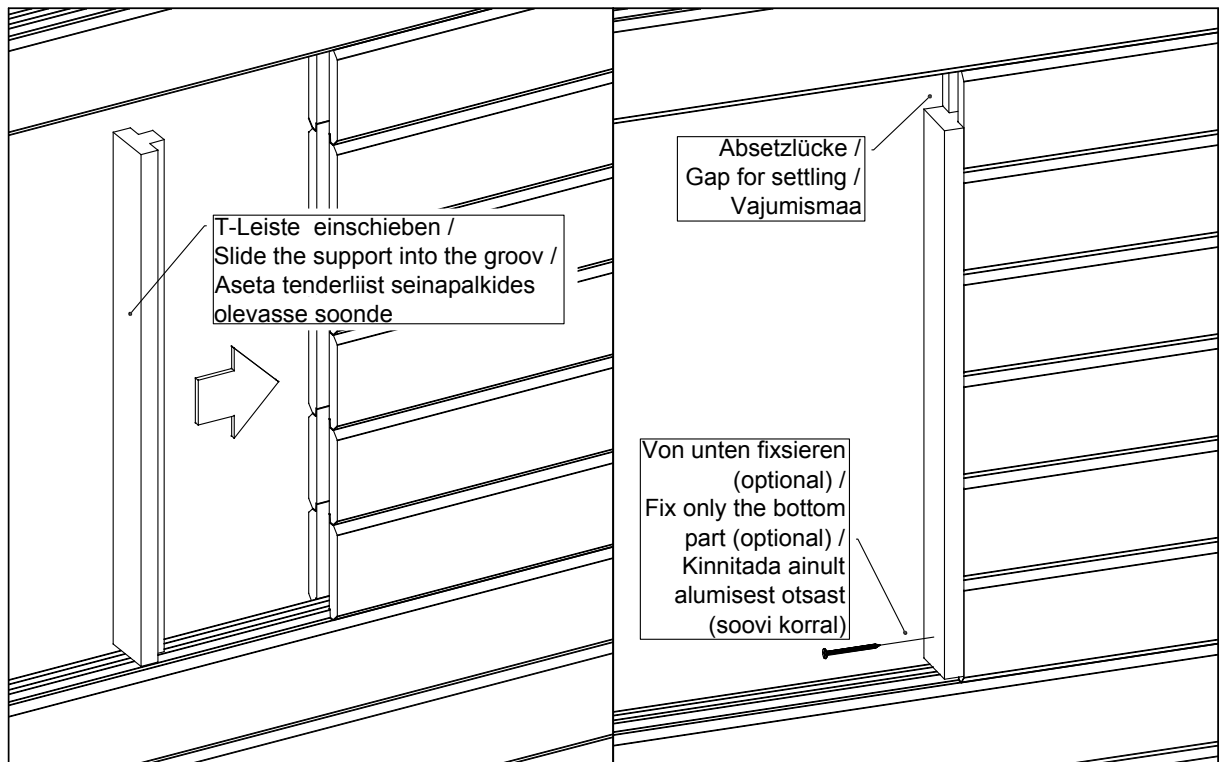



Aken Q4-Q6 - paigaldusjuhised  
 Window Q4-Q6 - assembly instructions  
 Fenster Q4-Q6 - Montageanleitung

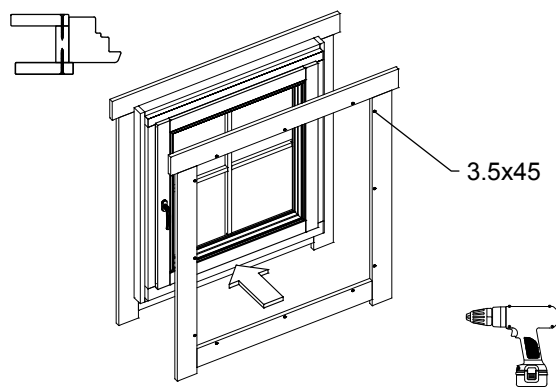
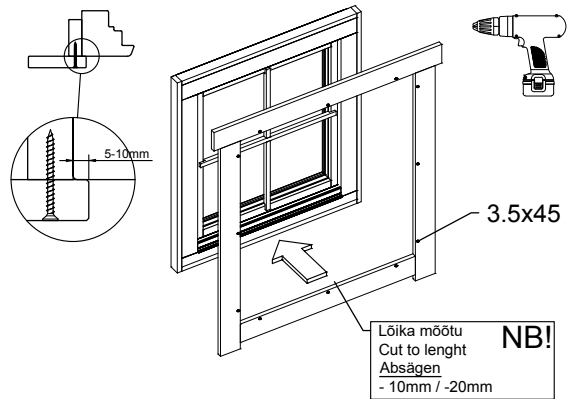
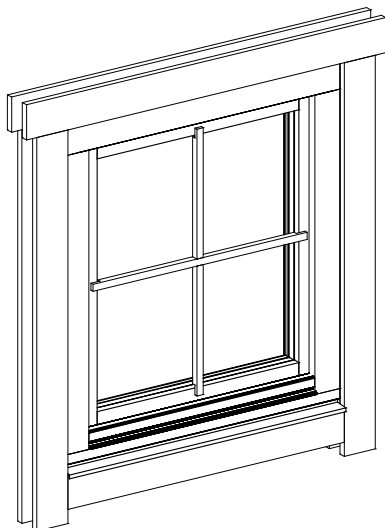

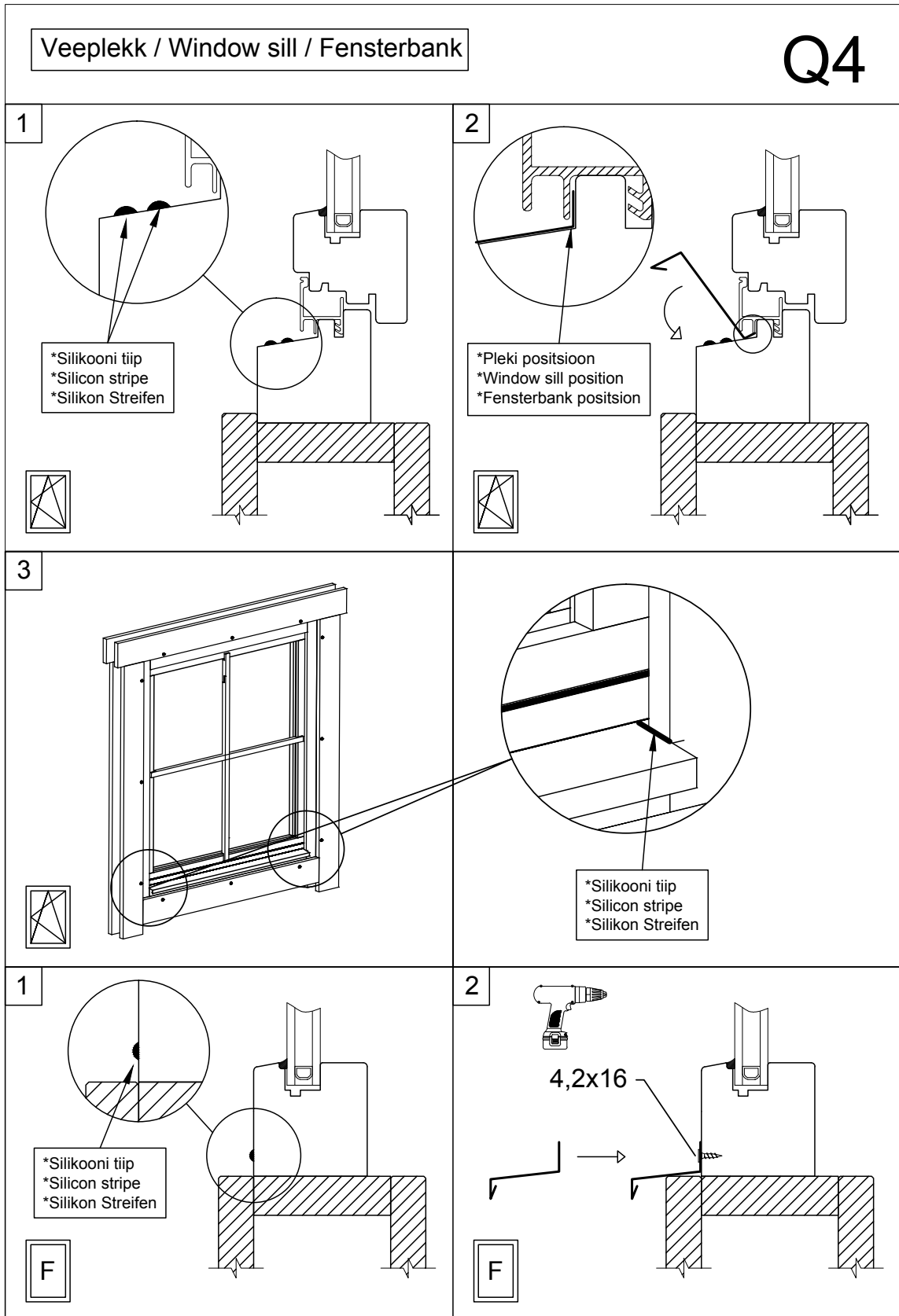

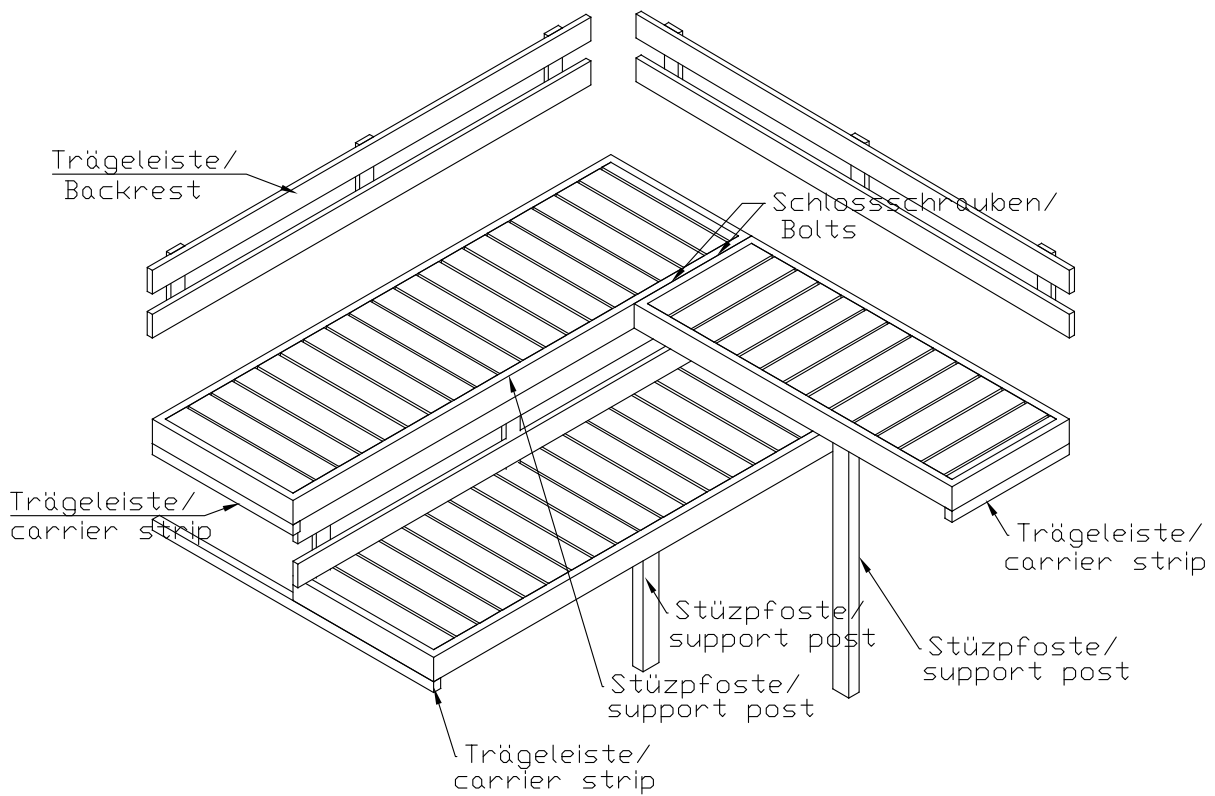

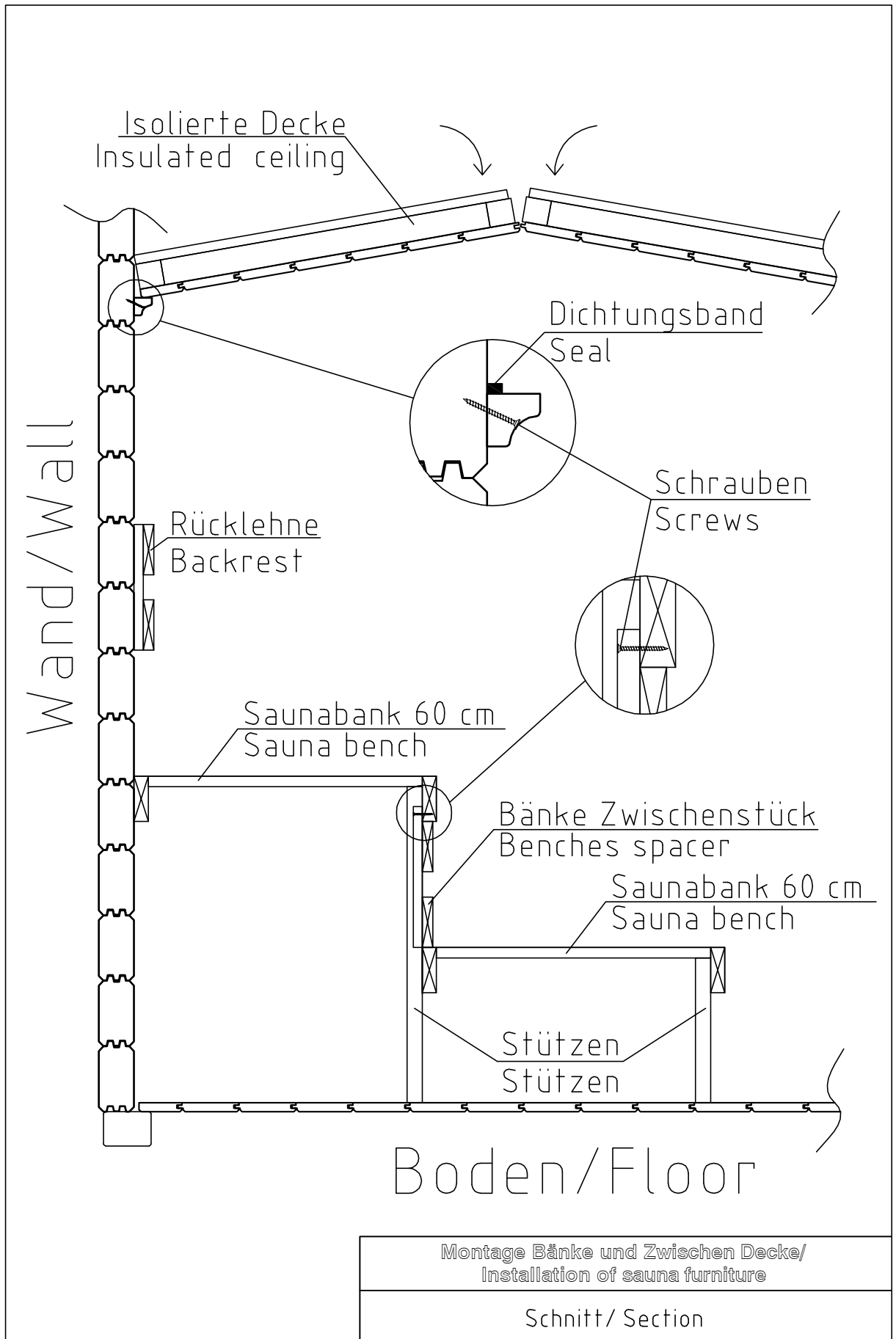

D930-RT

Installation instructions / Aufbauanleitung / Paigaldusjuhend

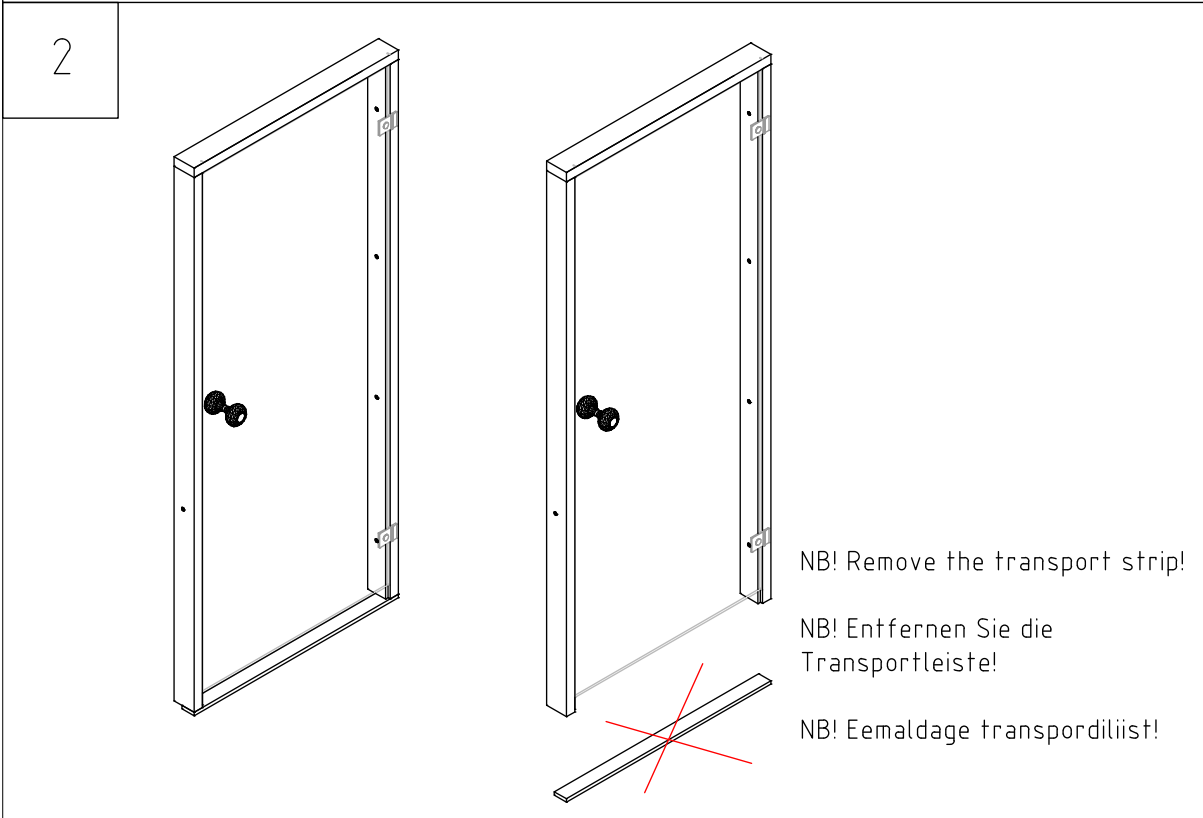
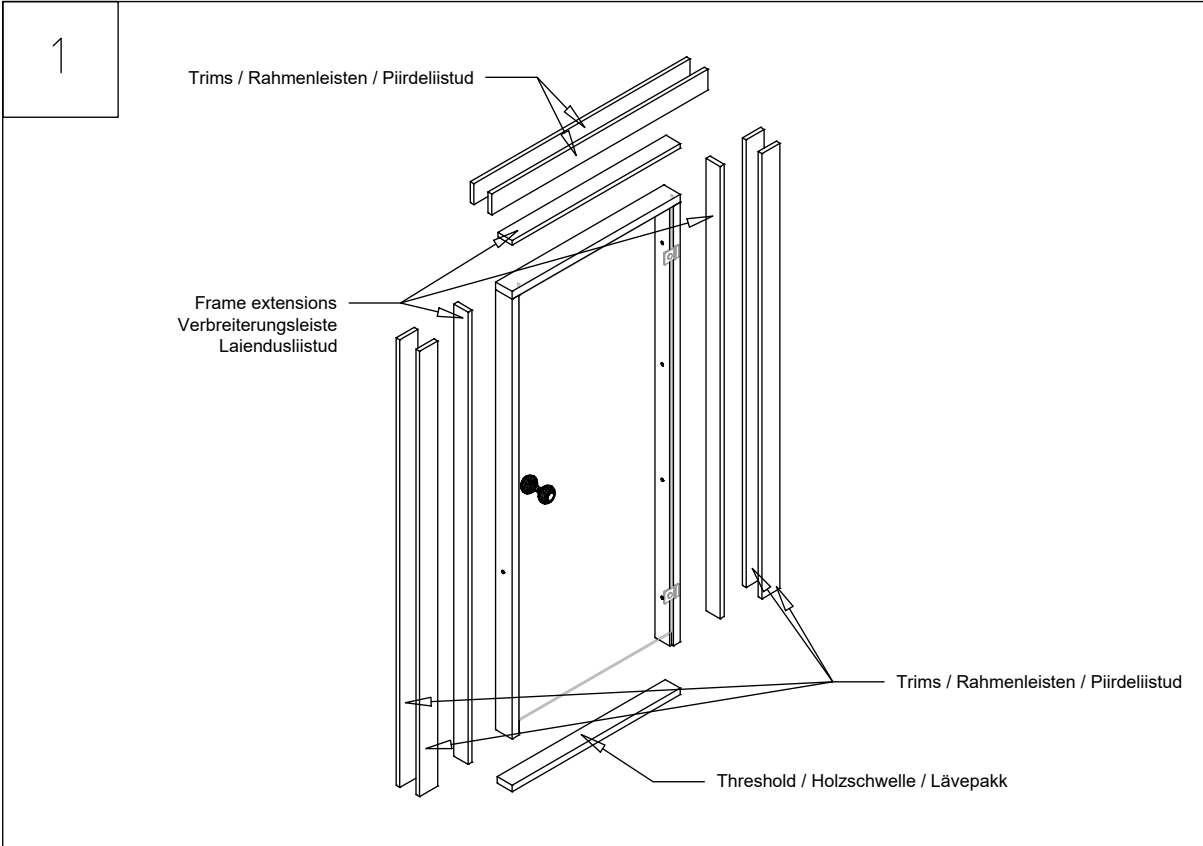

D930-RT

Installation instructions / Aufbauanleitung / Paigaldusjuhend

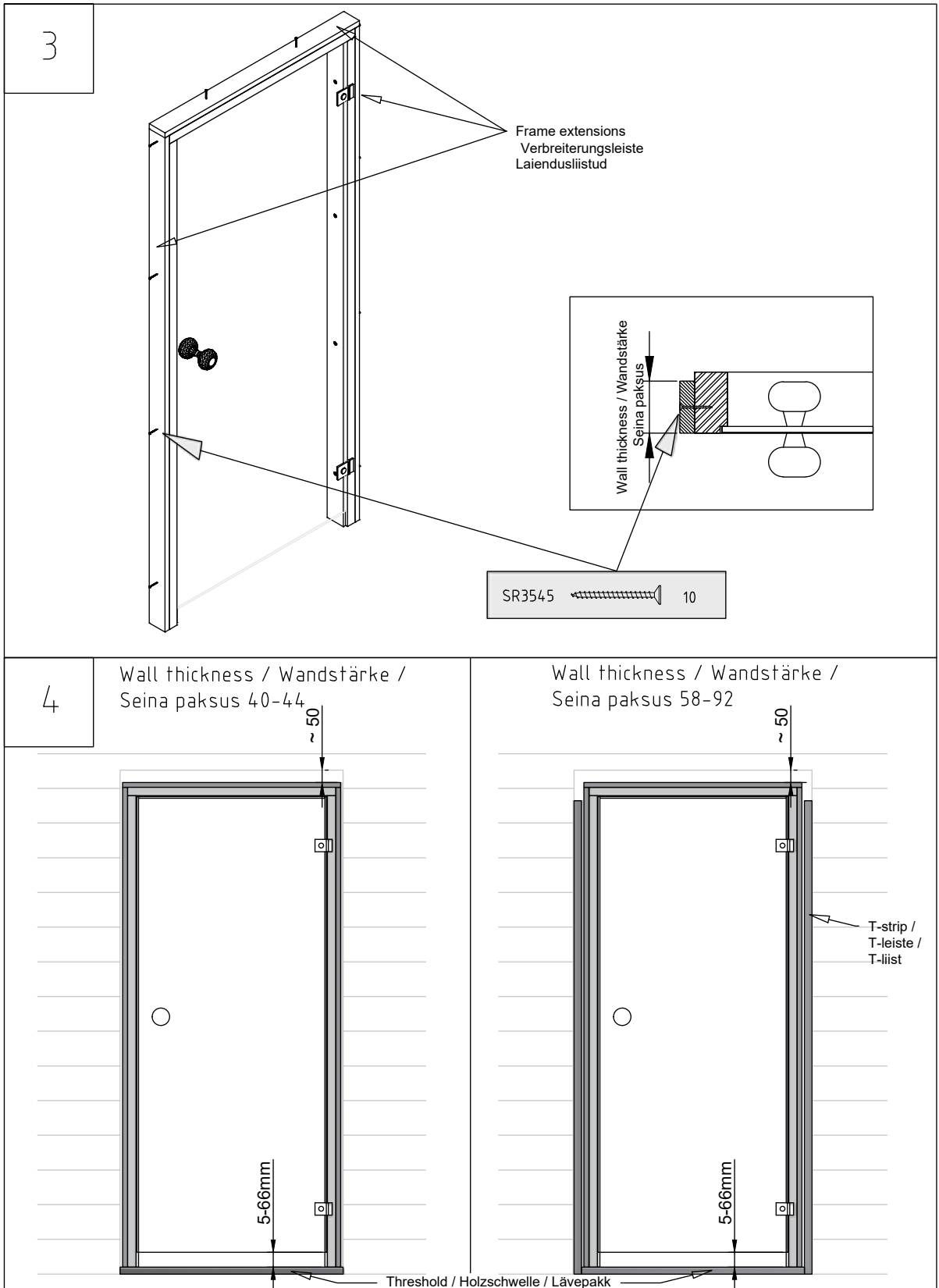

D930-RT

Installation instructions / Aufbauanleitung / Paigaldusjuhend

5

Wall thickness / Wandstärke / Seinapaksus 40-44

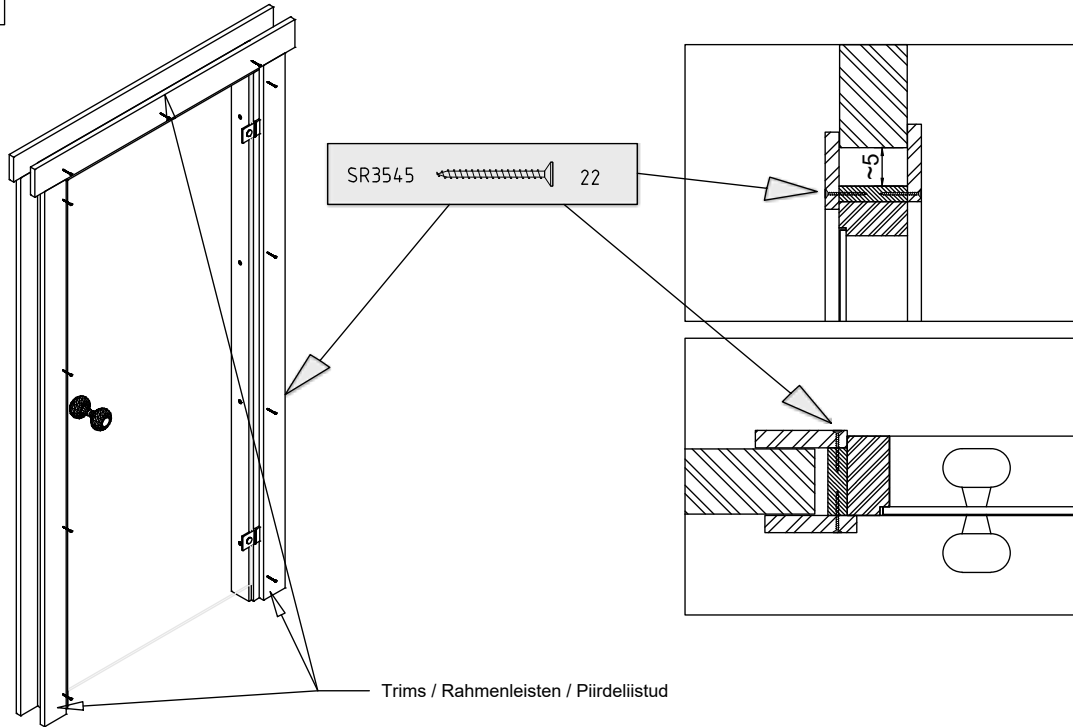

5

Wall thickness / Wandstärke / Seinapaksus 58-92

