

Technische Daten: Art.-Nr: 700 210

Wandaußenmaß: 150 x 360 cm



Abbildung: Art.-Nr: 700 200

Kontrolliert durch:

Achtung: Alle angegebenen Maße sind ca.-Maße!





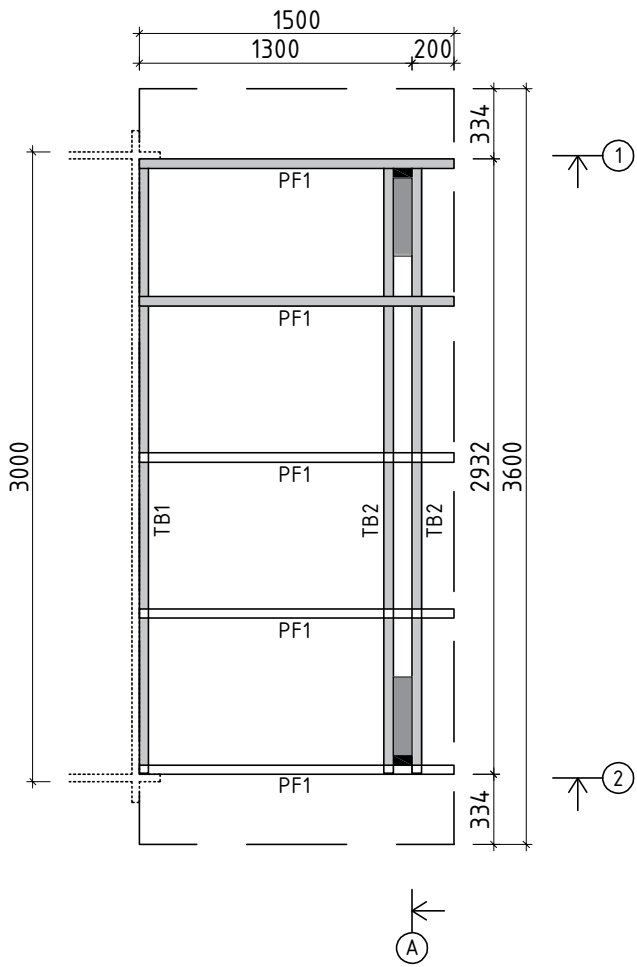
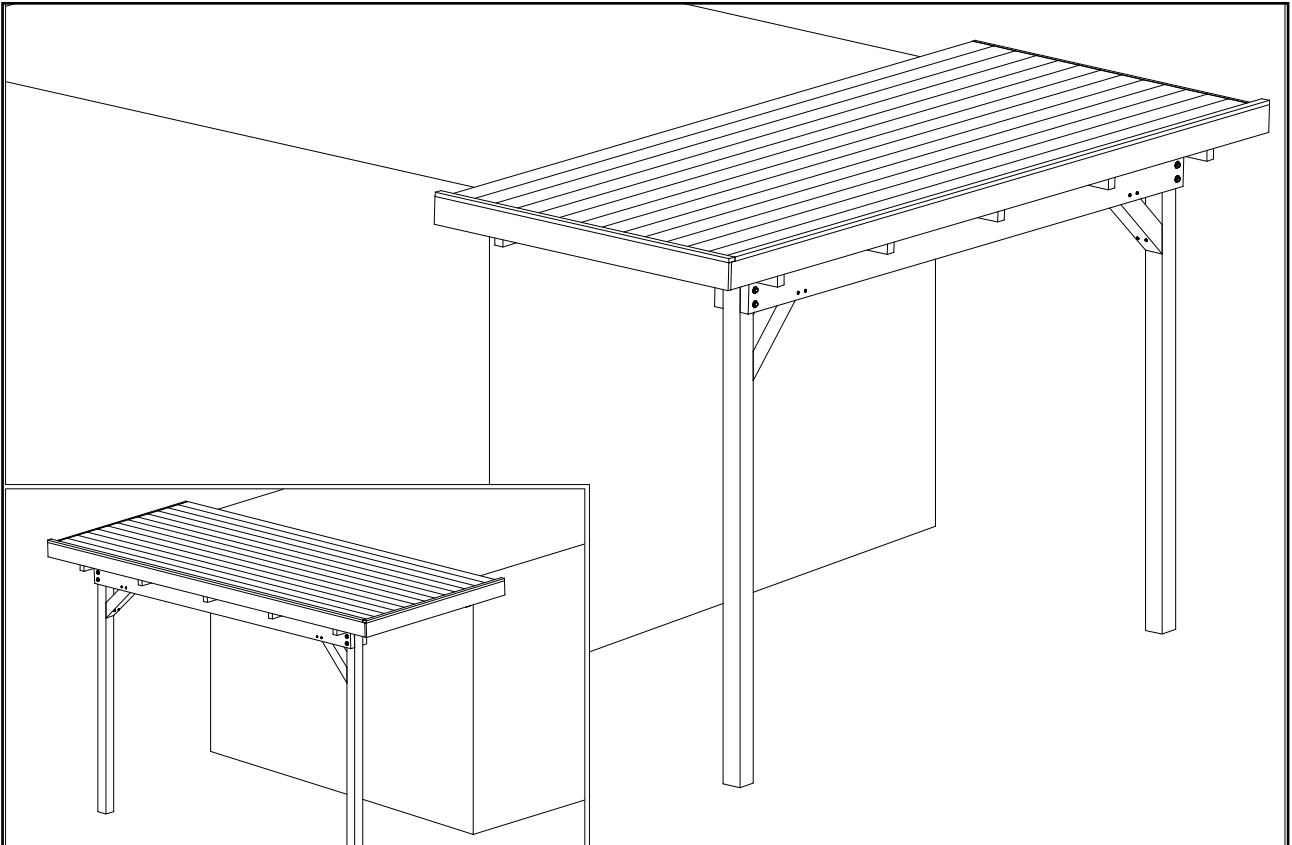





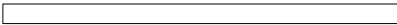
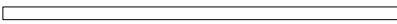

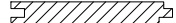
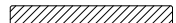

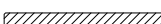

3D-Darstellung und Grundriss

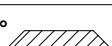
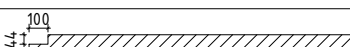
Art.-Nr: 700 210

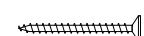
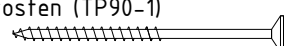
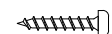

Teileliste 1

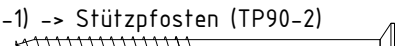
Art.-Nr: 700 210

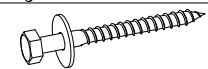
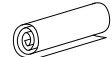
Pos		Stck	Profil (mm)	Länge (mm)
TB2	TRÄGEBALKEN 	2	44x145	2930
TB1	TRÄGEBALKEN 	1	44x94	2930
PF1	PFETTEN 	5	44x145	1500
	DACHBRETTER 	14+1	113x18	3604
G02-1	GIEBELBRETTER 18x120 	1	18x120	3624
G05-1	GIEBELDECKLEISTEN 18x40 	1	18x40	3624
T02-1	TRAUFBRETTER 18x120  ✓	1	18x120	1520
T01-1	TRAUFBRETTER 18x90  ✓	1	18x90	1520
T04-1	TRAUFENDECKLEISTEN 18x40  ✓	1	18x40	1520
T06-1	TRAUFENLEISTEN 18x40  ✓	2	18x40	1520
TP90-1	STÜTZPFOSTEN 90x90  45° 45°	2	90x90	550
TP90-2	STÜTZPFOSTEN 90x90  100 44 ✓	2	90x90	2310
W01	Winkel 40x40x40 	6		
NG01	DACHPAPPNÄGEL 2.8x15 	120		
NG04	NÄGEL 2.5x50 Dachbretter 	140		
SR32	SCHRAUBEN 3.0x30 Giebeldeckleisten Traufenleisten, Traufendeckleisten 	16		
SR37	SCHRAUBEN 3.5x45 Giebelbretter, Traufenbretter 	13		
SR57	SCHRAUBEN 5.0x100 Trägebalken (TB2) -> Stützpfeosten (TP90-1) 	8		
SR51	SCHRAUBEN 5.0x30ÜP Winkel (W01) 	48		
SR55	SCHRAUBEN 5.0x70 Stützpfeosten (TP90-2) -> Pfetten (PF1) 	4		
SR61	SCHRAUBEN 6.0x140 Stützpfeosten (TP90-1) -> Stützpfeosten (TP90-2) 	4		
SS32	Schloßschrauben M8x100 Mutter M8 U-Scheibe Ø25 	11	M8	
SS56	Sechskant Holzschrauben M10x100 U-Scheibe M10 Ø30 	8	M10	
KP-1	DACHPAPPE  ✓		1,8m-4st.	8,0 lfm
	✓ - bitte selber anpassen (falls nötig)!			

Wandplan 1 und 2

Art.-Nr: 700 210

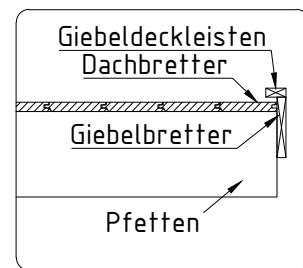
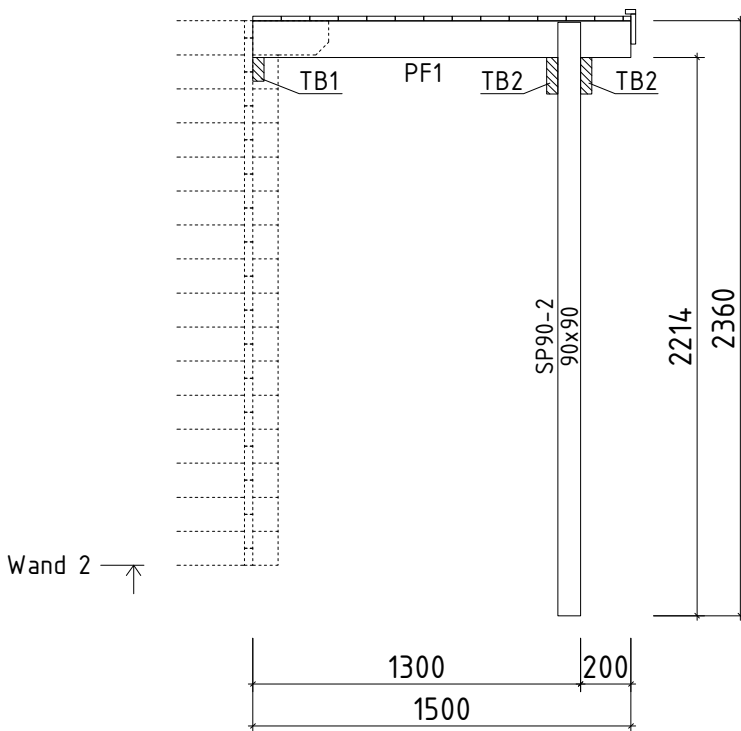
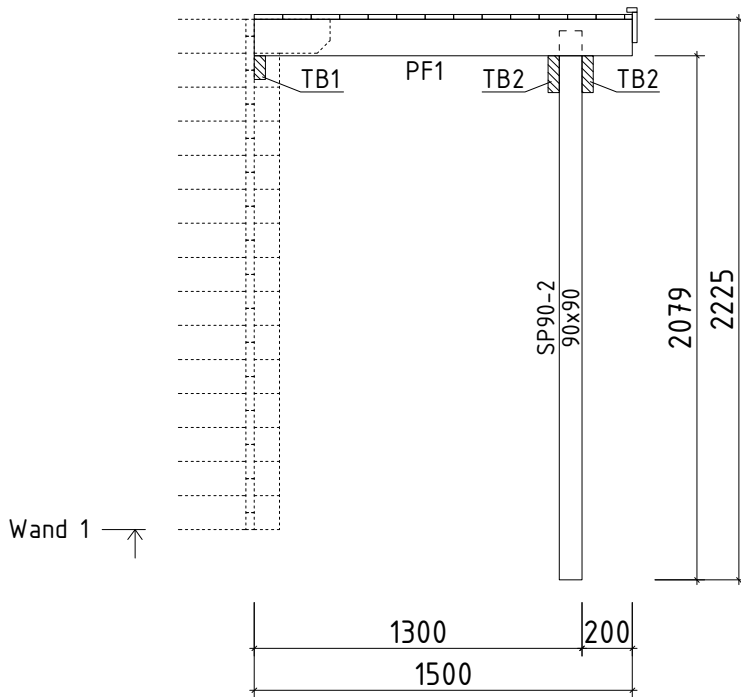

Wandplan A

Art.-Nr: 700 210

