

# Technische Daten

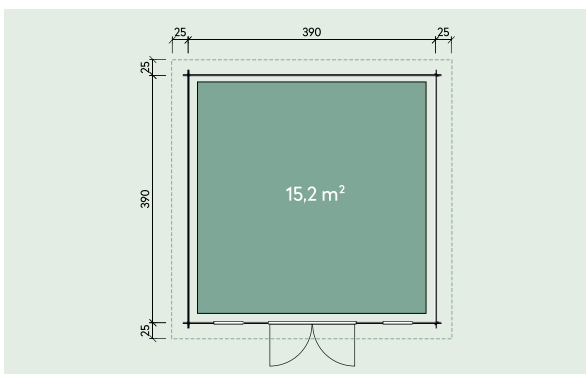

## Artikelnummer:

871 620





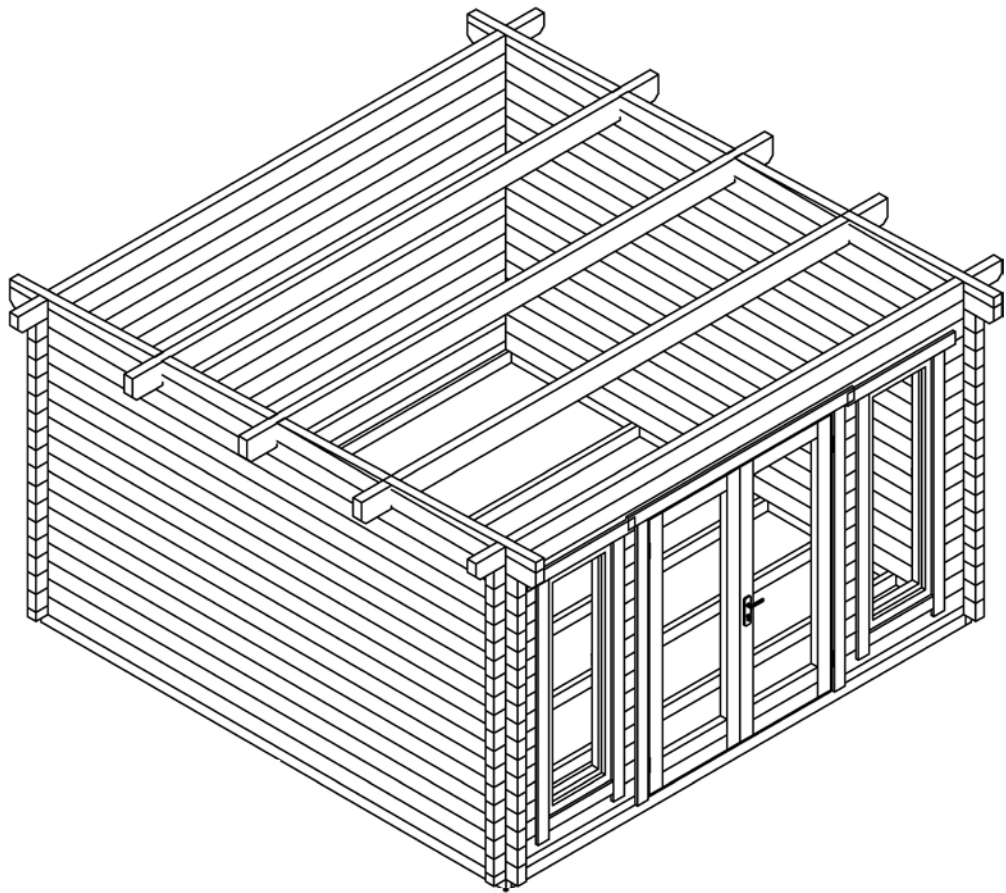

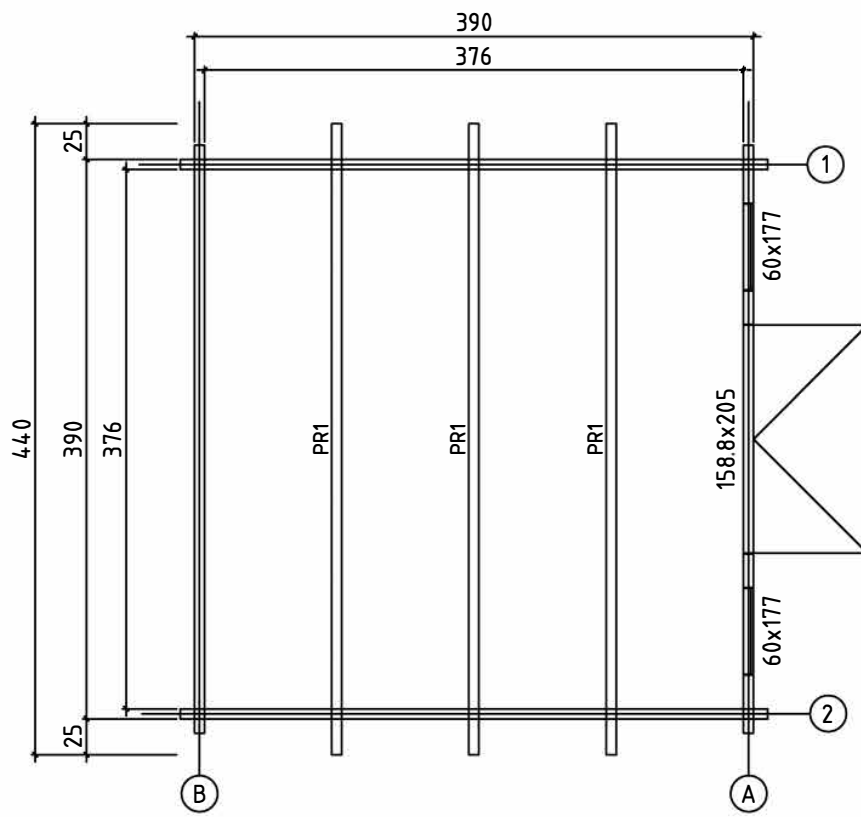



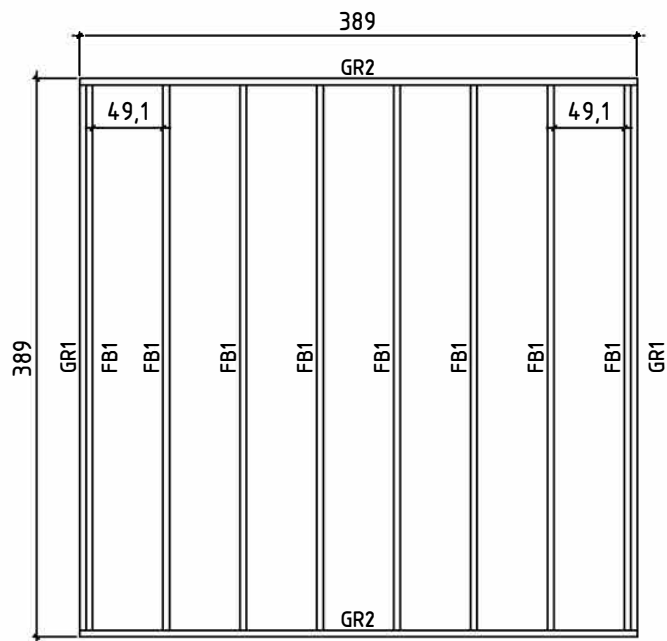

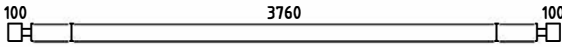
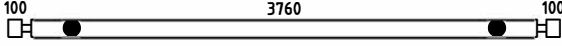
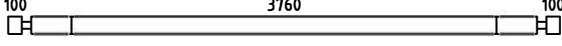
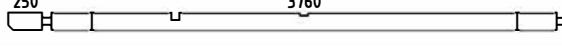



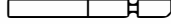

**Kontrolliert durch:**



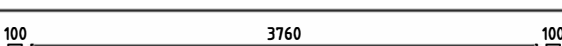
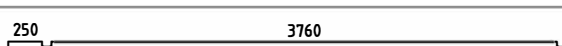
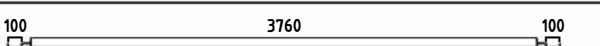







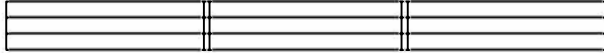
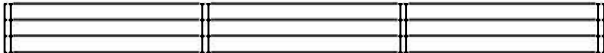







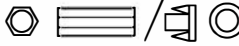



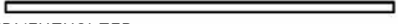





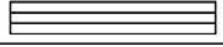

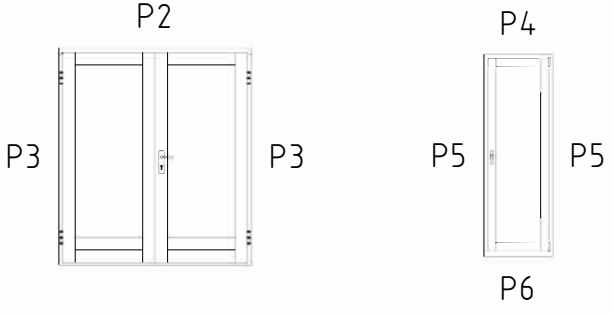

**Wir empfehlen als Fundament für Ihr Gartenhaus eine vollflächig festgegründete, gepflasterte oder betonierte Fläche. Wahlweise ist auch ein Punkt- oder Streifenfundament möglich.**



Pos		Quantity	Profil (mm)	Lenght (mm)
001		2	70x130	4100
002		2	70x130	4100
003		28	70x130	4100
004		2	70x130	4250
005		2	70x95	1213
006		2	70x128	898
007		2	70x130	898
008		2	70x130	1213
009		2	70x73	2165
010		2	70x65	1251
011		2	70x130	1251
012		2	70x130	1251
013		26	70x130	406
014		26	70x130	235
015		1	70x130	4100
016		17	70x130	4100
017		2	70x130	4400
018		1	70x65	4100
GR2		2	45x90	3890
GR1		2	45x90	3800
FB1		8	45x90	3800
PR1		3	70x170	4400
	WINDOW 600x1770	2		
	DOOR 1588x2050	1		

Pos		Quantity	Profil (mm)	Lenght (mm)
	<p>PARAPET R1 - 2 pcs.</p>  <p>PARAPET R2 - 2 pcs.</p> 			
1	<p>Screws/Schrauben/Vis 5x100 mm- For fixing first row of wall logs /Fixierung des ersten Bohlenkranzes/Pour fixer les lamesde plancher</p> 	6		
2	<p>Nails/Nägél/Clous 2.5x50 - For fixing floorboards/ Befestigung Fussbodenbretter/Pour fixer les lames de plancher</p> 	350		
3	<p>Nails/Nägél/Clous 2.5x50 - For fixing roofboards/ Befestigung Dachbretter/Pour fixer les voliges</p> 	300		
4	<p>Nails/Nägél/Clous 2.5x50 - For fixing floor edge trims/ Befestigung Fussleisten/Pour fixer les plinthes du plancher</p> 	30		
5	<p>Screws/Schrauben/Vis 2,5x50 mm- For fixing parapet / Befestigung parapet / Pour fixer les parapet</p> 	180		
6	<p>Screws/Schrauben/Vis 2,5x50 mm- For fixing window and door trims/ Befestigung Fenster und türen/ Pour fixer les croissilons des fenetres et des portes</p> 			
7	<p>Metal storm Brace/Gewindestange/Tige filetee 8 mm</p> 	4		
8	<p>Shim,Nuts/Mutter ,U-Scheibe/Ecrou,Rondelle 8 mm For fixing storm braces/ Pour fixer les anti tempete/ Für Sturmleisten Pour fixer les croissilons des fenetres et des portes</p>  <p>Metal storm Brace/Gewindestange/Tige filetee 8 mm KL1 M8 2,51 m 2 Screws 180 8 pcs. KL2 M8 2,41 m 2 Plastic caps 4 pcs.</p>	4/4		
9	<p>Roofing felt/Dachpappe/Feutre de toiture</p>	10+15		
10	<p>Nails/Nägél/Clous - For fixing roofing felt/ Befestigung Dachpappe/Pour fixer les feutre de toiture</p> 	210		

					Teileliste	
POS	ST.	B	H	L		
FB1	Vt. spetsi					FUNDMENTHOLZER 
F1	14,1m <sup>2</sup>	28		3755		FUSSBODENBRETTER
PR	3	70	170	4400		DACHBALKEN 
RB1	19,4m <sup>2</sup>	20		4403		DACHBRETTER
R1	2	20	360	4440		PARAPET
R2	2	20	360	4445		PARAPET
R3	2	45	45	4400	<input type="checkbox"/>	BEFESTIGUNG DACHBRETTER 
R4	2 2	45	90	250 295	<input type="checkbox"/>	BEFESTIGUNG PARAPET 
DR1 WN1	1 2	1588 600	2050 1770	 <p style="text-align: center;">P2</p> <p style="text-align: center;">P4</p> <p style="text-align: center;">P3                      P3                      P5                      P5</p> <p style="text-align: center;">P6</p> <p style="text-align: center;">Sliding slats 30x30x1600 mm - 4 pcs.</p>		
P1	16m	20	40			Fußbodenleiste
P2	1+1	20	90	1890		Türleiste DR1 
P3	2+2	20	90	2030		Türleiste DR1 
P4	2+2	20	90	900		Fensterleiste WN1 
P5	4+4	20	90	1920		Fensterleiste WN1 
P6	2+2	20	90	540 570		Fensterleiste WN1 