

Technische Daten: Art.-Nr.: 871 749 mit Seitendach 300 cm links

Wandaußenmaß: 360 x 360 cm

Bohlenstärke: 70 mm



Der Fußboden wurde bauseits vom Kunden ergänzt.

Kontrolliert durch:

Achtung: Alle angegebenen Maße sind ca.-Maße!

Grundriss

871 749 mit Seitendach 300 cm links

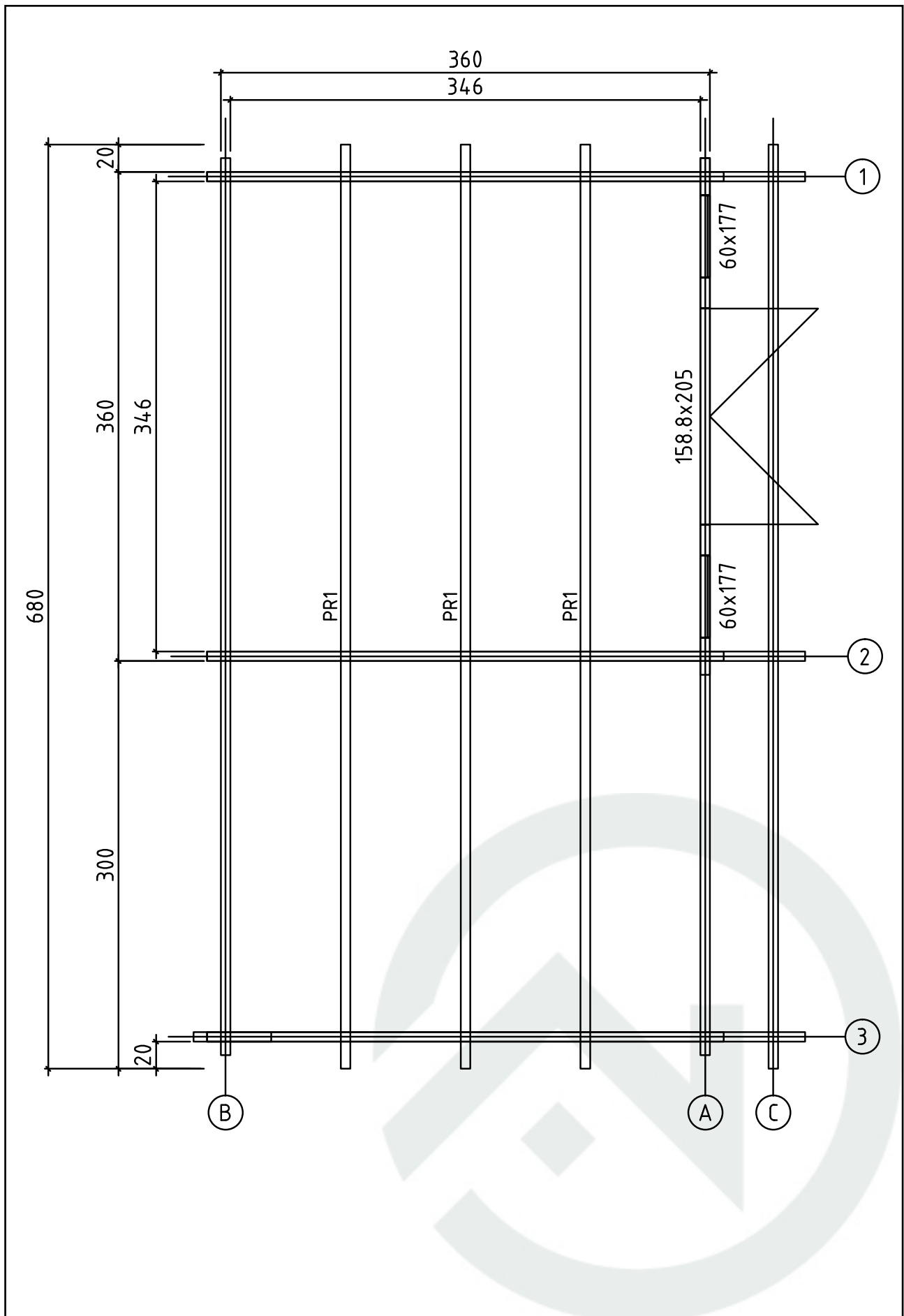

Lagerholzplan und Fundamentplan 871 749 mit Seitendach 300 cm links

Wir empfehlen als Fundament für Ihr Gartenhaus eine vollflächig festgegründete, gepflasterte oder betonierte Fläche.
Wahlweise ist auch ein Punkt- oder Streifenfundament möglich.









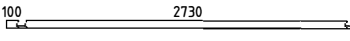
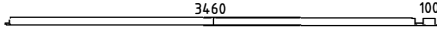
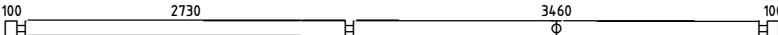
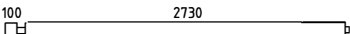
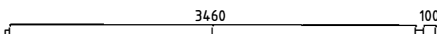

Teilleiste 1

871 749 mit Seitendach 300 cm links

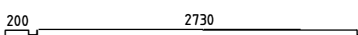
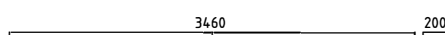
Pos		Quantity	Profil (mm)	Lenght (mm)
001		2	70x130	3800
002		2	70x130	3800
003		26	70x130	3800
004		2	70x130	3900
005		3	70x118	1087
006		3	70x130	823
007		2	70x130	2270
008		3	70x45	693
009		2	70x102	852
010		3	70x130	1588
011		3	70x78	1207
012		1	70x130	470
013		14	70x130	470
014		1	70x130	3900
015		1	70x130	2270
016		1	70x102	852
017		2	70x65	1101
018		2	70x130	1101
019		2	70x130	1101
020		26	70x130	270
021		26	70x130	221
022		1	70x130	3800
023		1	70x130	6800
024		1	70x98	3035
025		1	70x98	3765

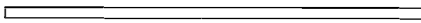
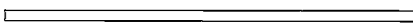



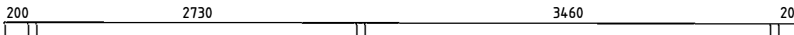









Teileliste 2

871 749 mit Seitendach 300 cm links

Pos		Quantity	Profil (mm)	Lenght (mm)
026		1	70x65	2935
027		1	70x65	3665
028		1	70x130	6600
029		7	70x130	2935
030		7	70x130	3665
031		7	70x130	6600
032		1	70x130	3035
033		1	70x130	3765
034		1	70x130	6800
035	=	1	70x27	60
036	↓	2	70x27	60
GR3	GROUNDFRAME 	2	45x90	3590
GR2	GROUNDFRAME 	7	45x90	3500
GR1	GROUNDFRAME 	1	45x90	2710
GR4	GROUNDFRAME 	2	45x90	360
FB2	FLOORBEAMS 	2	45x90	3500
FB1	FLOORBEAMS 	1	45x90	2710
PR1	Purlins 	3	70x170	6800
70MM A-5	WINDOW 600x1770	2		
Wolff 70 mm Double Door 1H	DOOR 1588x2050	1		

Teileliste 3

871 749 mit Seitendach 300 cm links

1	Screws/Schrauben/Vis 5x100 mm- For fixing first row of wall logs /Fixierung des ersten Bohlenkranzes/Pour fixer les lamesde plancher		6		
2	Nails/Nägel/Clous 2.5x50 - For fixing floorboards/ Befestigung Fussbodenbretter/Pour fixer les lames de plancher		300		
3	Nails/Nägel/Clous 2.5x50 - For fixing roofboards/ Befestigung Dachbretter/Pour fixer les voliges		450		
4	Nails/Nägel/Clous 2.5x50 - For fixing floor edge trims/ Befestigung Fussleisten/Pour fixer les plinthes du plancher		40		
5	Nails/Nägel/Clous 2.5x50 - For fixing roofing felt fillet/ Befestigung giebelabschlussbrett/Pour fixer la latte de finition de la couverture		30		
6	Screws/Schrauben/Vis 2,5x50 mm- For fixing roof side boards and roof edge reinforcement Befestigung Traufenbretter und Traufleisten Pour fixer les planches de rive et le tasseau de refront		175		
7	Screws/Schrauben/Vis 2,5x50 mm- For fixing fascia boards and diamonds/ Befestigung Giebelblende und Raute Pour fixer les planches de rive et le diamant				
8	Screws/Schrauben/Vis 2,5x50 mm- For fixing fwindow and door trims/ Befestigung Fenster und türen/ Pour fixer les croisillons des fenetres et des portes				
9	Metal storm Brace/Gewindestange/Tige filetee 10 mm		3		
10	Shim;Nuts/Mutter ,U-Scheibe/Ecrou;Rondelle 10 mm For fixing storm braces/ Pour fixer les anti tempete/ Für Sturmleisten Pour fixer les croisillons des fenetres et des portes Metal storm Brace/Gewindestange/Tige filetee 10 mm KL1 M10 2,25 m 1 Screws 180 6 pcs. KL2 M10 2,44 m 2 Plastic caps 3 pcs.	    	3/3		

Teileliste 4

871 749 mit Seitendach 300 cm links

POS	ST.	B	H	L	Teileliste
FB1	Vt. spetsi				FUNDMENTHOLZER
F1	12m ²	28		3455	FUSSBODENBRETTER
PR	3	70	170	6800	DACHBALKEN
RB1	30,7m ²	20		4510	DACHBRETTER
R1	4	20	140	3420	<small>Vozta kafise kalenirka</small> Traufenbretter
R2	4	45	65	3400	<small>Vozta kafise kalenirka</small> Traufenbretter
R3	2	20	140	4710	<small>Vozta kafise kalenirka</small> Giebelabschlussleiste
R4	2	20	90	4710	Giebelabschlussleiste
PS1	1	120	120	2050	<input type="checkbox"/> POSTS FOR SIDEROOF 卐 卍
WN06	2	600	1770		<p style="text-align: center;">P3 P2 P2 P4</p>
DR16	1	1588	2050		<p style="text-align: center;">P3 P5 P5</p>
Sliding slats 30x30x1600 mm - 4 pcs.					
P1	15m	20	40		Fußbodenleiste
P2	4+4	20	90	1920	Fensterleiste WN 06
P3	1+1	20	90	3440	Türleiste DR 16, Fensterleiste WN 06
P4	2+2	20	90	540 570	Fensterleiste WN 06
P5	2+2	20	90	2030	Türleiste DR 16

Detailzeichnungen

871 749 mit Seitendach 300 cm links

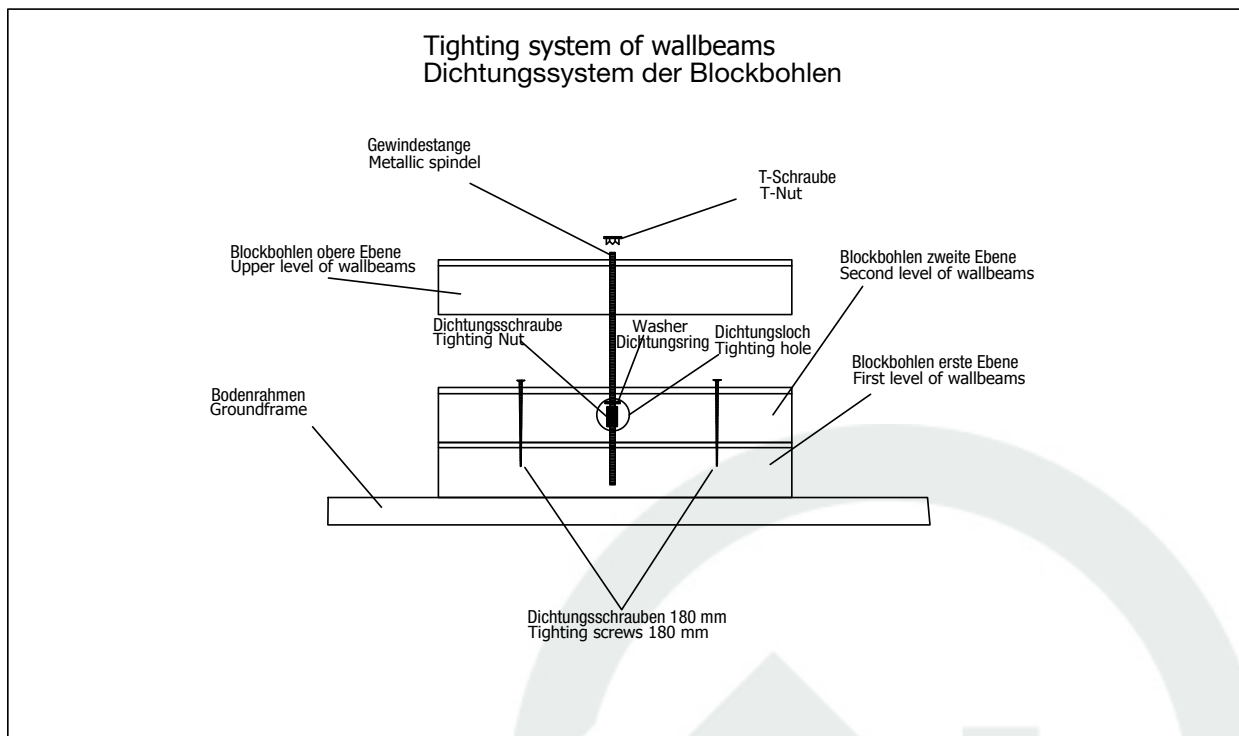
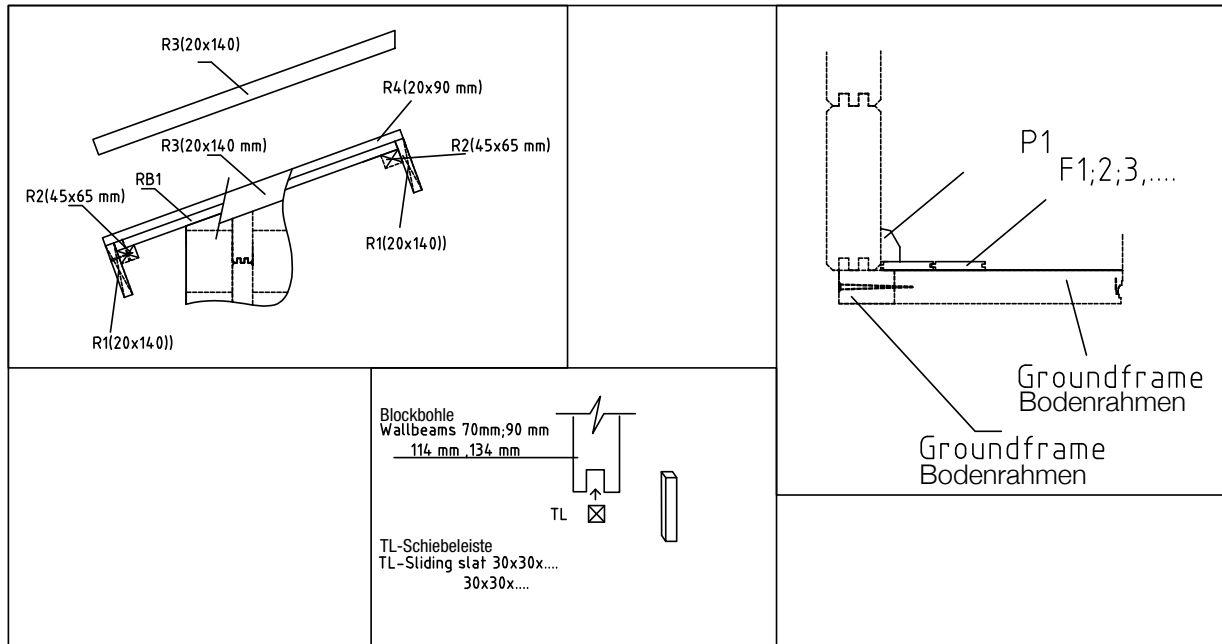

Wandplan 1 und 2

871 749 mit Seitendach 300 cm links

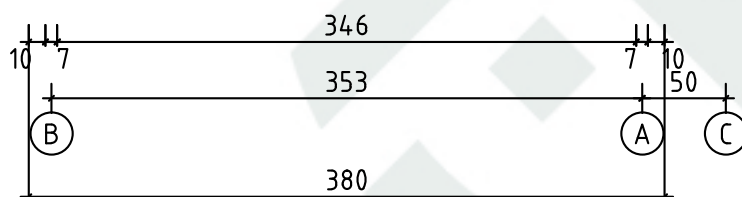
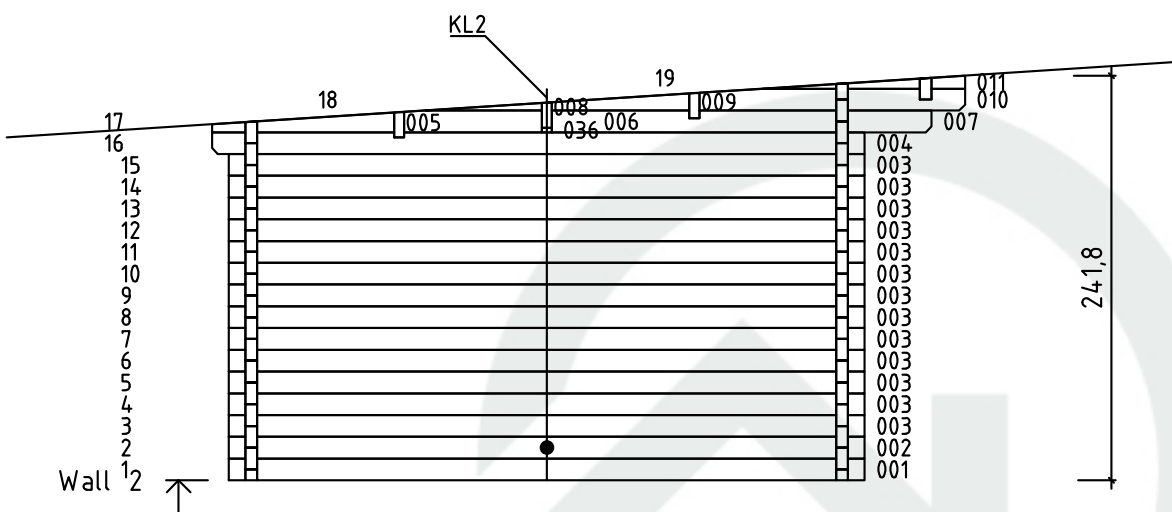
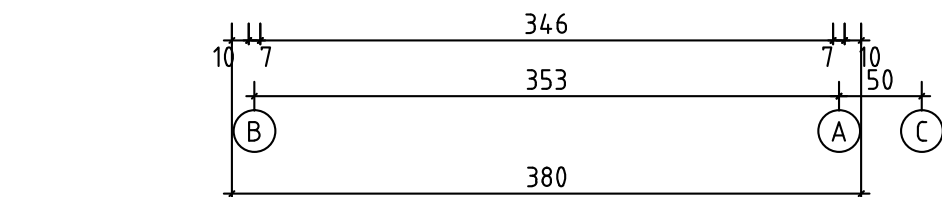
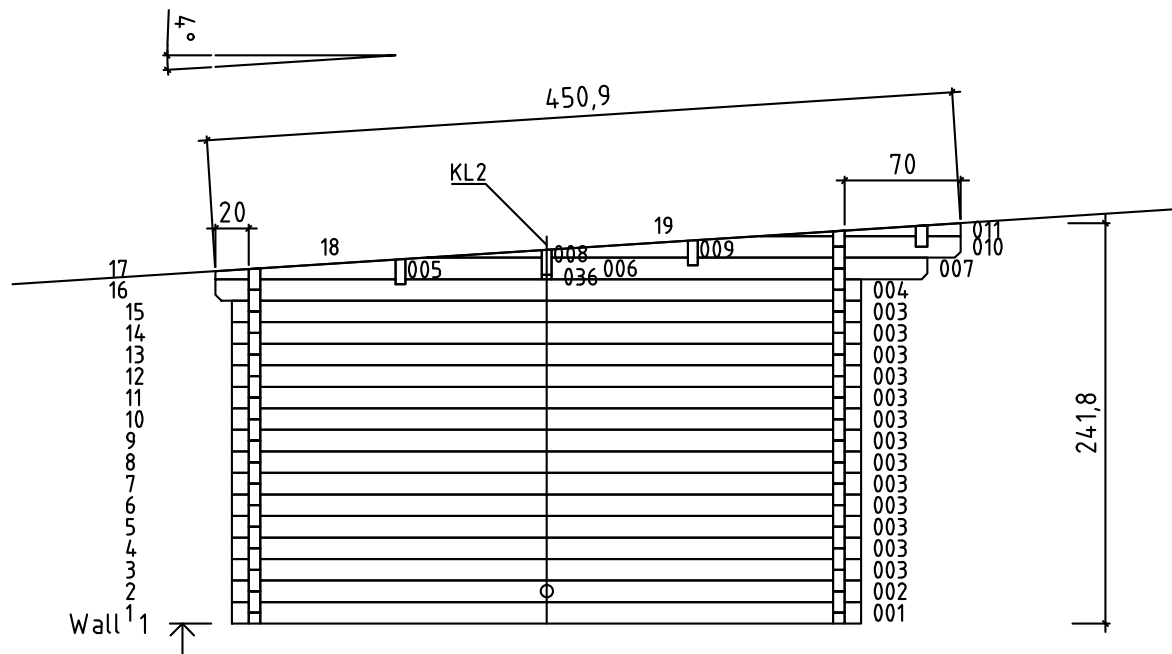

Wandplan 3

871 749 mit Seitendach 300 cm links

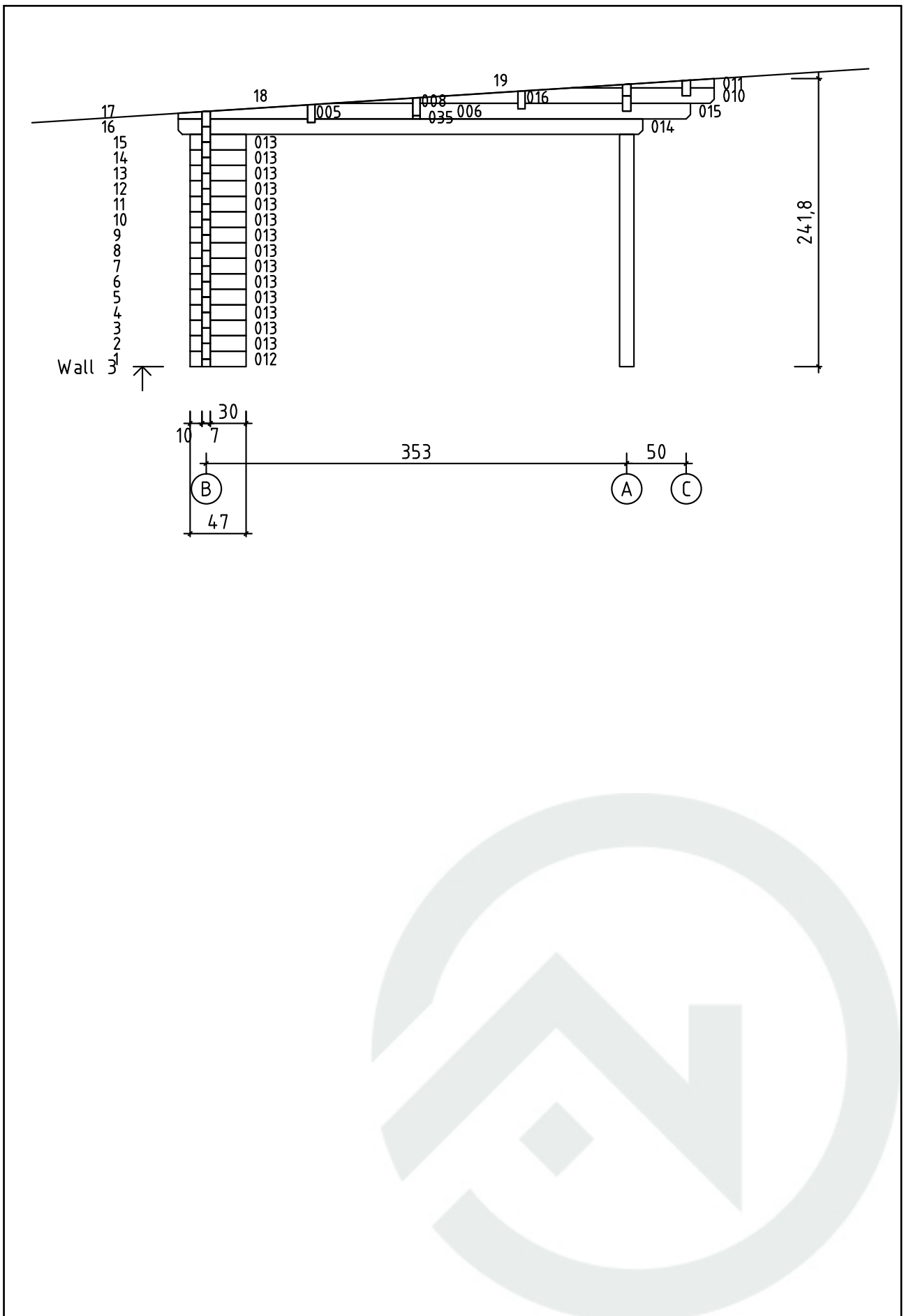

Wandplan A, B und C

871 749 mit Seitendach 300 cm links

