

Technische Daten



Spiegelverkehrte Montage möglich. Durch Kunden farblich behandelt.

Artikelnummer:

231 540

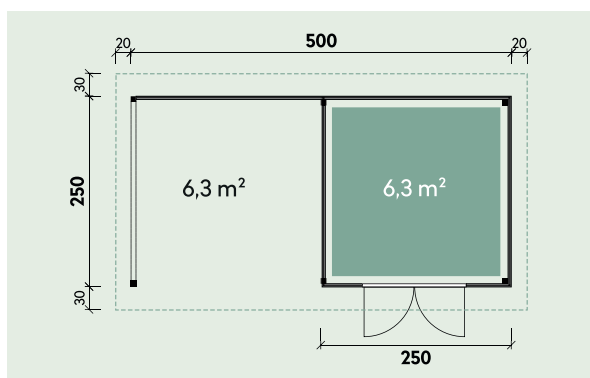

Kontrolliert durch:

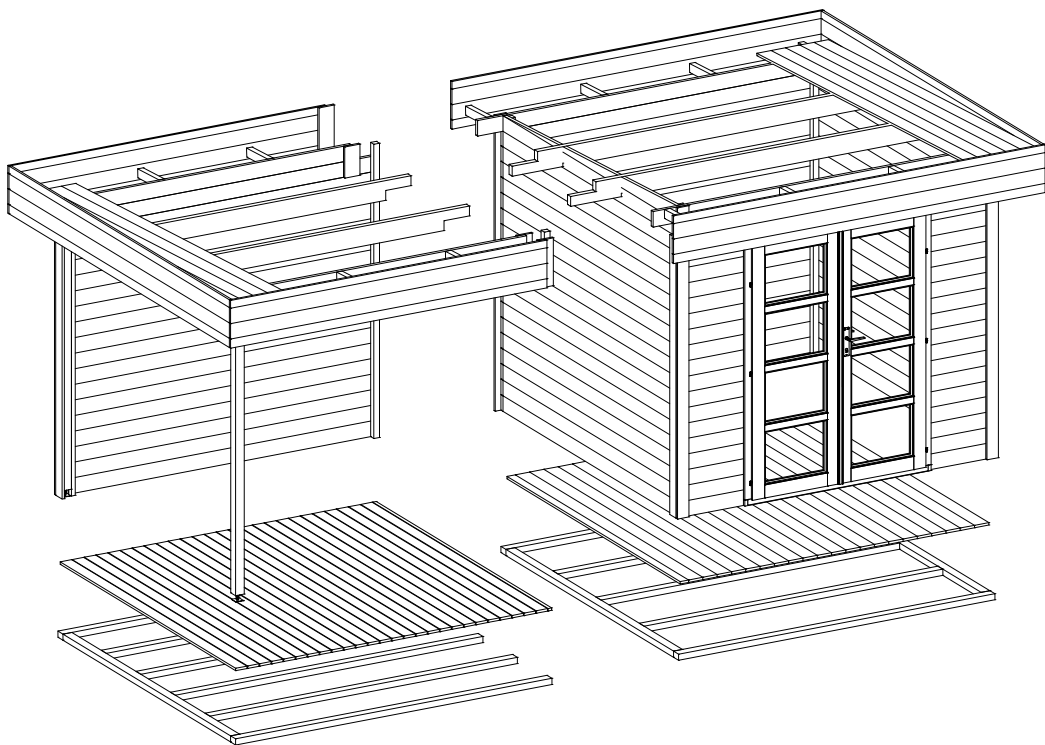
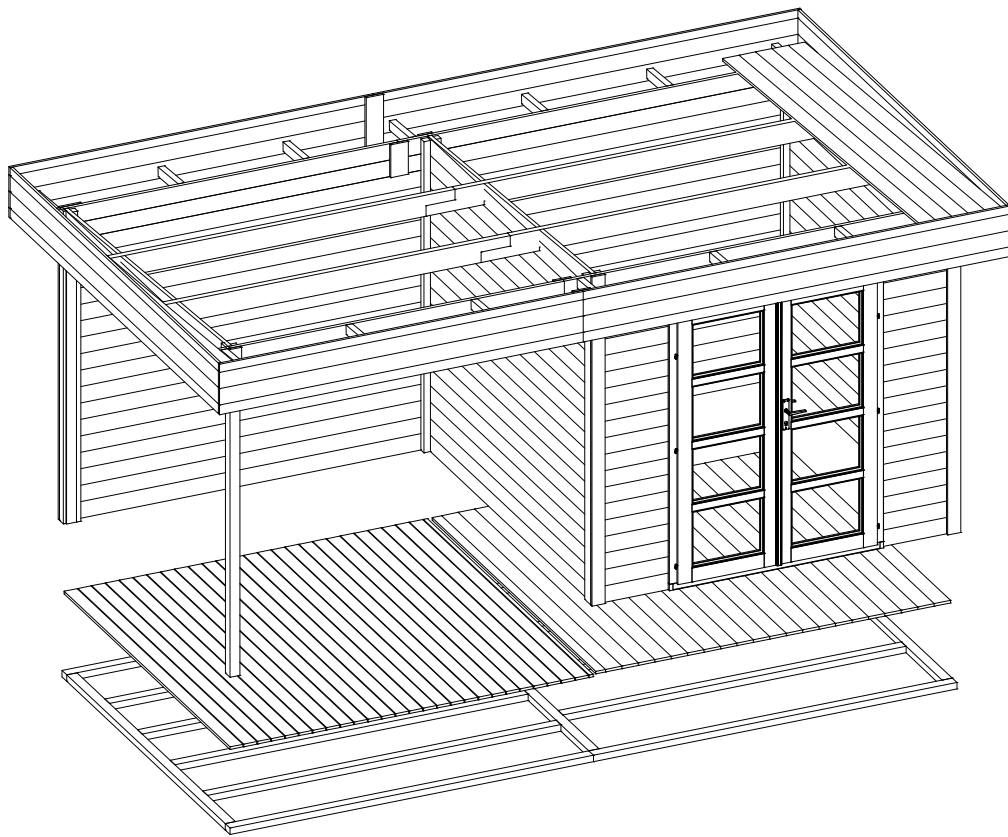

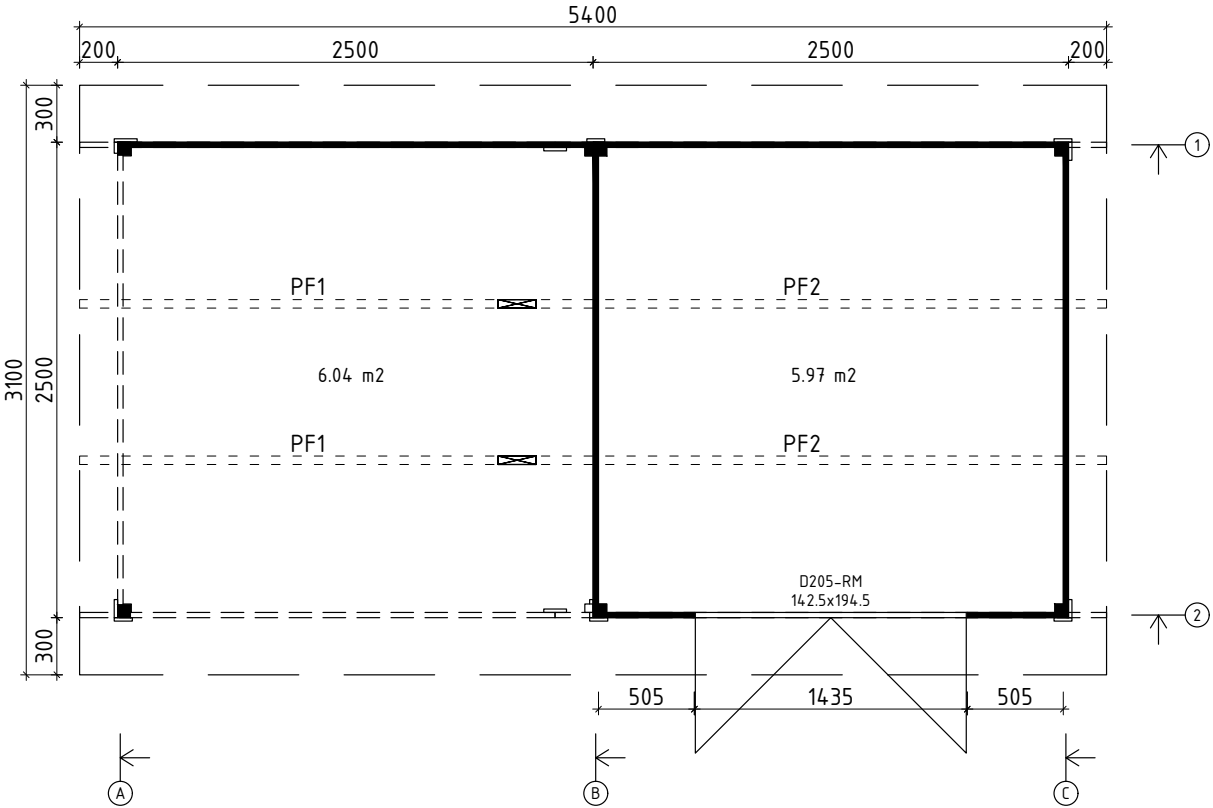





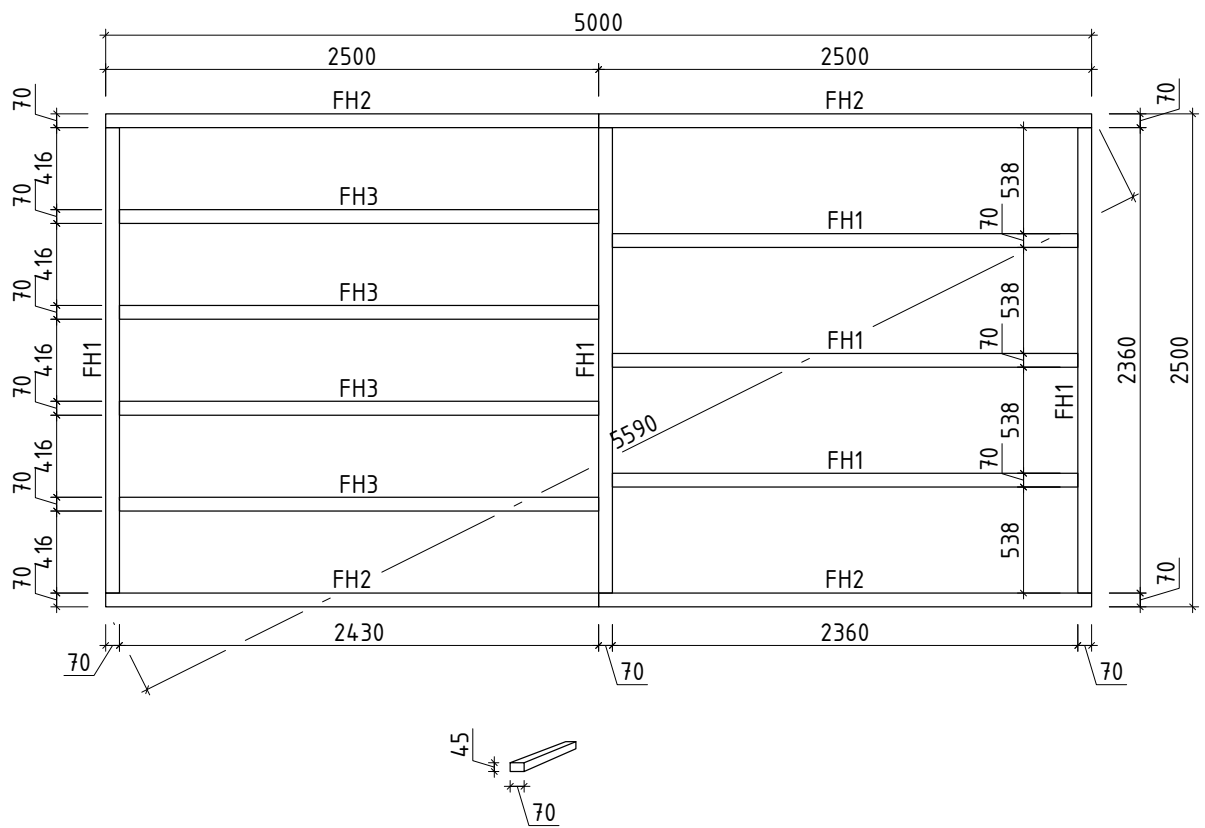

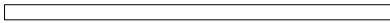
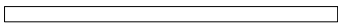

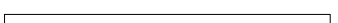

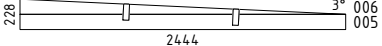
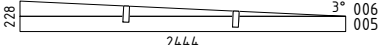
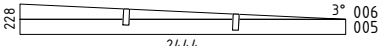













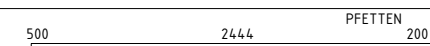

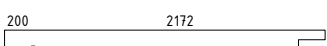



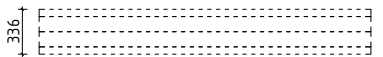
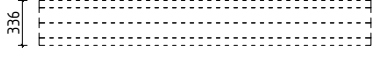
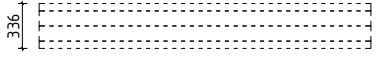
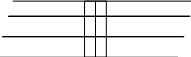

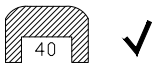

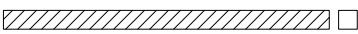
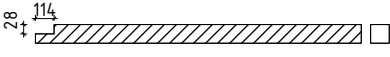

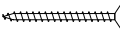
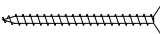
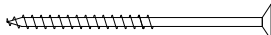
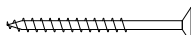
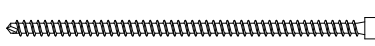

Q2 - Qualitätsklasse für Fenster und Türen

Wir empfehlen als Fundament für Ihr Gartenhaus eine vollflächig festgegründete, gepflasterte oder betonierte Fläche. Wahlweise ist auch ein Punkt- oder Streifenfundament möglich.

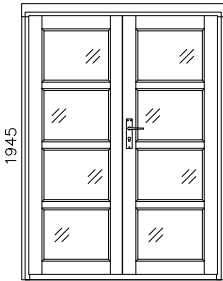
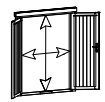

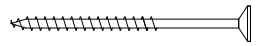
Pos		Stck	Profil (mm)	Länge (mm)
001		2	28x114	2900
002		2	28x114	2500
003		21	28x114	2500
004		1	28x114	2500
005		37	28x114	2444
007		17	28x114	2432
008		34	28x114	518
WA-1		1		
WB-1		1		
WC-1		1		
FH2	FUNDAMENTHÖLZER (imprägniert) 	4	70x45	2500
FH3	FUNDAMENTHÖLZER (imprägniert) 	4	70x45	2430
FH1	FUNDAMENTHÖLZER (imprägniert) 	6	70x45	2360
LE1	LEISTE 	1	120x18	2166
LE3	LEISTE 	2	120x18	228
LE6	LEISTE 	✓ 4	95x18	2280
LE4	LEISTE 	✓ 3	95x18	2166
LE2	LEISTE 	✓ 2	95x18	342
LE5	LEISTE 	✓ 1	58x18	2166
LE7	LEISTE 	2	15x28	1938
EP4	ECKPFOSTEN 	2	44x44	2270
EP3	ECKPFOSTEN 	3	44x44	2156
EP1	ECKPFOSTEN 	3	44x44	218
EP2	ECKPFOSTEN 	1	30x40	1938
PF2	PFETTEN 	2	44x145	3200

Pos		Stck	Profil (mm)	Länge (mm)
PF1	 PFETTEN	2	44x145	2400
	DACHBRETTEN 	49+1	113x18	3005
	FUSSBODENBRETTEN 	22+1	113x18	2440
	TERRASSENBRETTEN (imprägniert) 	27+1	90x18	2470
	FUSSBODENLEISTEN 		18x40	10,0 lfdm
BL-1	DACHBLENDEN 336mm 	2	18x336	2500
BL-2	DACHBLENDEN 336mm 	2	18x336	2936
BL-3	DACHBLENDEN 336mm 	2	18x336	3100
VL-1	DACHBLENDEN- Verbindungsleisten 	2	18x120	336
BS-1	DACHBLENDEN- Blendenstützen 44x65 	14	44x65	300
UPB-1	DACHBLENDEN- U-Profil für Blenden 		65x44	18,0 lfdm
DPL-1	DACHPAPPENLEISTEN 15x28 		15x28	12,0 lfdm
T06-1	TRAUFENLEISTEN 18x40 		18x40	11,0 lfdm
TP68-1	STÜTZPFOSTEN 68x68 	1	68x68	1940
TP68-2	STÜTZPFOSTEN 68x68 	1	68x68	2050
SH	Schlaghölzer 	3		
KP-1	DACHPAPPE 		6,1m-4st.	25,0 lfdm
NG01	DACHPAPPNÄGEL 2.8x15 	410		
NG04	NÄGEL 2.5x50 Dachbretter Fußbodenbretter, Terrassenbretter 	936		
SR32	SCHRAUBEN 3.0x30 Dachpappenleisten, Verbindungsleisten Fußbodenleisten, Traufenleisten 	82		
SR37	SCHRAUBEN 3.5x45 U-Profil LE1-LE7 	196		
SR44	SCHRAUBEN 4.0x60 Wandbohlen zu Eckpfosten 	416		
SR57	SCHRAUBEN 5.0x100 Fundamenthölzer 	56		
SR55	SCHRAUBEN 5.0x70 Blendenbefestigung Blendestützen, EP1, EP3 	56		
SR62	SCHRAUBEN 6.0x140 (ASSY für Pfetten) 	4		

Pos		Stck	Profil (mm)	Länge (mm)
	<p style="text-align: center;">TÜR 1425x1945 D2-D28R-LLM-14251945</p> <div style="display: flex; justify-content: space-between;"> <div style="text-align: center;"> <p>Q2 D205-RM 1425</p>  </div> <div style="border: 1px solid black; border-radius: 10px; padding: 5px; width: 150px;"> <p>Right handed / DIN rechts / paremakäeline</p> </div> </div> <div style="display: flex; justify-content: space-between; margin-top: 10px;"> <div style="text-align: center;"> <p>Clear opening/ durchgangsmaß/ ava suurus 1337x1857mm</p>  </div> <div style="border: 1px solid black; border-radius: 10px; padding: 5px; width: 100px;"> <p>matt glass Floatglas Safiniert matt klaas 492x382mm</p>  </div> </div>	1		
SR25 15-01	2.5x15 Locking plate - Schließblech - Riivi vastus 01 Q2-Q3		2	
SR50 90-01	5.0x90 Door frames - Türrahmen - Ukselengid		8	
RV01	Locking plate - Schließblech - Riivi vastus 01 Q2-Q3		1	
UL-Q 2-Q3	Q2-Q3 Door handle - Türgriff - Ukselink		1	
LS-Q4	Q4 Cylinder lock - Zylinderschloss - Lukusüdamik		1	
	<p>✓ - bitte selber anpassen (falls nötig)!</p>			

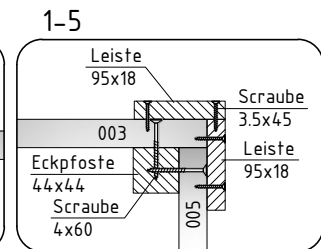
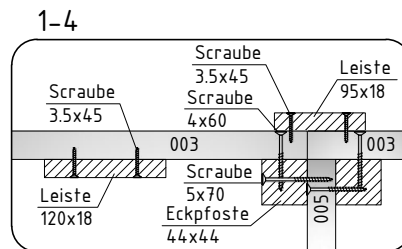
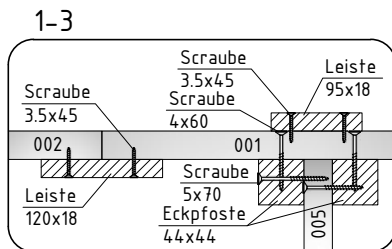
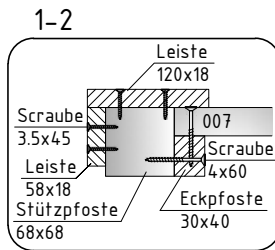
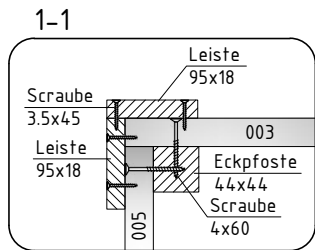
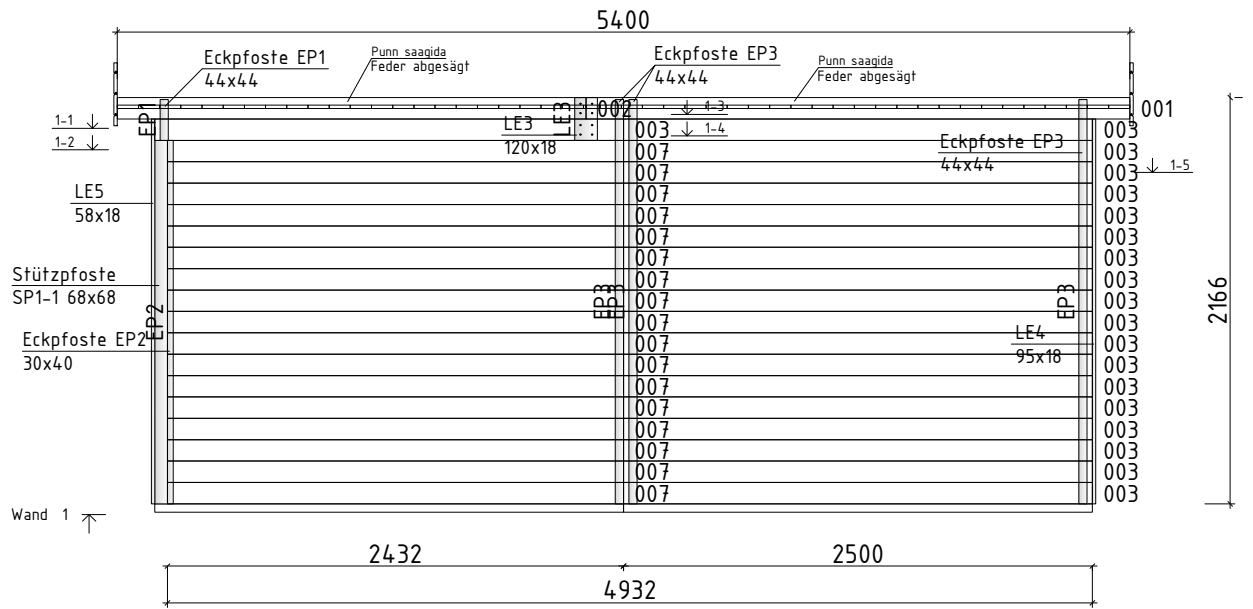

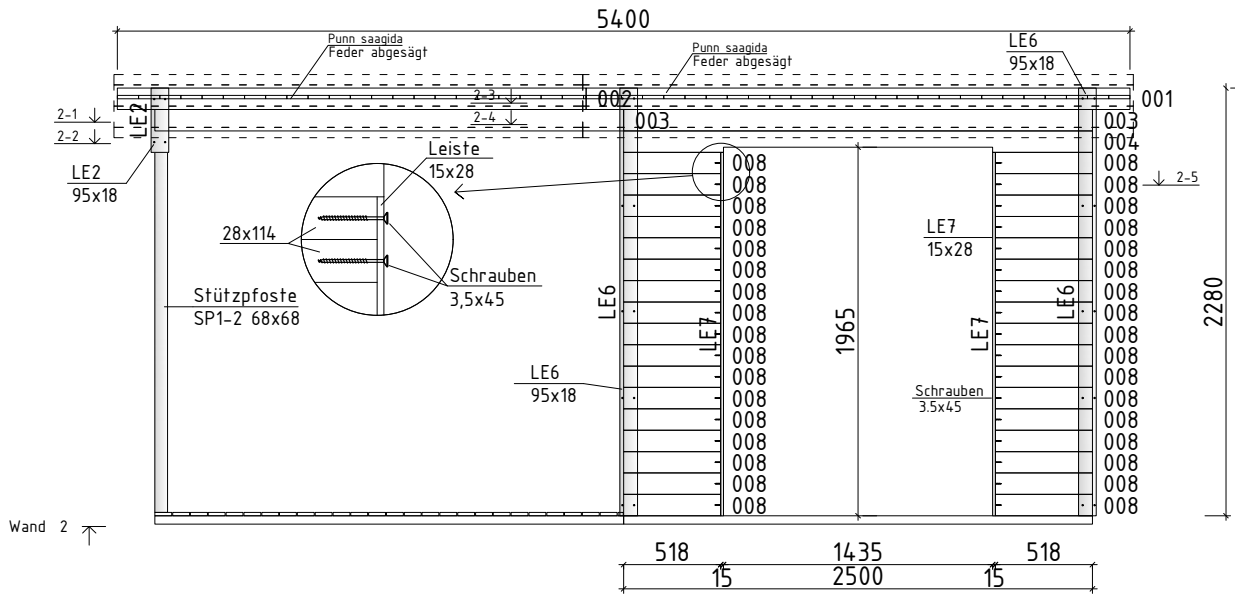

2-1

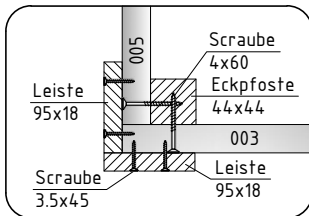

2-2

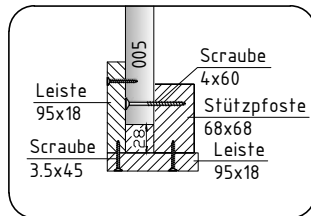

2-3

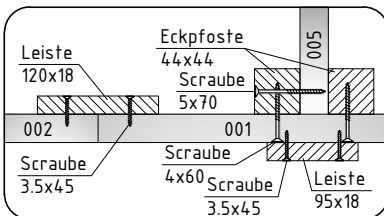

2-4

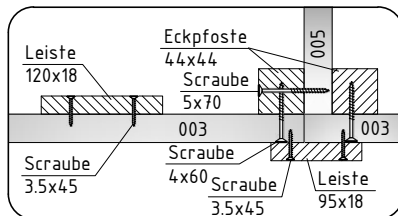

2-5

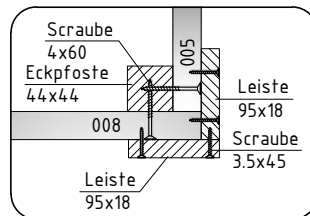

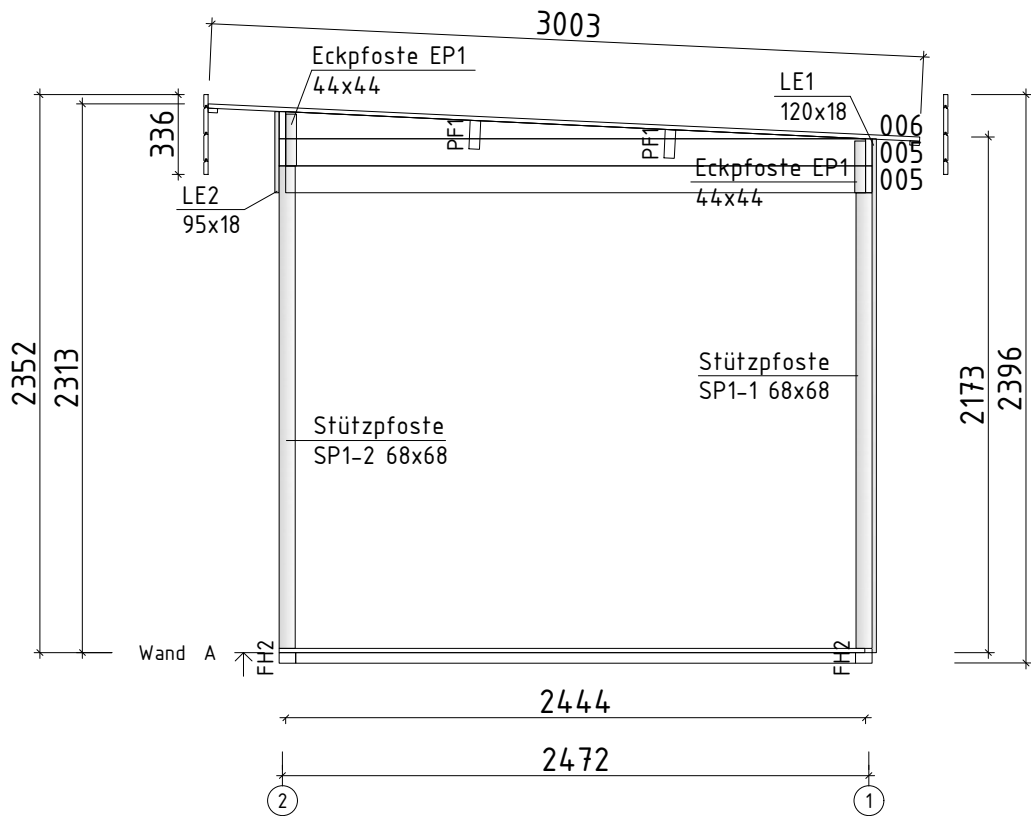
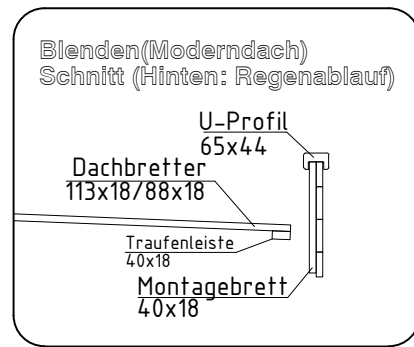
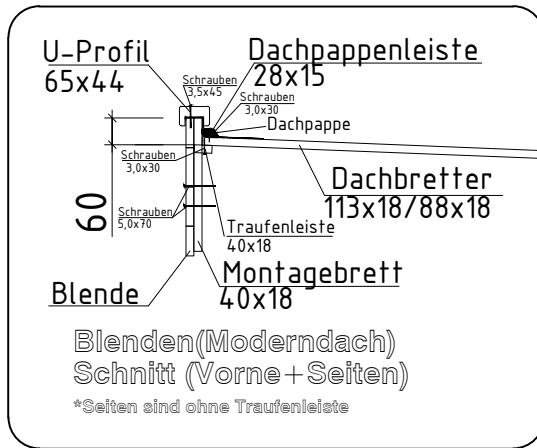

2 Schrauben für Bohle

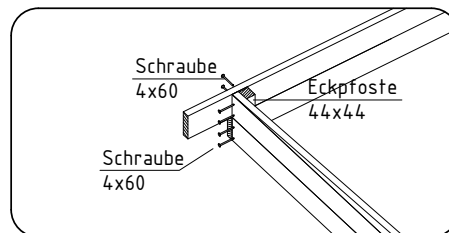

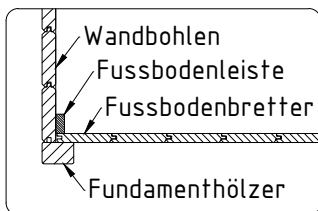
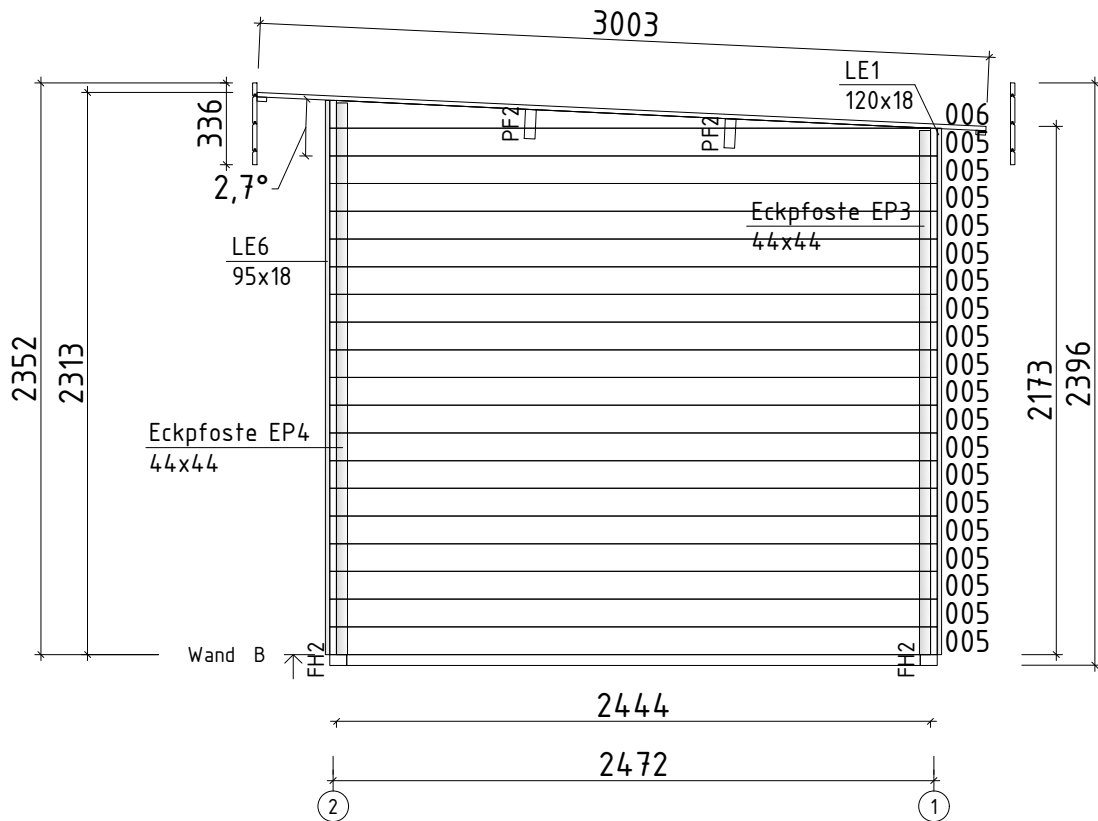

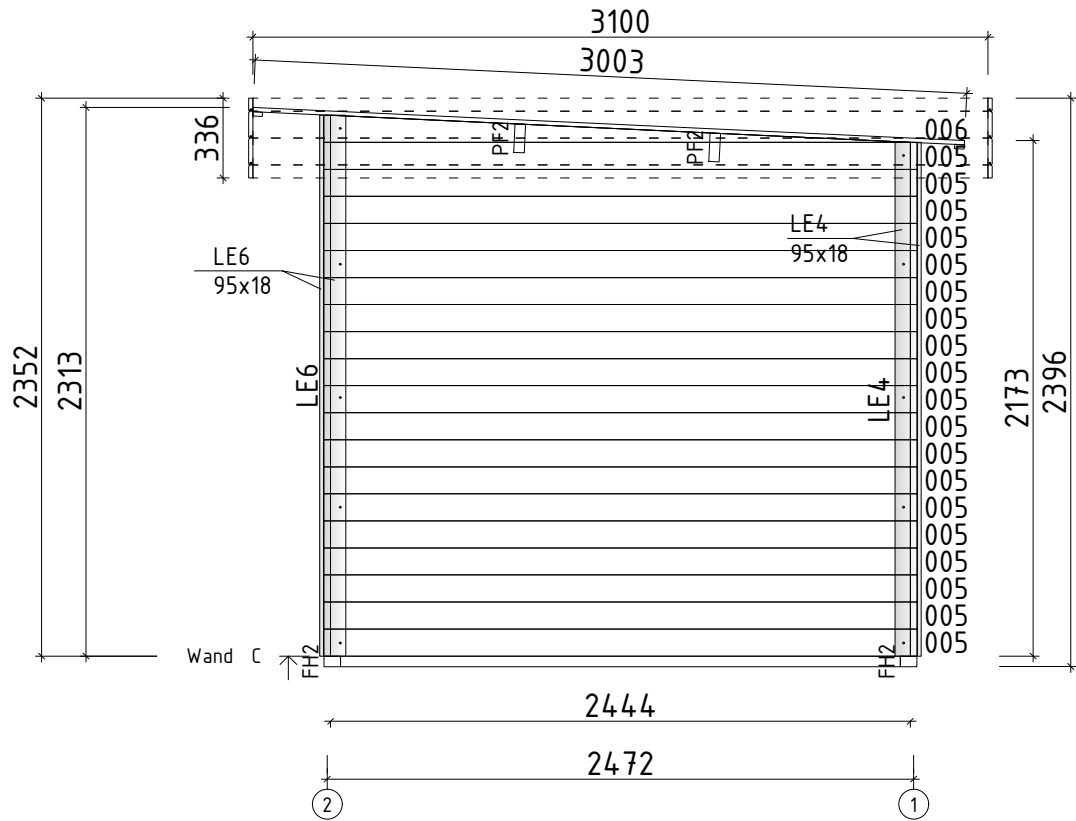

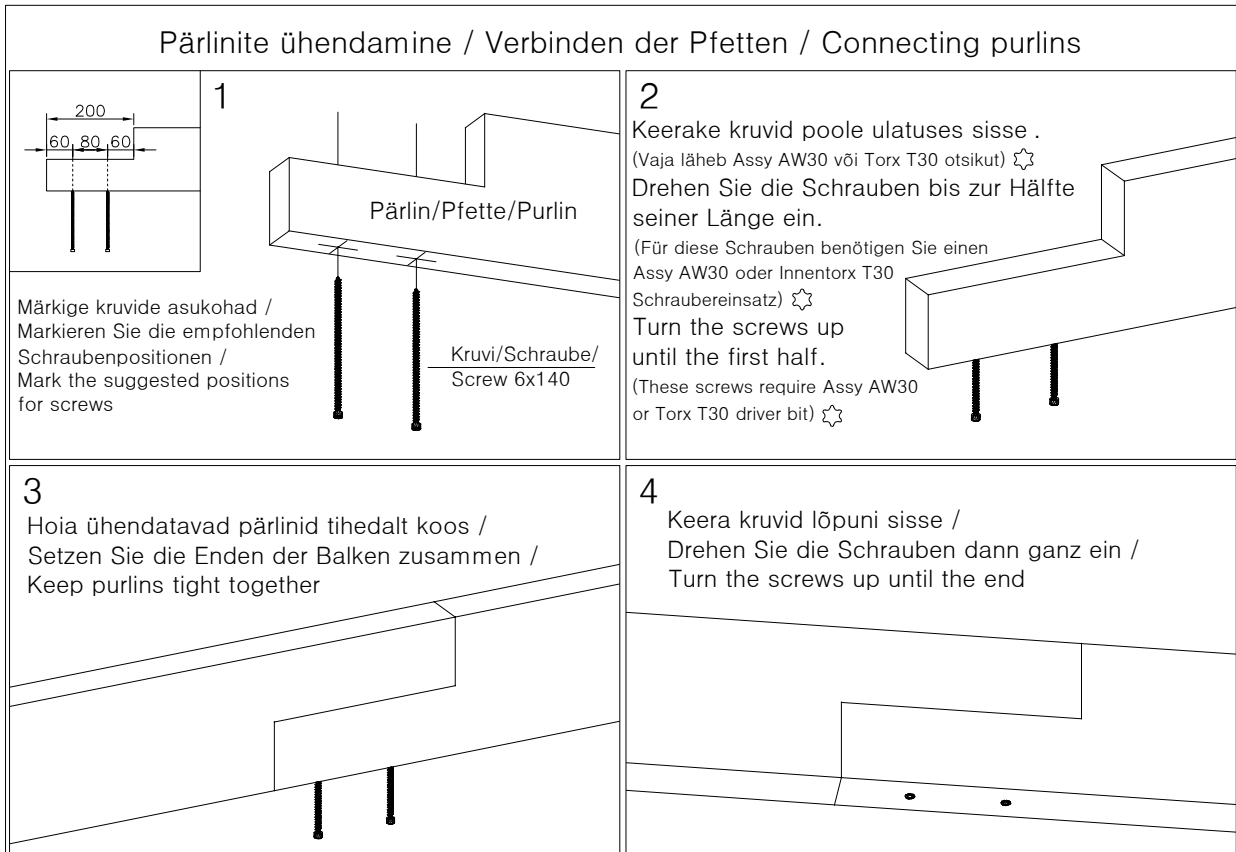

Uks	Q2-Q3	-	koostamisjuhised
Door	Q2-Q3	-	assembly instructions
Tür	Q2-Q3	-	Montageanleitung

5x90

5x90

5x90

5x90

5x90

5x90

5x90

5x90

5x90

Ø8-10

1. / 2.

1.

2.

1.

Ø8-10

*Kui hinged ei ole paigaldatud!
 *When hinges are not attached!
 *Wenn Scharniere sind nicht angebracht!

Plot date: 29.04.2020

*Kui ühepoolne uks ei ole kokku pandud!
 *When single door is not assembled!
 *Wenn Einzeltür ist nicht zusammengebaut!