

# Technische Daten

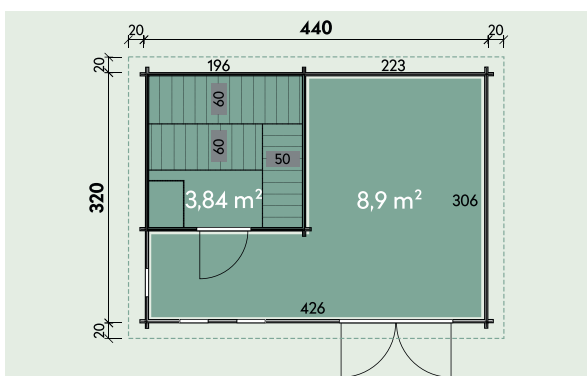

## Artikelnummer:

350 150



**Kontrolliert durch:**

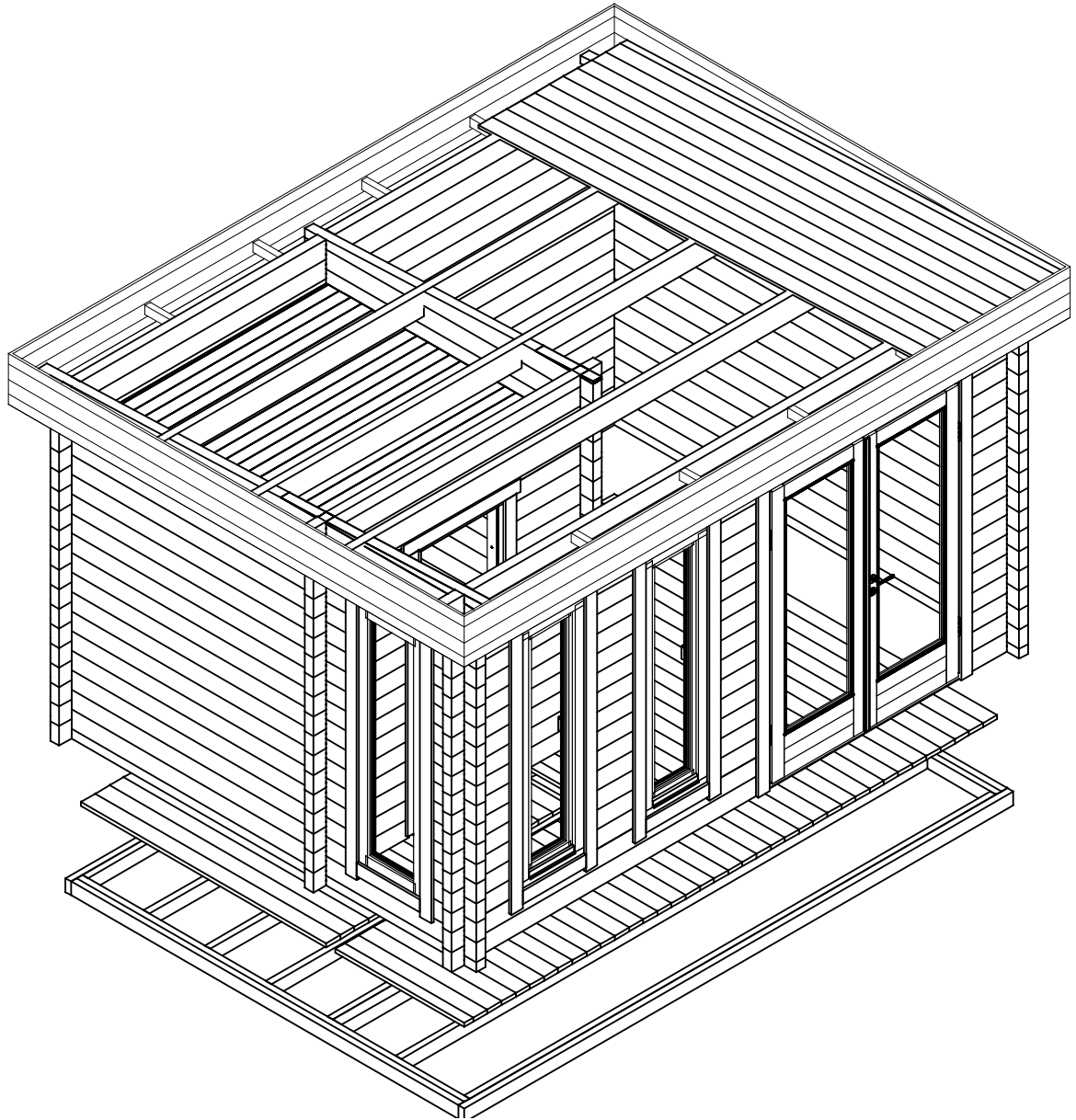

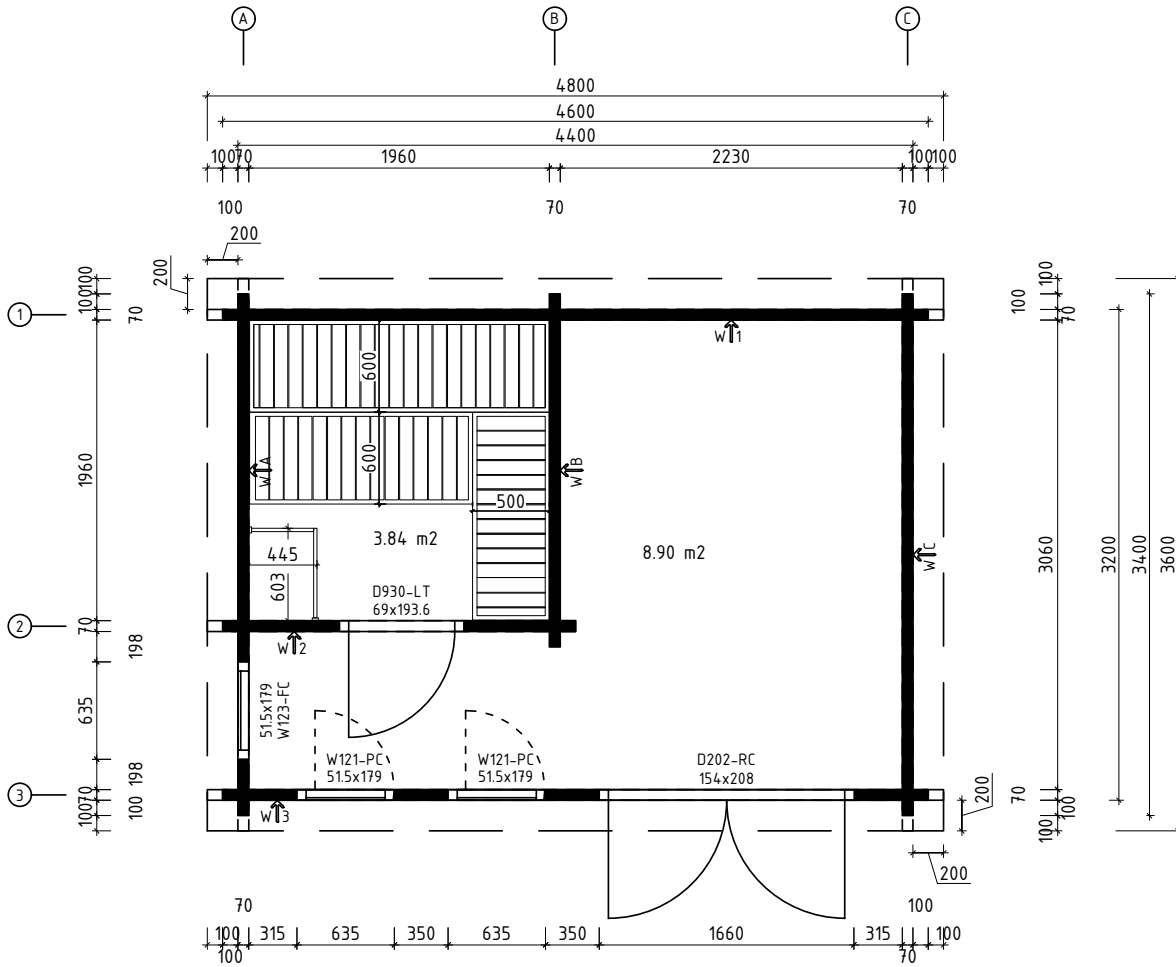





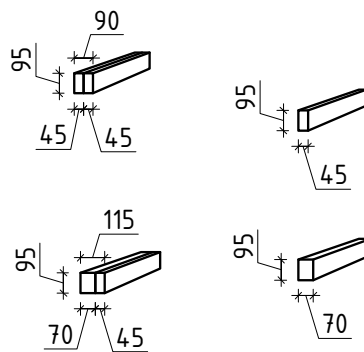
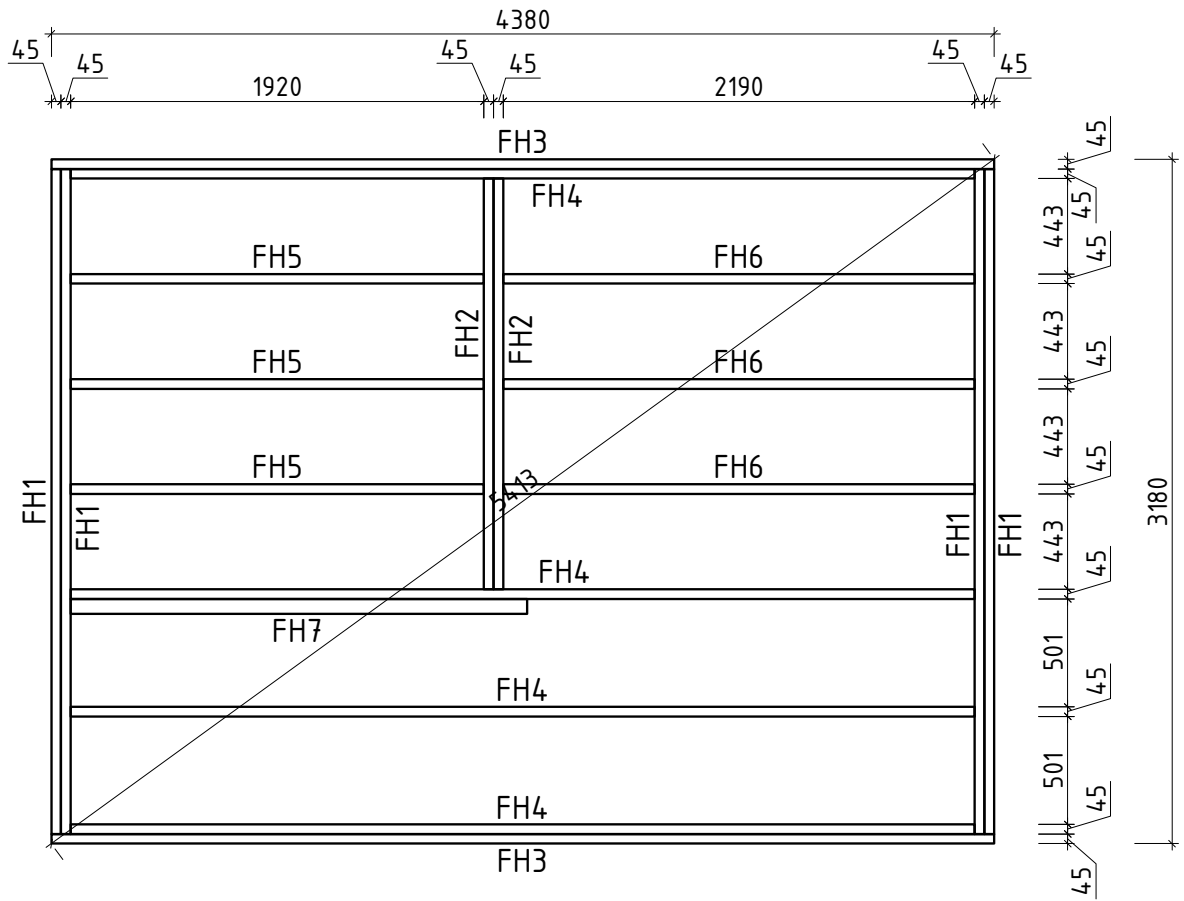

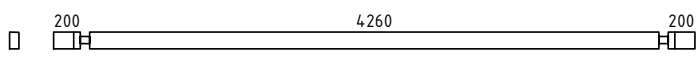
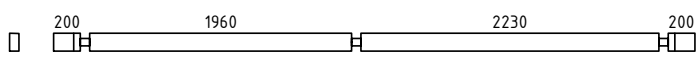
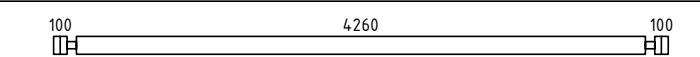
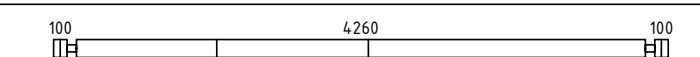
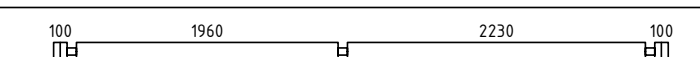
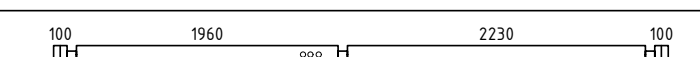
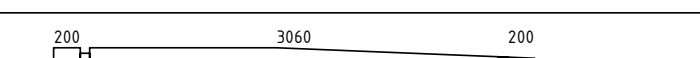
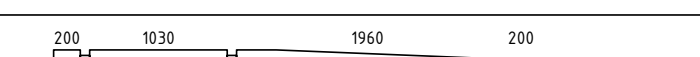
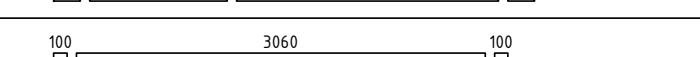
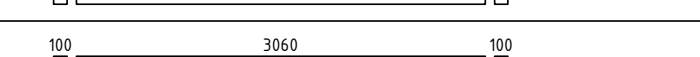
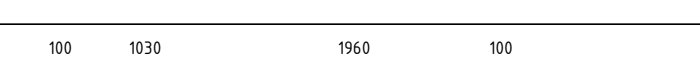
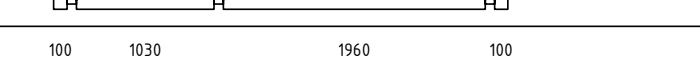
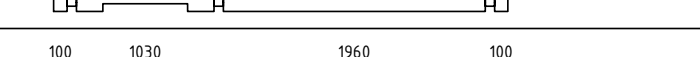
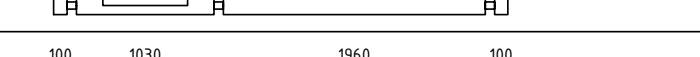
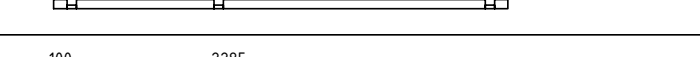
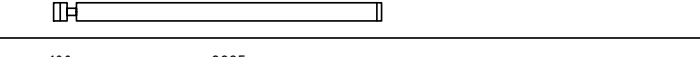
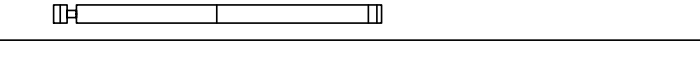
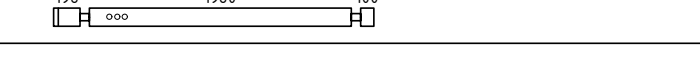
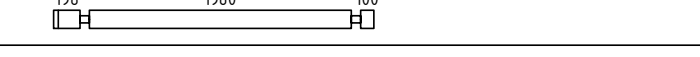
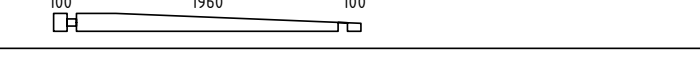
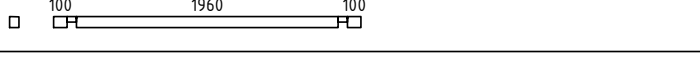
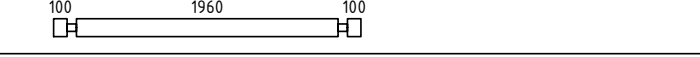
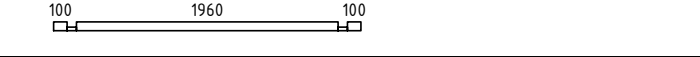









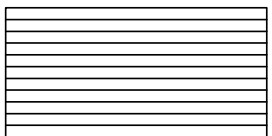

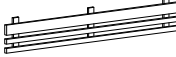

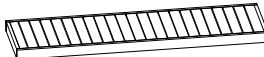
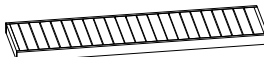

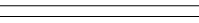
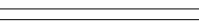

**Q4** – Qualitätsklasse für Fenster und Türen  
 \* Fenster und Türen sind ohne Sprossen



















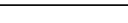
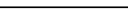
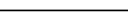

**Wir empfehlen als Fundament für Ihr Gartenhaus eine vollflächig festgegründete, gepflasterte oder betonierte Fläche. Wahlweise ist auch ein Punkt- oder Streifenfundament möglich.**





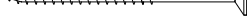
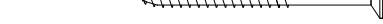
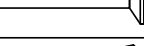

Pos		Stck	Profil (mm)	Länge (mm)
001		1	70x127	4800
002		1	70x135	4800
003		1	70x135	4600
004		1	70x135	4600
005		15	70x135	4600
006		2	70x135	4600
007		1	70x135	3600
008		1	70x135	3600
009		17	70x135	3400
010		1	70x68	3400
011		2	70x135	3400
012		1	70x135	3400
013		1	70x135	3400
014		1	70x68	3400
015		1	70x135	2455
016		1	70x135	2455
017		1	70x135	2398
018		12	70x135	2398
019		1	70x135	2300
020		1	70x82	2300
021		20	70x135	2300
022		1	70x68	2300
023		1	70x68	1665
024		1	70x68	1665
025		15	70x135	763

Pos		Stck	Profil (mm)	Länge (mm)
026		15	70x135	728
027		30	70x135	485
028		1	70x19	465
029		13	70x135	368
030		20	70x135	350
031		8	70x135	350
FH7	FUNDAMENTHÖLZER (imprägniert) 	1	70x95	2120
FH3	FUNDAMENTHÖLZER (imprägniert) 	2	45x95	4380
FH4	FUNDAMENTHÖLZER (imprägniert) 	4	45x95	4200
FH1	FUNDAMENTHÖLZER (imprägniert) 	4	45x95	3090
FH6	FUNDAMENTHÖLZER (imprägniert) 	3	45x95	2190
FH5	FUNDAMENTHÖLZER (imprägniert) 	3	45x95	1920
FH2	FUNDAMENTHÖLZER (imprägniert) 	2	45x95	1908
HS1	HOLZSCHWELLE (unter der Saunatür) 	✓ 1	75x28	750
PF1	PFETTEN 	2	58x170	4800
PF2	PFETTEN 	1	58x170	4800
	DACHBRETTER	43+1	113x18	3505
	FUSSBODENBRETTER	20+1	113x28	3055
	FUSSBODENBRETTER	18	113x28	1955
	FUSSBODENBRETTER	18	113x28	1025
	FUSSBODENLEISTEN	✓	14x55	25.0l fm
	DECKENLEISTEN	✓	15x28	18.0l fm
BL-1	DACHBLENDEN 336mm 	2	18x336	3600
BL-2	DACHBLENDEN 336mm 	2	18x336	4836
BS-1	DACHBLENDEN- Blendenstützen 44x65 	8	44x65	200

Pos		Stck	Profil (mm)	Länge (mm)
UPB-1	DACHBLENDEN- U-Profil für Blenden 	✓	65x44	17.5lfm
DPL-1	DACHPAPPENLEISTEN 15x28 	✓	15x28	12.0lfm
T06-1	TRAUFENLEISTEN 18x40 	✓	18x40	10.0lfm
	DECKENISOLATION  	2 Elemente	ca 1950x975	
SA16-2-1	SAUNA - Bänke Zwischenstück 2 	1	46x300	1955
SA15-2-1	SAUNA - Rücklehne 2 	2	72x250	1860
SA02-1	SAUNA - Saunabank 50cm 	1	500x90	1355
SA01-1	SAUNA - Saunabank 60cm 	2	600x90	1955
SA11-1	SAUNA - Stützpfeiler für Saunabänke 	✓	1	44x65 500
SA11-2	SAUNA - Stützpfeiler für Saunabänke 	✓	2	44x65 1000
SA20-1	SAUNA - Trägleiste für Deckenisolation 	✓	4	35x35 2010
SA10-1	SAUNA - Trägleiste für Saunabänke 	✓	1	30x40 500
SA10-2	SAUNA - Trägleiste für Saunabänke 	✓	2	30x40 600
SA10-3	SAUNA - Trägleiste für Saunabänke 	✓	2	30x40 1200
SA37	SAUNA - Bodenrost 	1		
SA30	SAUNA - Heizung Umbau (set 1) 	1		
SA35	SAUNA - Kopfstütze 	2		
SA36	SAUNA - Luftschieber 	3		
TL70-1	T-LEISTE 70 	2	45x70	1705
TL70-2	T-LEISTE 70 	4	45x70	1840
TL70-3	T-LEISTE 70 	2	45x70	1975
TL70-4	T-LEISTE 70 	2	45x70	2110
SH	Schlaghölzer 	3		

Pos		Stck	Profil (mm)	Länge (mm)
SA2 5-1	SAUNA - Dichtungsband für Deckenisolationselemente 			8.0lfm
ML1	Metallstange 	4	D10	900
ML2	Metallstange 	2	D10	770
NG01	DACHPAPPNÄGEL 2.8x15 	400		
NG2 550	NÄGEL 2.5x50 Dachbretter 	430		
SR3 030	SCHRAUBEN 3.0x30 Dachpappeleisten 	26		
SR3 030	SCHRAUBEN 3.0x30 Deckenleisten 	34		
SR3 030	SCHRAUBEN 3.0x30 Fussbodenleisten 	46		
SR303 0-002	SCHRAUBEN 3.0x30 Sauna- Bänke Zwischenstück 	6		
SR303 0-001	SCHRAUBEN 3.0x30 Sauna- Luftschieber 	18		
SR3 030	SCHRAUBEN 3.0x30 Traufenleisten 	20		
SR354 5-002	SCHRAUBEN 3.5x45 Sauna- Heizung Umbau 	8		
SR3 547	SCHRAUBEN 3.5x45 C3 Fenster- und Türleisten 	128		
SR3 547	SCHRAUBEN 3.5x45 C3 U-Profil 	36		
SR406 0-001	SCHRAUBEN 4.0x60 Sauna- Trägleiste für Deckenisolation 	28		
SR406 0-002	SCHRAUBEN 4.0x60 Sauna- Trägleiste für Saunabänke 	21		
SR4 257	SCHRAUBEN 4.2x55 C2 28mm Fussbodenbretter 	601		
SR5 0100	SCHRAUBEN 5.0x100 Fundamenthölzer 	76		
SR5 070	SCHRAUBEN 5.0x70 Blendenbefestigung 	44		
SR507 0-001	SCHRAUBEN 5.0x70 Sauna- Stützpfeiler für Saunabänke 	10		
SR509 0-001	SCHRAUBEN 5.0x90 Sauna- Rücklehne 2 	12		
SR56	SCHRAUBEN 5.0x90 D930-LT 	6		
SR6 0140	SCHRAUBEN 6.0x140 Blendenstützen 	16		
SS023	Schloßschrauben M8x70 Mutter M8 U-Scheibe Ø25 - Befestigung für Saunabänke 	2		
KL1	Gewindestange M8 	4		2000

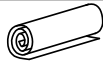
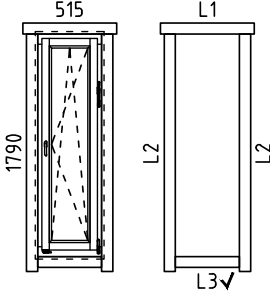
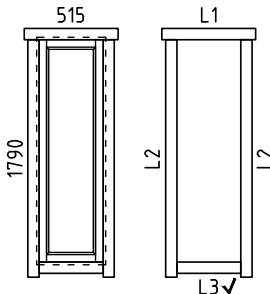
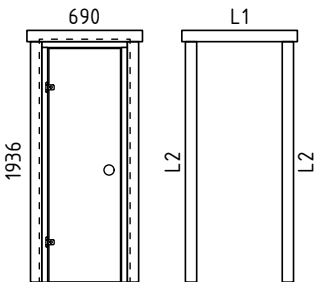

Pos		Stck	Profil (mm)	Länge (mm)
KL2	Gewindestange M8 	2		587
KL3	Gewindestange M8 	2		460
KV M UT M8	Mutter M8 	8		
KV S EIB M8X25	U-Scheibe M8 Ø25 	8		
KV MU TJ M8	Befestigungsmutter M8 	4		
KP-1	DACHPAPPE 	✓	5.5m-5'st	30.0lfm
	<p>FENSTER 515x1790 Q4 W4-S70P-0XC-05151790</p>  <p>W121-PC</p> <p>L1 18x90 L=755mm 2x L2 18x90 L=1910mm 4x L3 18x90 L=515mm 2x ✓</p>	2		
	<p>FENSTER 515x1790 Q4 W4-S70F-0XC-05151790</p>  <p>W123-FC</p> <p>L1 18x90 L=755mm 2x L2 18x90 L=1910mm 4x L3 18x90 L=515mm 2x ✓</p>	1		
	<p>TÜR 690x1936 D0-L70L-0XT-06901936</p>  <p>D930-LT</p> <p>L1 18x90 L=930mm 2 Stck. L2 18x90 L=1935mm 4 Stck. ✓</p> <p>DIN links</p>	1		

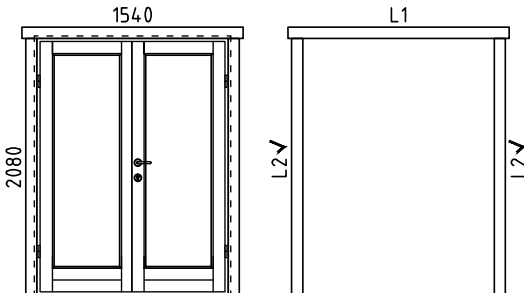
Pos		Stck	Profil (mm)	Länge (mm)
	<p style="text-align: center;">TÜR 1540x2080 Q4 D4-D70R-0XC-15402080</p>  <p style="margin-left: 500px;">D202-RC L1 18x90 L=1780mm 2x L2 18x90 L=2080mm 4x ✓ DIN rechts</p>	1		
	Achtung! Die Giebelbohlen können teilweise schon vormontiert sein! Bitte beachten - diese erscheinen nicht ganz so wie in der Teileliste beschrieben.			
	✓ - bitte selber anpassen (falls nötig)!			

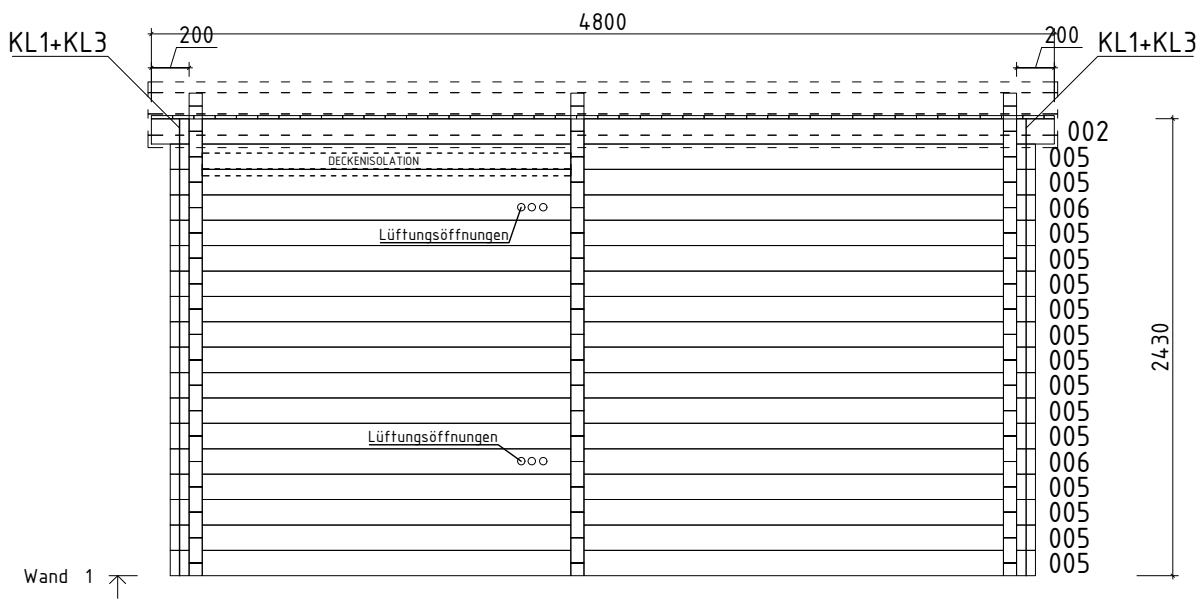

Wand 1 ↗

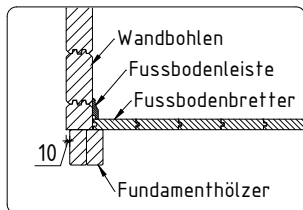
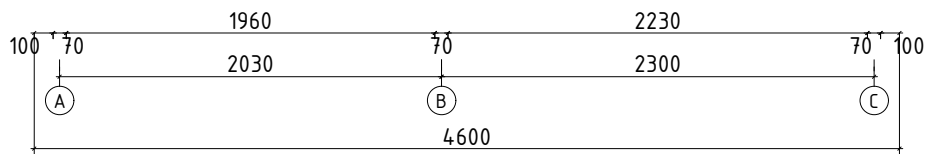

Die Bohlen mit Lüftungsöffnungen können je nach Bedarf höher oder niedriger eingesetzt werden. Bitte achten Sie darauf dass die Lüftungsöffnungen von innen nicht mit der Saunabank bedeckt werden!

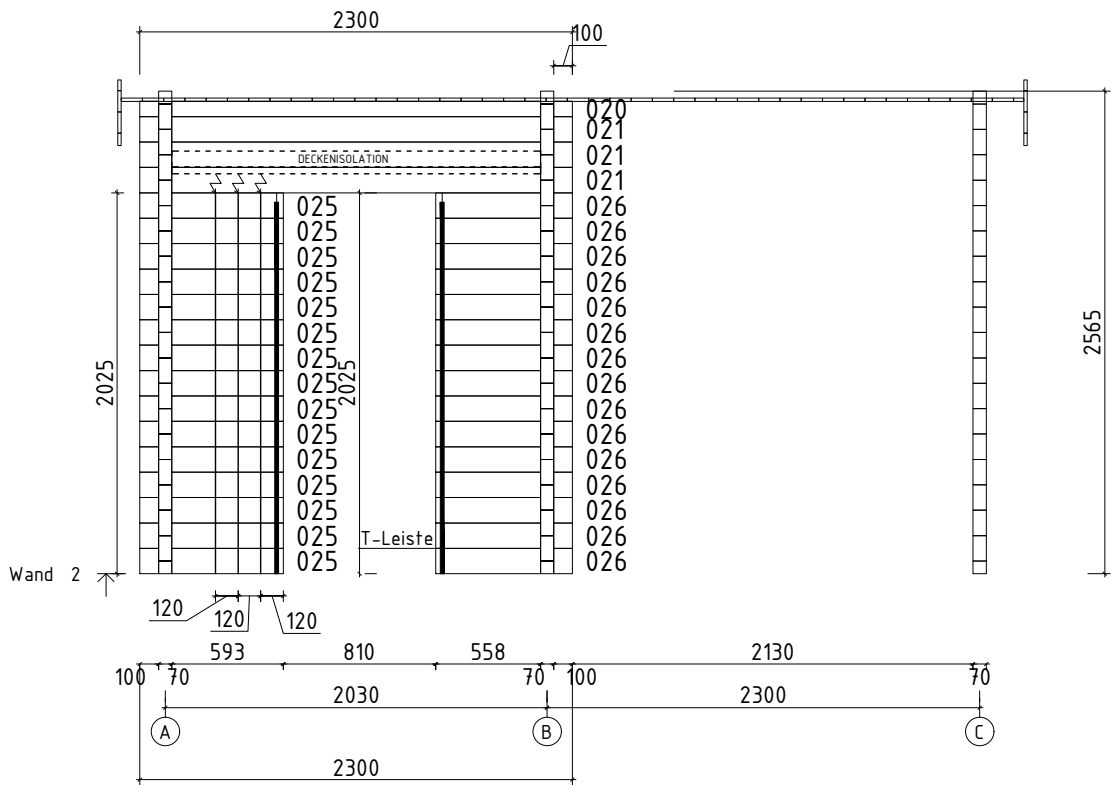

↘ -Bohrung für elektrische Kabel

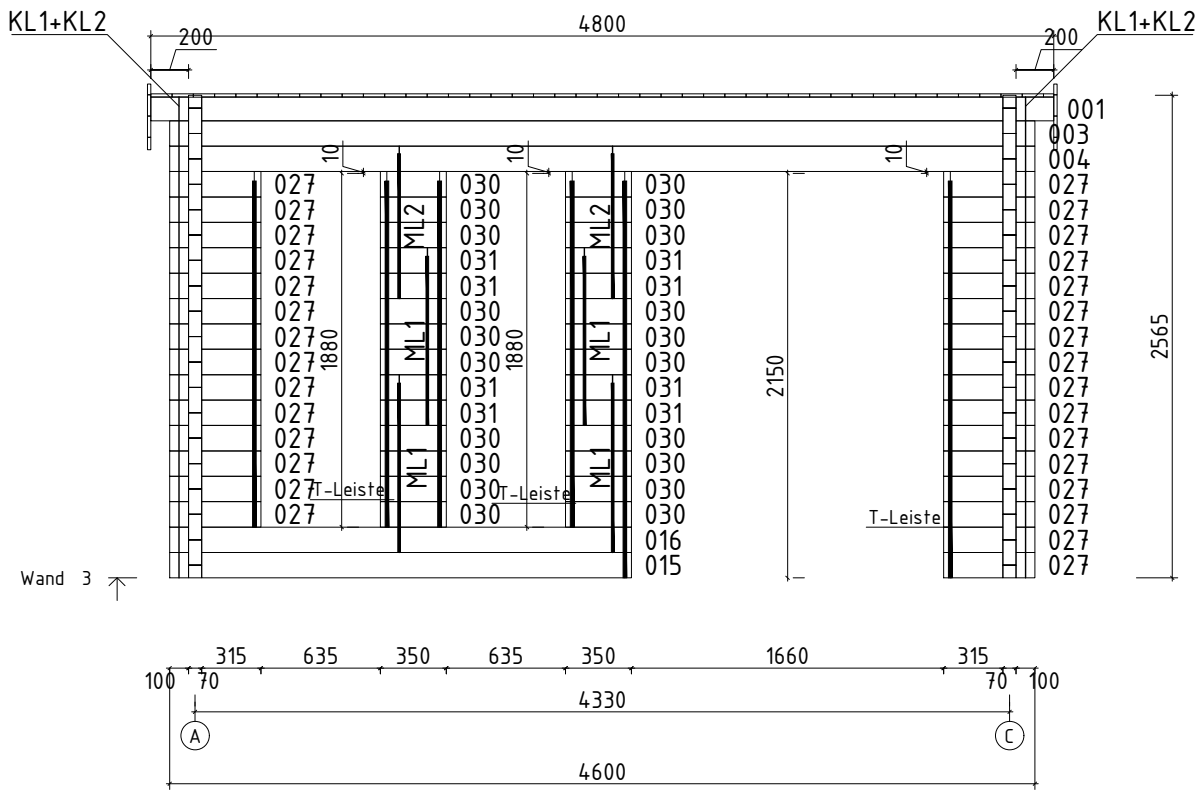



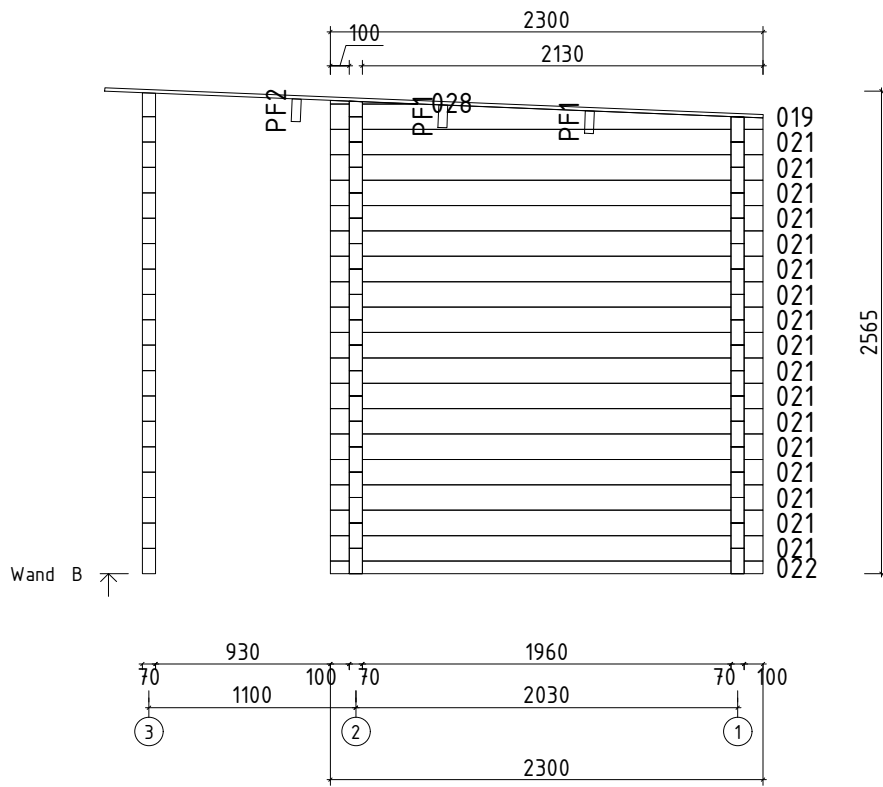

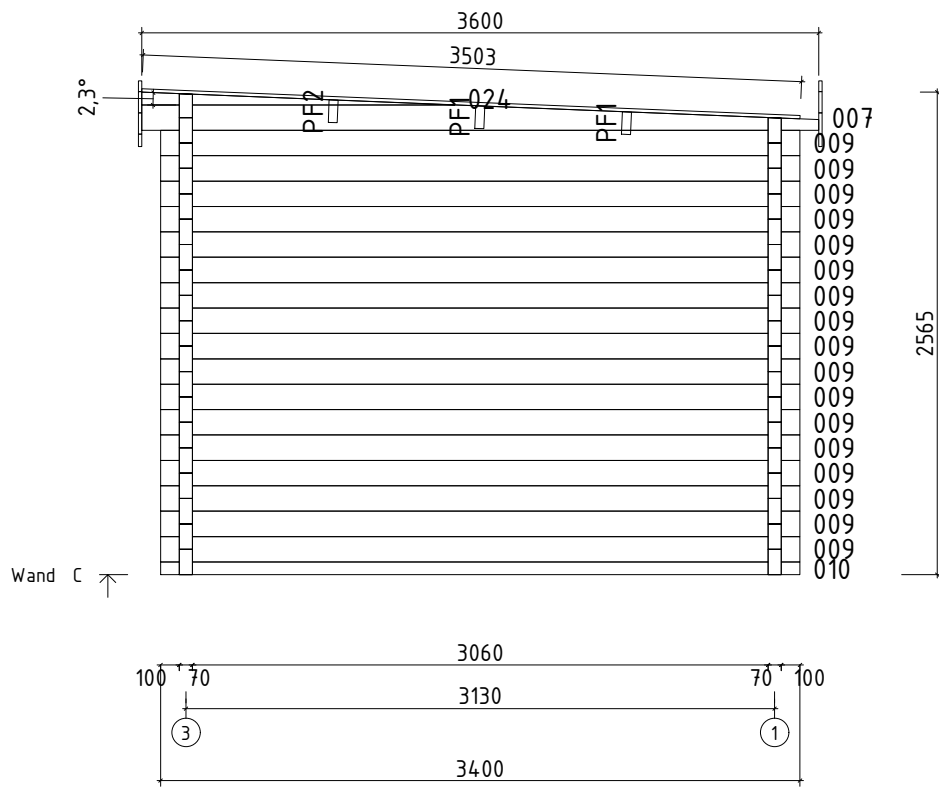



## Montageanleitung für T-leisten / Installing the door and window supports / Tenderliistu paigaldusjuhend.

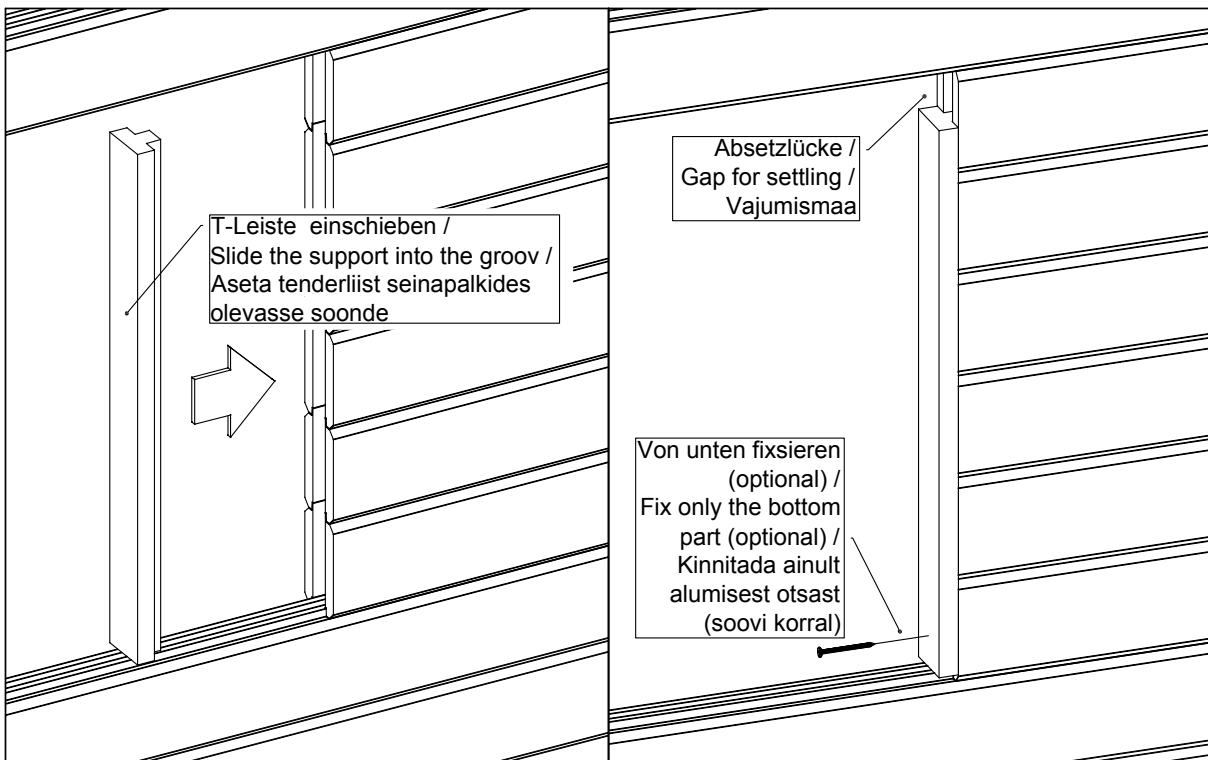

Aken Q4-Q6 - paigaldusjuhised  
 Window Q4-Q6 - assembly instructions  
 Fenster Q4-Q6 - Montageanleitung

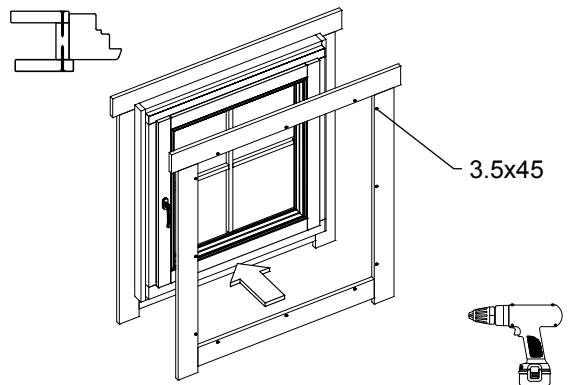
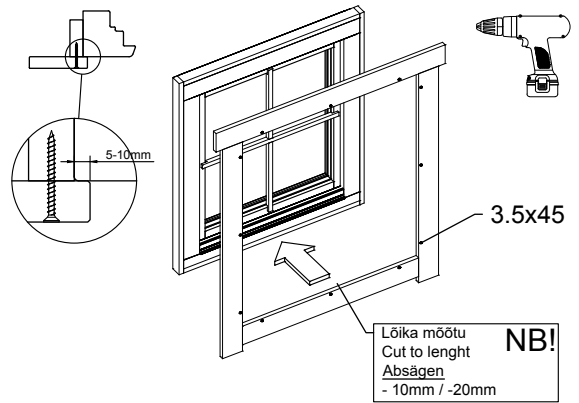
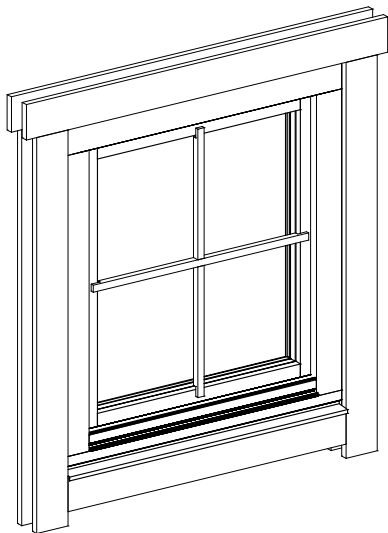

Veeplekk / Window sill / Fensterbank

Q4

1

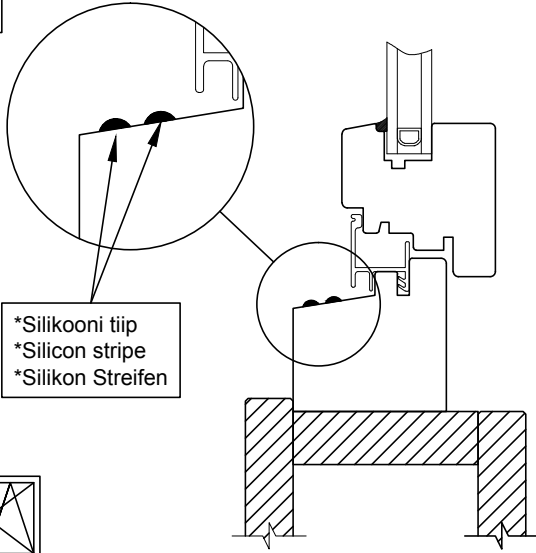

2

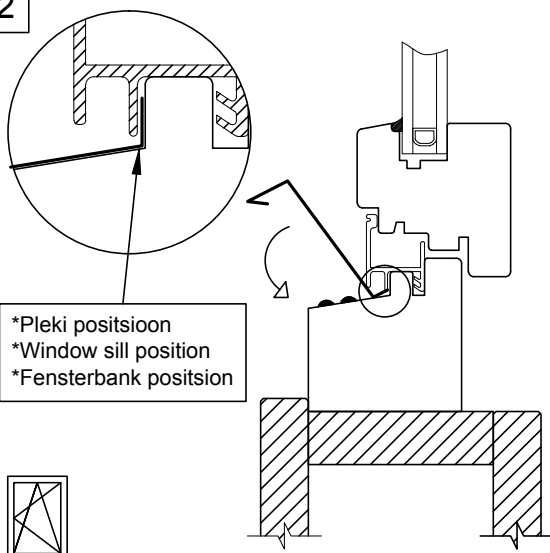

3

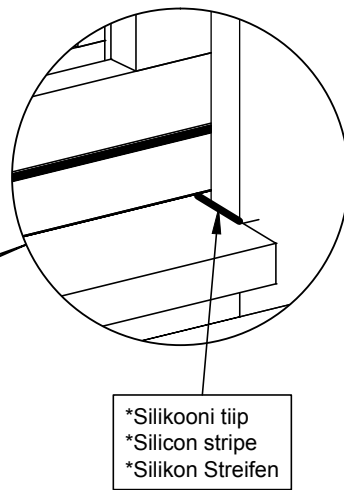
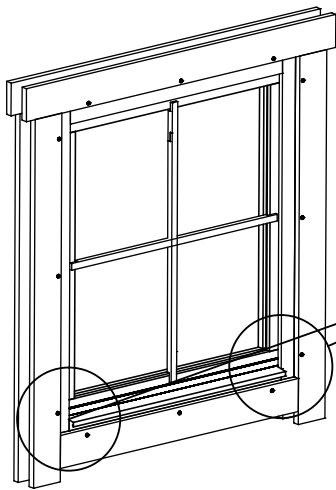

1

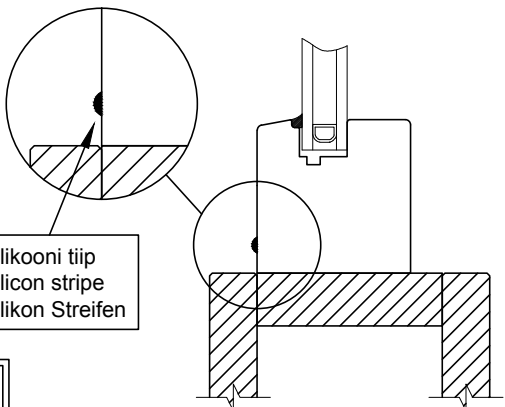

2

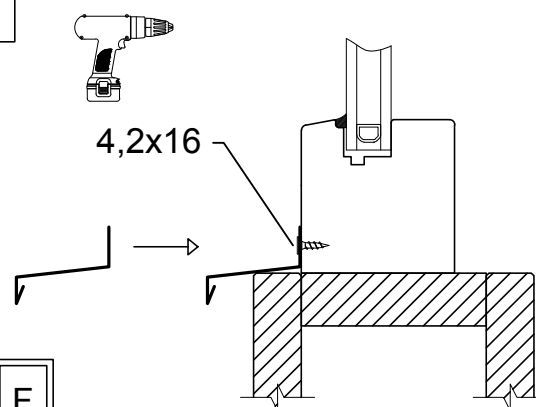

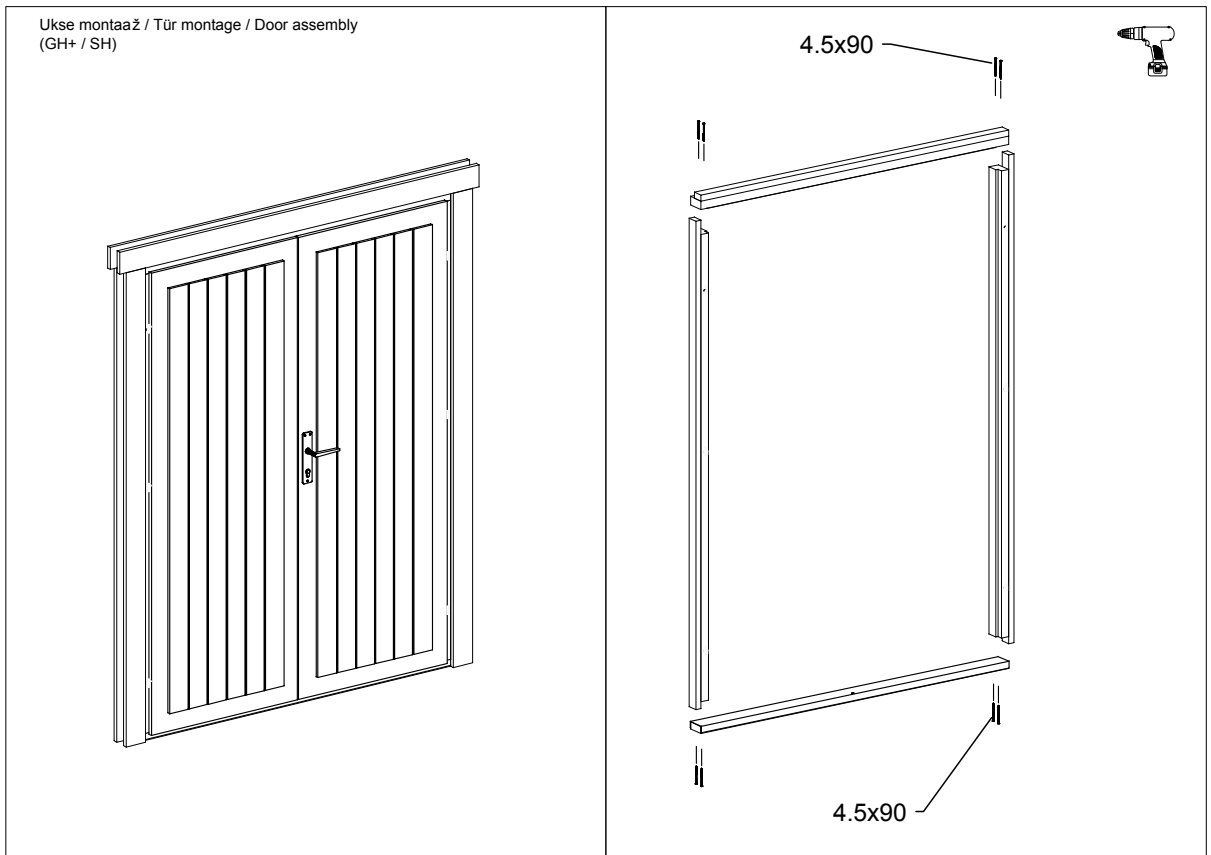

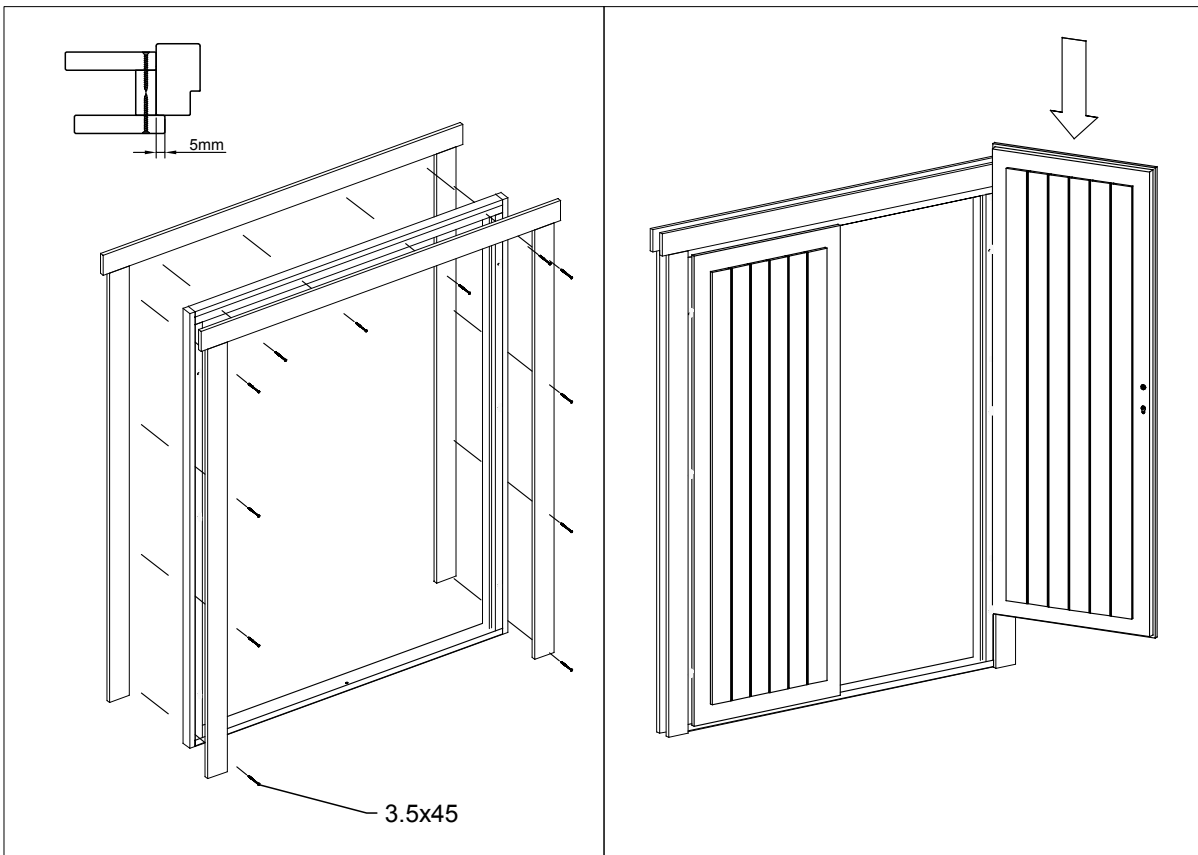

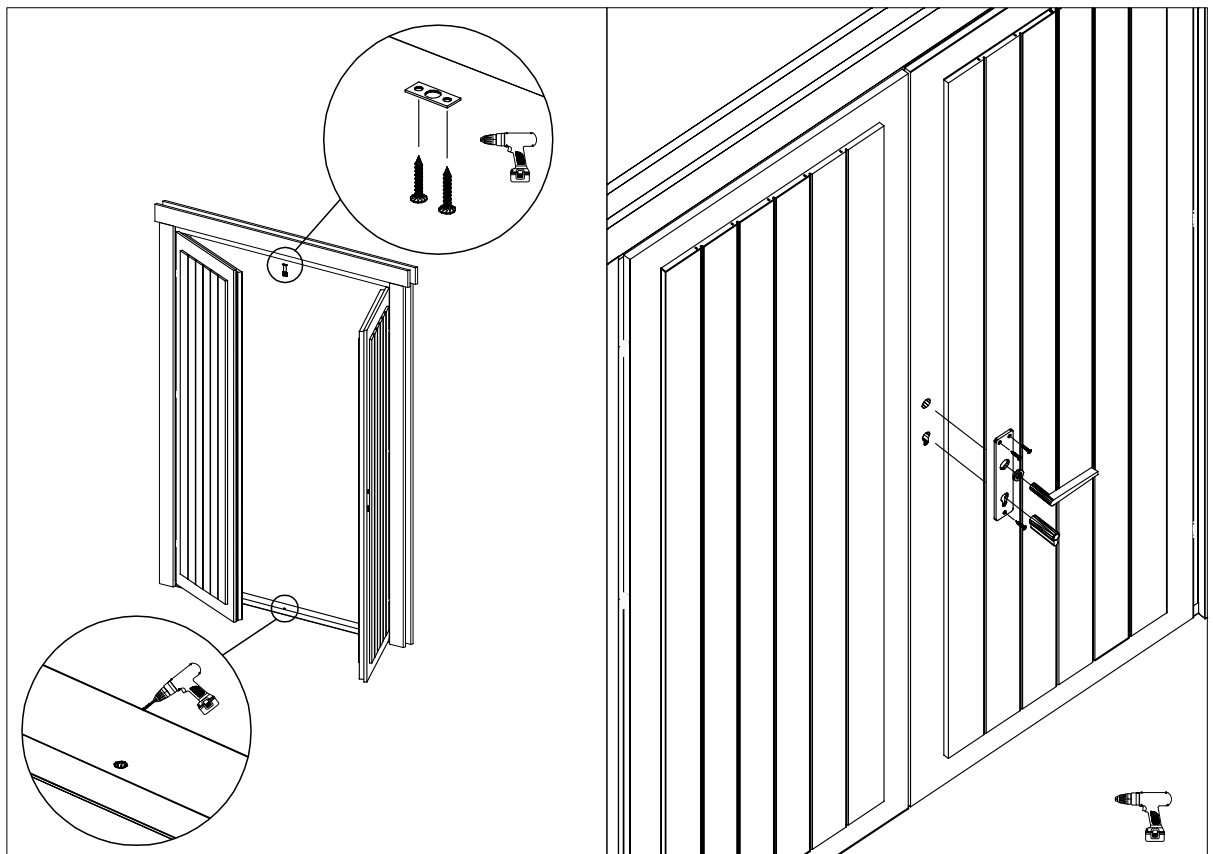

1

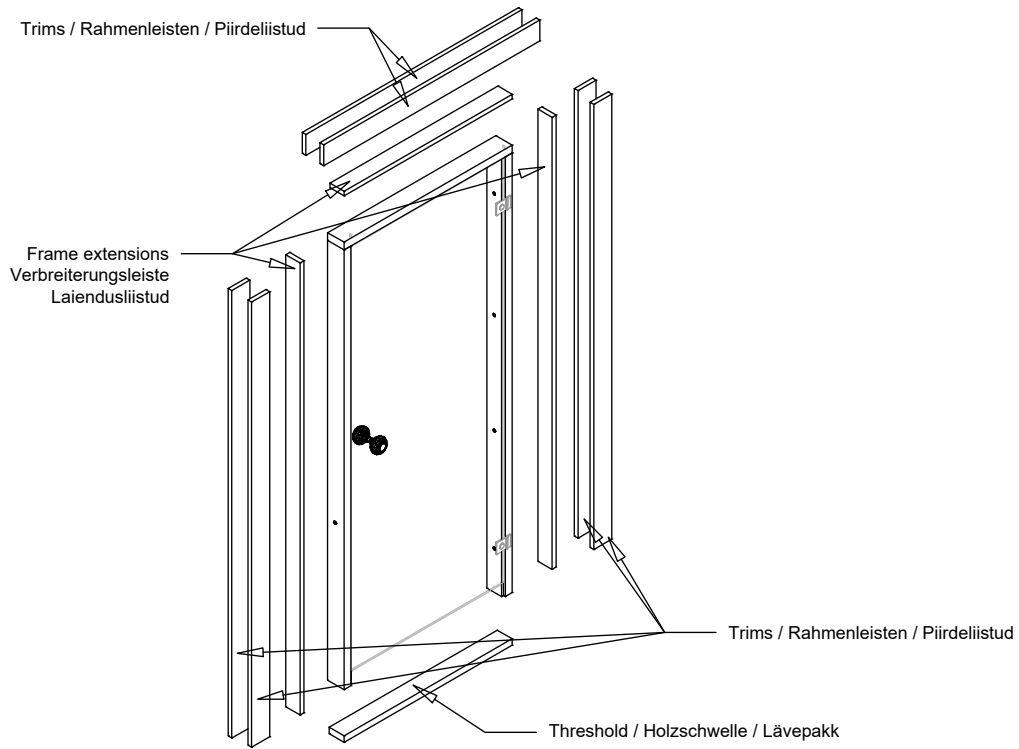

2

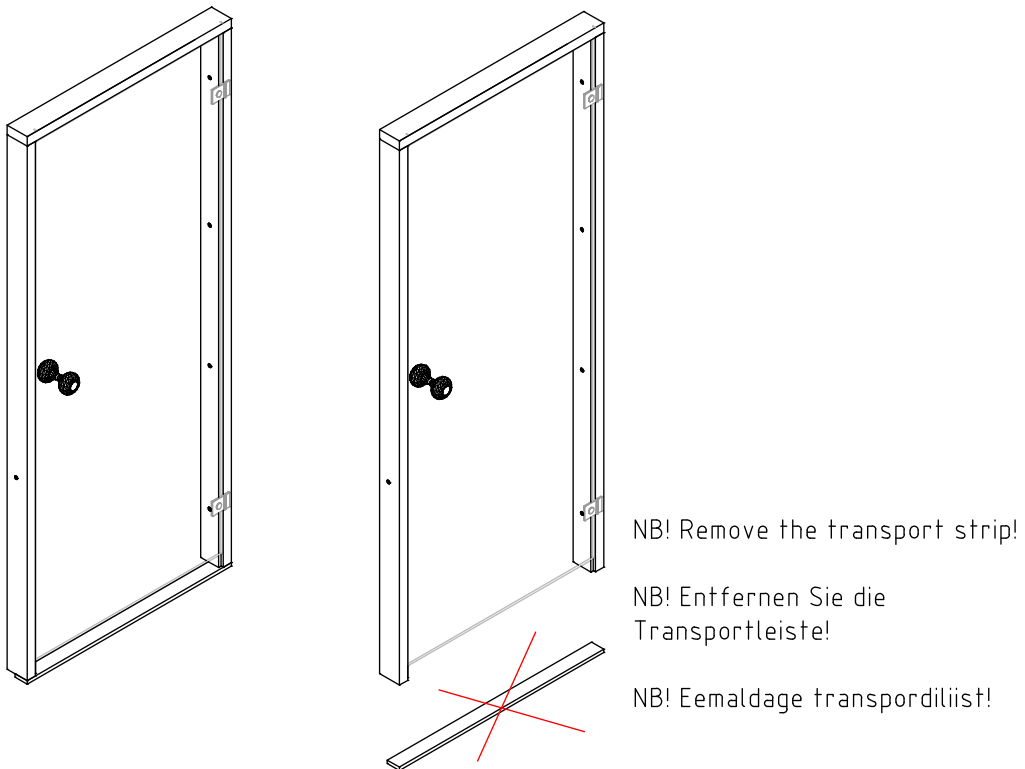

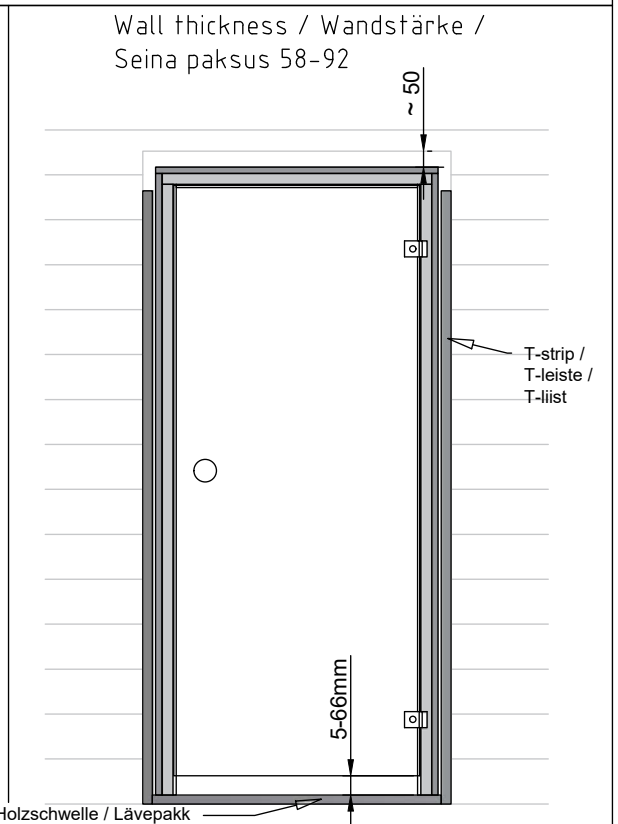
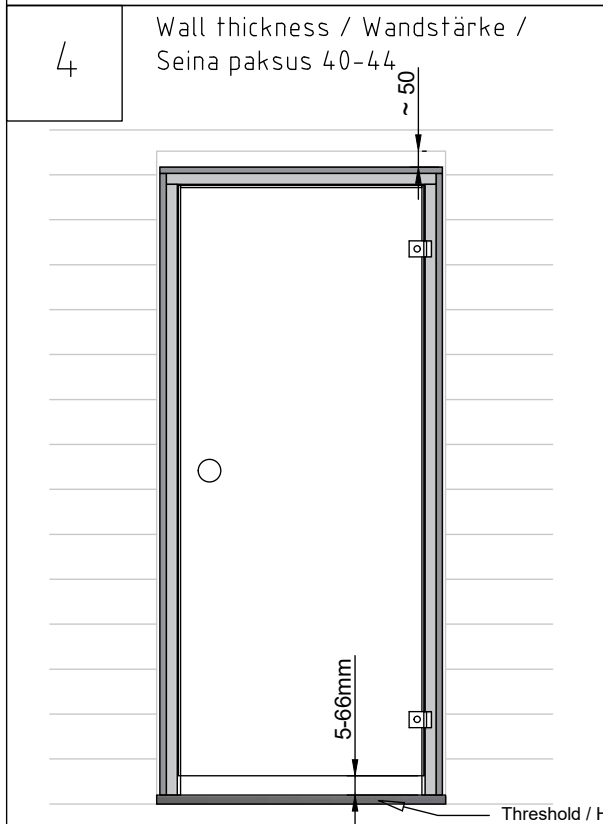
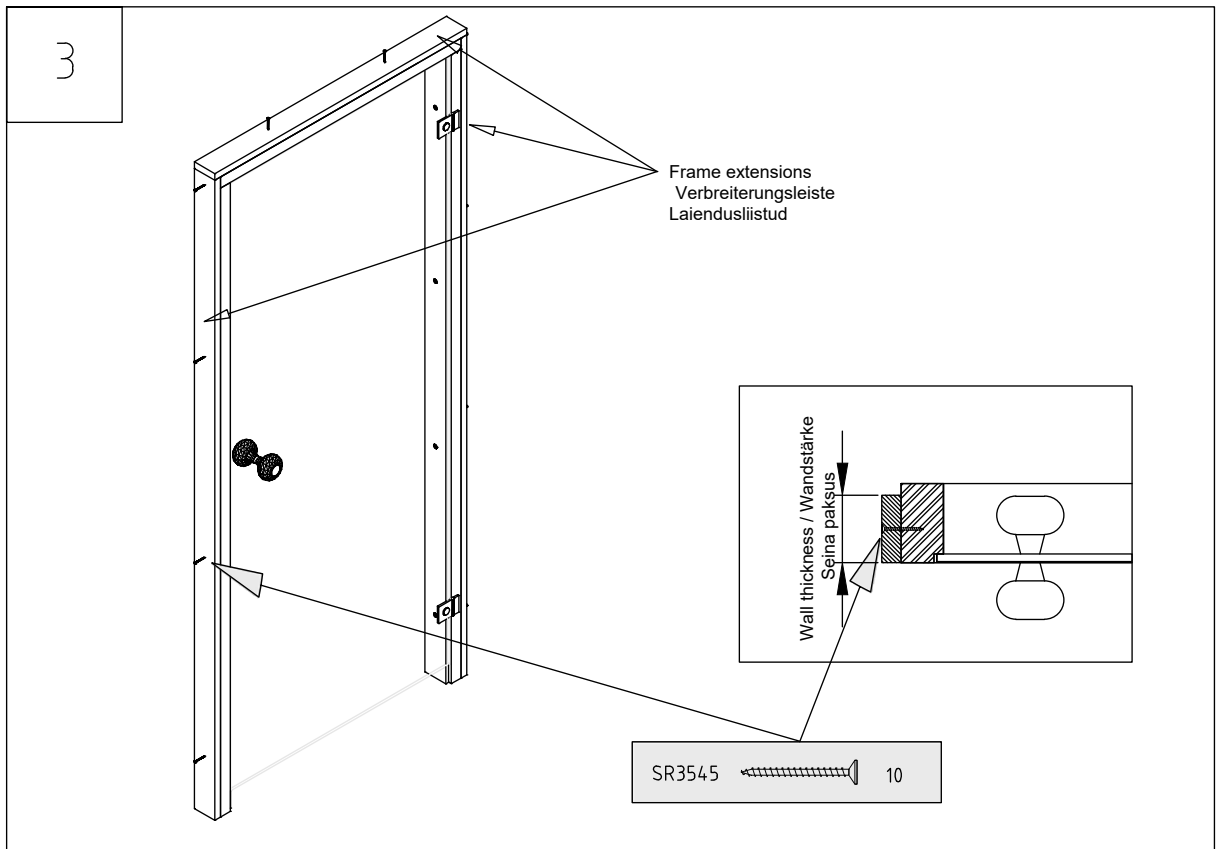



5

Wall thickness / Wandstärke / Seinä paksus 40-44

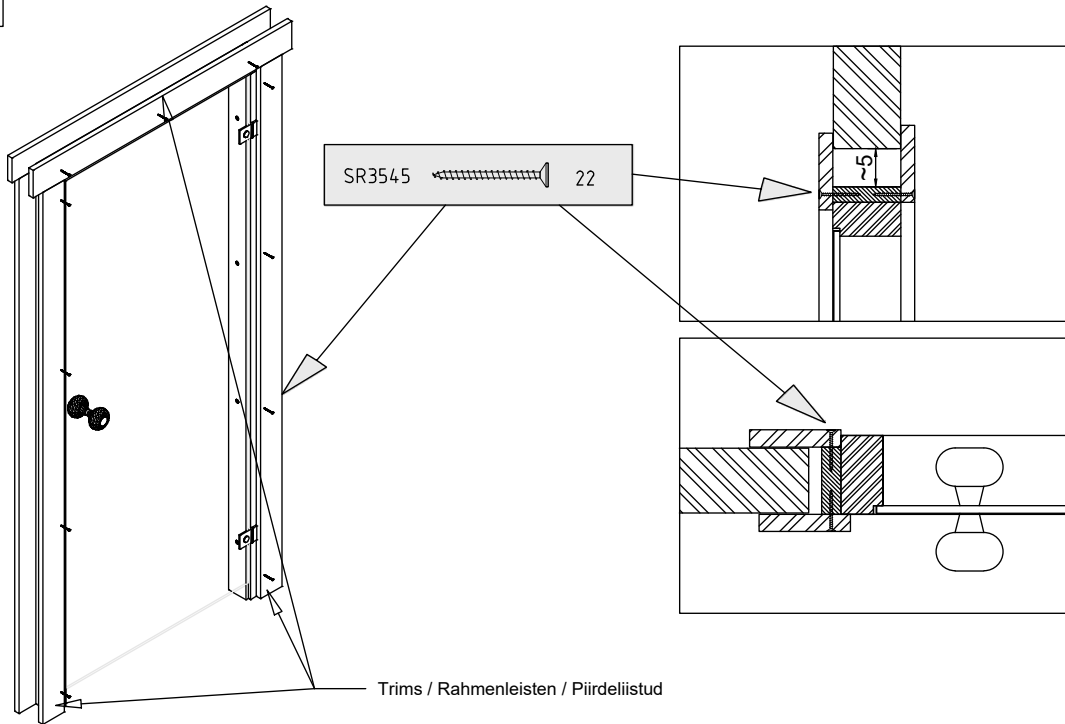

5

Wall thickness / Wandstärke / Seinä paksus 58-92

