

Technische Daten

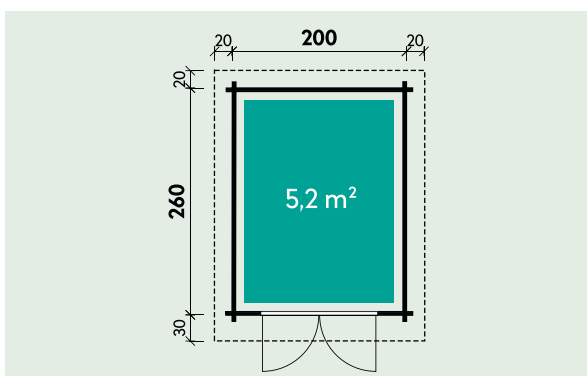

Artikelnummer:

528 065



Kontrolliert durch:

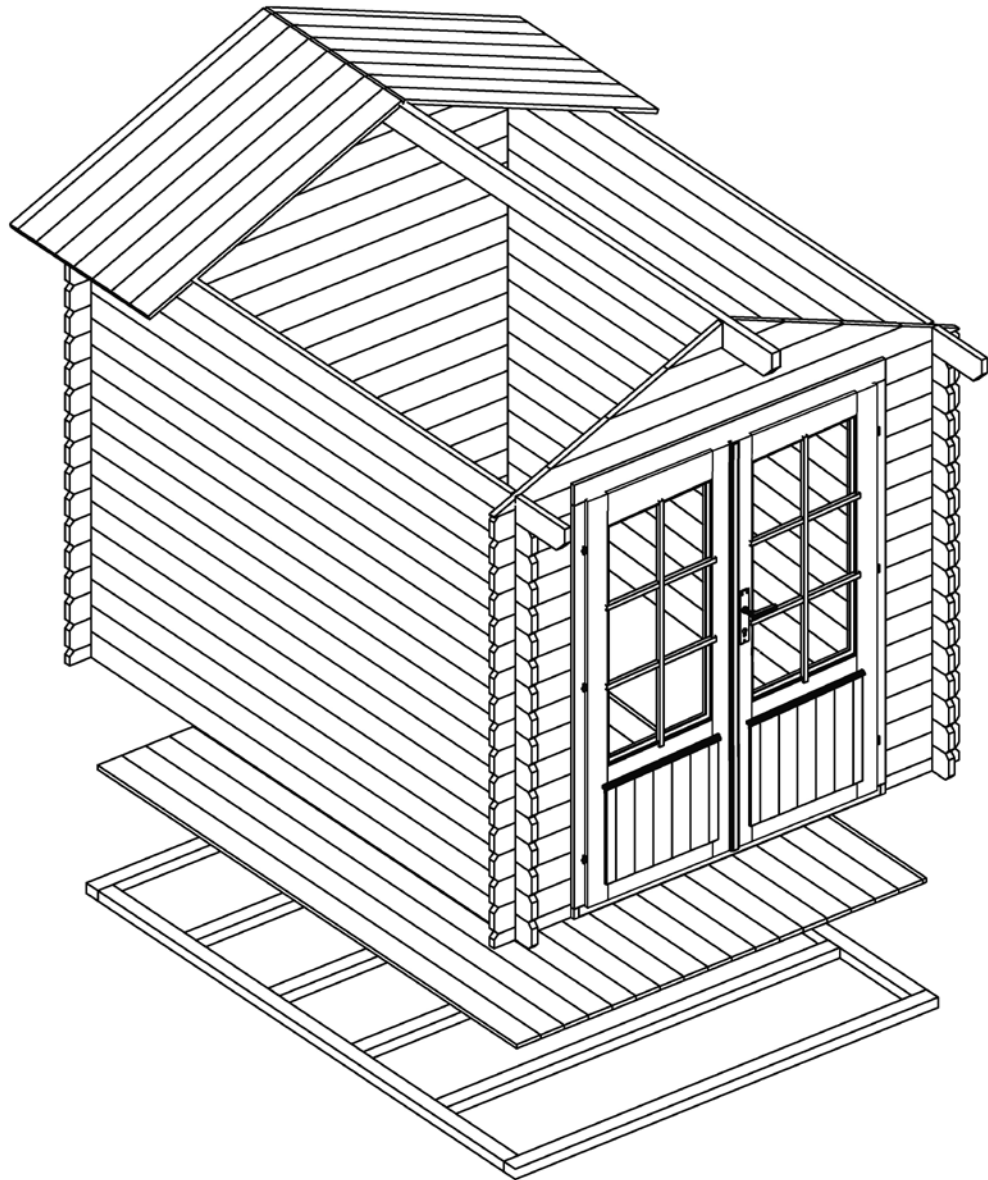

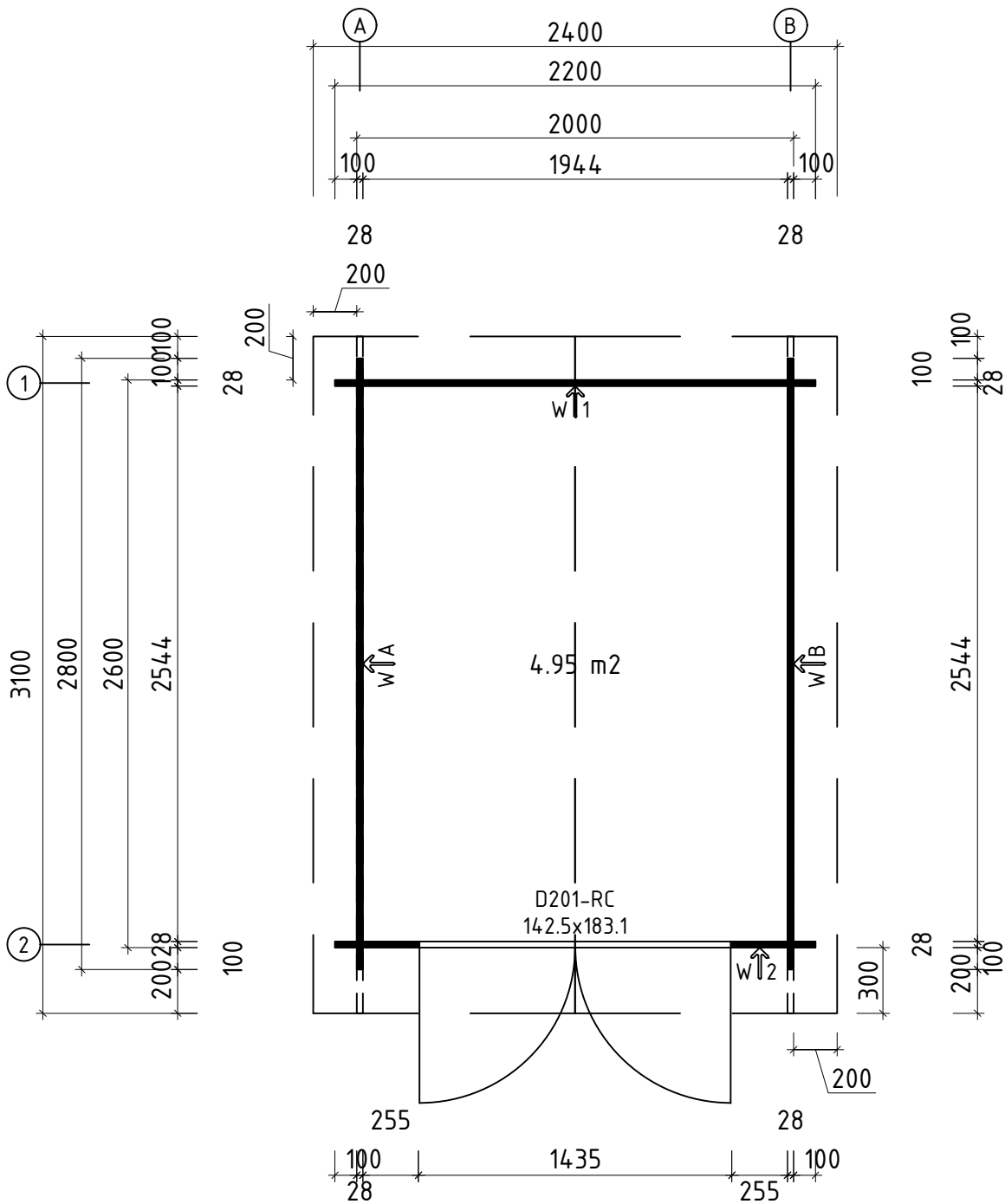



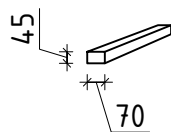
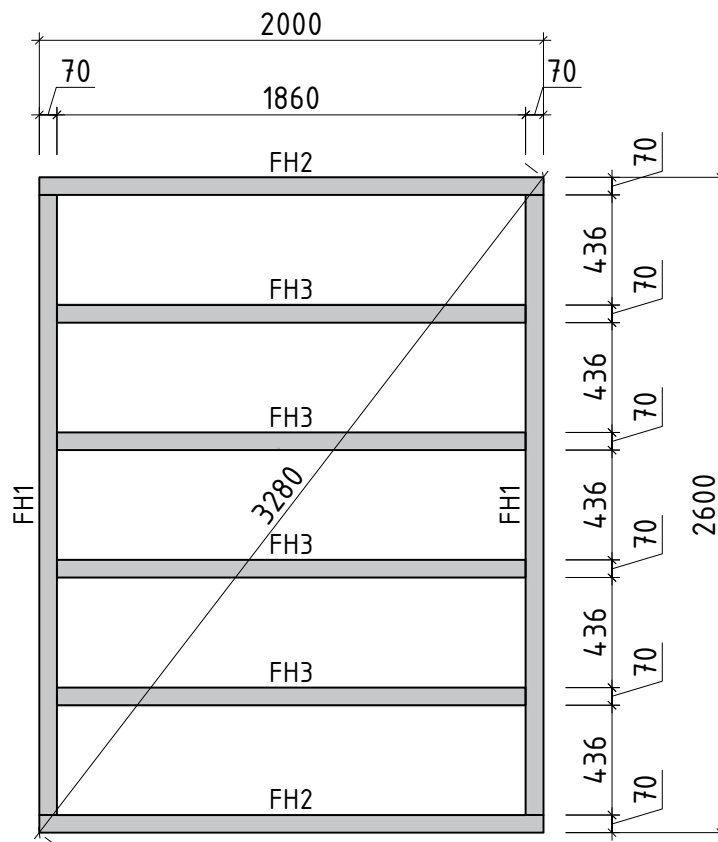





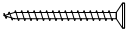
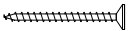
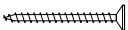
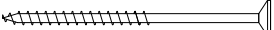
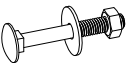

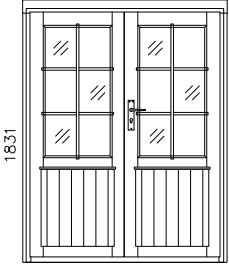
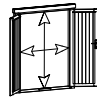

Wir empfehlen als Fundament für Ihr Gartenhaus eine vollflächig festgegründete, gepflasterte oder betonierte Fläche. Wahlweise ist auch ein Punkt- oder Streifenfundament möglich.

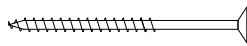

Nr.		Stck	Profil (mm)	Länge (mm)
001		1	28x114	3100
002		1	28x114	3100
003		32	28x114	2800
005		1	28x57	2200
006		16	28x114	2200
009		32	28x114	383
010		2	28x57	383
W1-1		1		
W2-1		1		
FH1	FUNDAMENTHÖLZER (imprägniert) 	2	70x45	2460
FH2	FUNDAMENTHÖLZER (imprägniert) 	2	70x45	2000
FH3	FUNDAMENTHÖLZER (imprägniert) 	4	70x45	1860
PF1	PFETTEN 	1	40x120	3100
	DACHBRETTER	56+1	113x18	1295
	FUSSBODENBRETTER	18+1	113x18	2540
	FUSSBODENLEISTEN		18x40	10.0lfm
G02-1	GIEBELBRETTER 18x120	4	18x120	1375
G06-1	GIEBELDECKLEISTEN 18x58	4	18x58	1375
T01-1	TRAUFBRETTER 18x95	2	18x95	3100
T06-1	TRAUFBREITEN 18x40	2	18x40	3100
SM-1	Sturmleisten	4	18x40	1825
GS	Giebelsegment	2		
SH	Schlaghölzer	3		

Nr.			Stck	Profil (mm)	Länge (mm)
NG2 550	NÄGEL 2.5x50	Dachbretter		224	
NG2 550	NÄGEL 2.5x50	Fussbodenbretter		216	
SR3 030	SCHRAUBEN 3.0x30	Fussbodenleisten		18	
SR3 030	SCHRAUBEN 3.0x30	Traufenleisten		16	
SR3 545	SCHRAUBEN 3.5x45	Giebelbretter		16	
SR3 545	SCHRAUBEN 3.5x45	Giebeldeckleisten		16	
SR3 545	SCHRAUBEN 3.5x45	Giebelsegment		4	
SR3 545	SCHRAUBEN 3.5x45	Traufenbretter		16	
SR5 0100	SCHRAUBEN 5.0x100	Fundamenthölzer		32	
SS013	Schloßschrauben M8x60 Mutter M8 U-Scheibe Ø25 - Befestigung für Sturmleisten			12	
	✓ - bitte selber anpassen (falls nötig!)				

Nr.		Stck	Profil (mm)	Länge (mm)
	<p style="text-align: center;">TÜR 1425x1831 D2-D28R-56C-14251831</p> <p>Q2 D201-RC 1425</p>  <div style="display: flex; justify-content: space-between; margin-top: 10px;"> <div style="border: 1px solid black; border-radius: 10px; padding: 5px; width: 45%;"> <p>Right handed / DIN rechts / paremakäeline</p> </div> <div style="border: 1px solid black; border-radius: 10px; padding: 5px; width: 45%;"> <p>Clear opening/ durchgangsmaß/ ava suurus</p> <p>1337x1743mm</p>  </div> </div> <div style="display: flex; justify-content: space-between; margin-top: 10px;"> <div style="border: 1px solid black; border-radius: 10px; padding: 5px; width: 45%;"> <p>Clear float glass klares Floatglas kirkas klaas</p> <p>492x950mm</p> </div> <div style="border: 1px solid black; border-radius: 10px; padding: 5px; width: 45%;">  </div> </div>	1		
PROSS H1-1	Q2-Q3-1 Muntins - Sprossen - Prossid horizontal 18x18 	4	18x18	517
PROSS V2-1	Q2-Q3-2 Muntins - Sprossen - Prossid vertical 18x18 	2	18x18	975
SR25 15-01	2.5x15 Locking plate - Schließblech - Riivi vastus 01 Q2-Q3 	2		
SR30 22-01	3.0x20ÜP Muntins - Sprossen - Prossid 	12		
SR50 90-01	5.0x90 Door frames - Türrahmen - Ukselengid 	8		
RV01	Locking plate - Schließblech - Riivi vastus 01 Q2-Q3 	1		
UL-Q 2-Q3	Q2-Q3 Door handle - Türgriff - Ukselink 	1		
LS-Q4	Q4 Cylinder lock - Zylinderschloss - Lukusüdamik 	1		

