

# Technische Daten



Spiegelverkehrte Montage möglich.

## Artikelnummer:

536 130

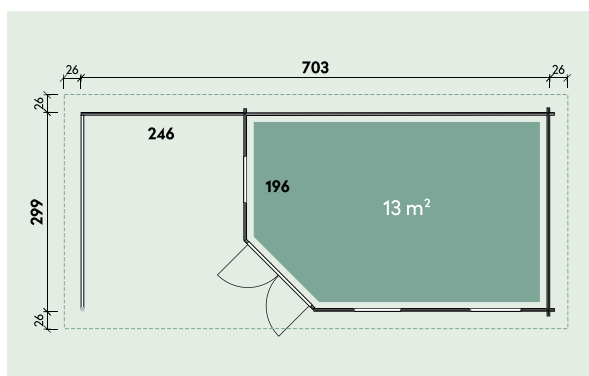

Kontrolliert durch:

Das Haus läßt sich auch spiegeverkehrt aufbauen. Darum ist es erforderlich, die Fußbodenbretter und Terrassenbretter im Eingangsbereich laut beigefügter Zeichnung selbst zuzuschneiden.

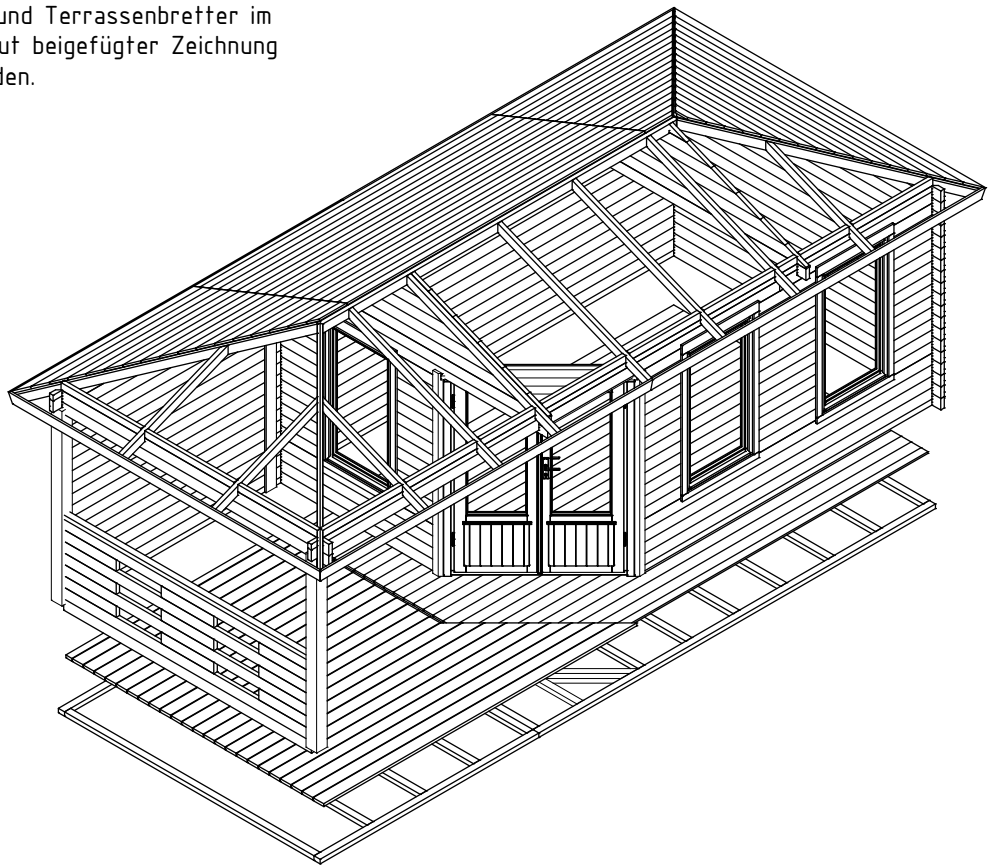

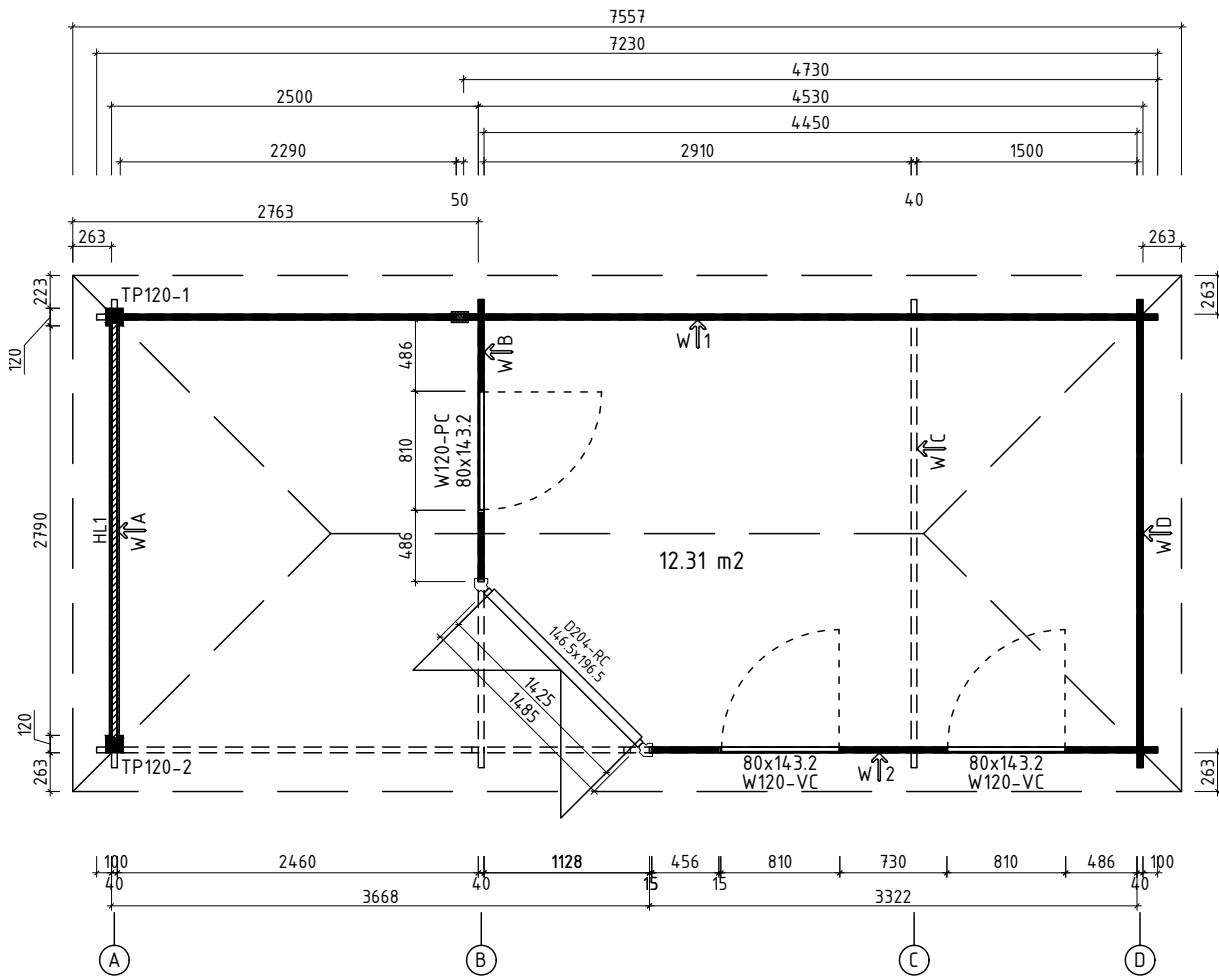





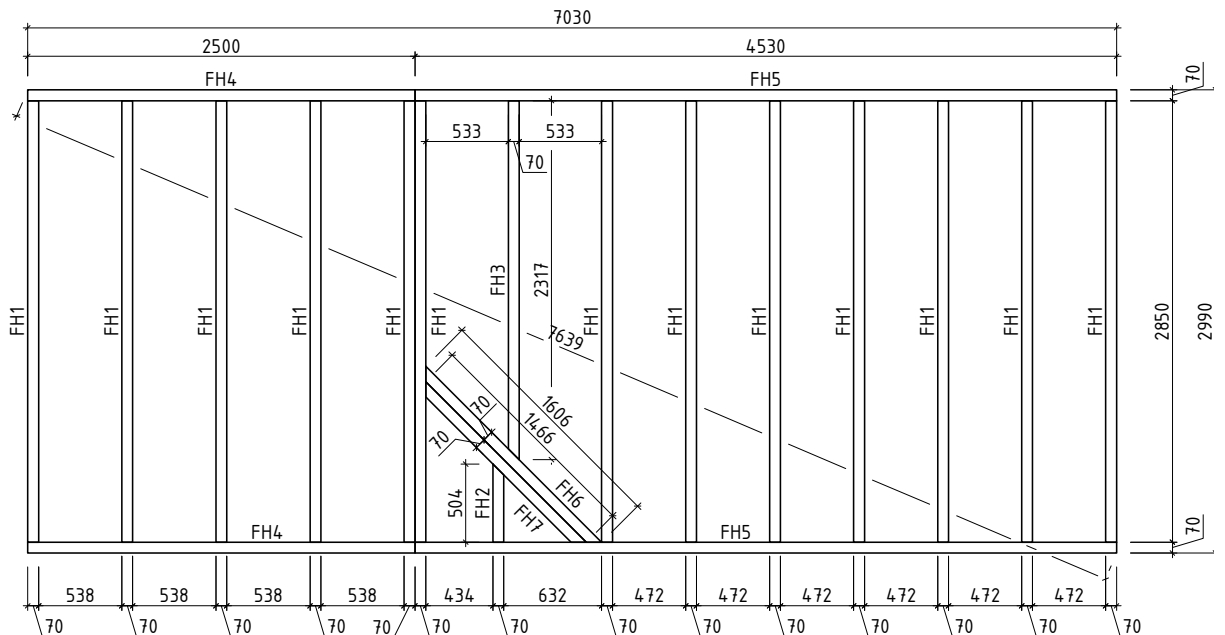



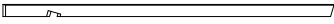
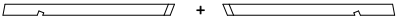
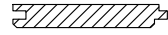
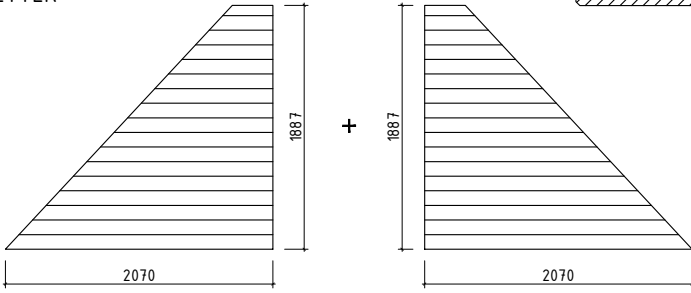
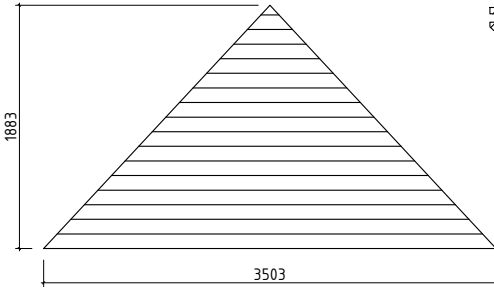

**Q2** – Qualitätsklasse für Fenster und Türen  
 \*Fenster und Türen sind ohne Sprossen

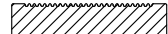

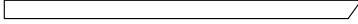







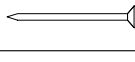
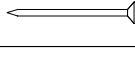
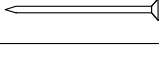

**Wir empfehlen als Fundament für Ihr Gartenhaus eine vollflächig festgegründete, gepflasterte oder betonierte Fläche. Wahlweise ist auch ein Punkt- oder Streifenfundament möglich.**

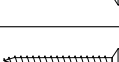

Nr.		Stck	Profil (mm)	Länge (mm)
001		1	40x114	5790
002		1	40x57	5570
003		1	40x57	5570
004		1	40x114	5350
005		1	40x114	4730
006		16	40x114	4730
007		1	40x57	4730
008		1	40x114	3462
009		3	40x114	3462
010		1	40x57	3462
012		2	40x114	3190
013		20	40x114	3190
014		1	40x114	3190
015		1	40x114	3190
016		5	40x114	2830
018		17	40x114	2290
019		1	40x57	2290
021		4	40x114	1922
022		1	40x114	1880
023		1	40x57	1660
024		1	40x57	1660
026		1	40x114	1440
027		2	40x72	1020
029		2	40x72	953
030	Draufsicht	✓ 4+4	40x72	910

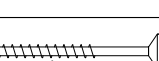
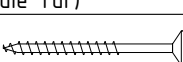
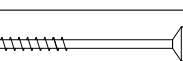
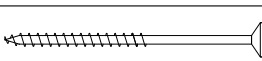
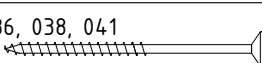
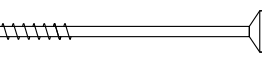

Nr.		Stck	Profil (mm)	Länge (mm)
031		6	40x72	807
032		10	40x114	730
033		2	40x114	730
034		1	40x114	730
035		26	40x114	626
036		2	40x72	620
037		9	40x114	600
038		2	40x72	555
039		26	40x114	456
040		2	40x72	212
WB-1		1		
WC-1		1		
FH5	FUNDAMENTHÖLZER (imprägniert) 	2	70x45	4530
FH1	FUNDAMENTHÖLZER (imprägniert) 	13	70x45	2850
FH4	FUNDAMENTHÖLZER (imprägniert) 	2	70x45	2500
FH3	FUNDAMENTHÖLZER (imprägniert) 	1	70x45	2317
FH6	FUNDAMENTHÖLZER (imprägniert) 	1	70x45	1606
FH7	FUNDAMENTHÖLZER (imprägniert) 	1	70x45	1466
FH2	FUNDAMENTHÖLZER (imprägniert) 	1	70x45	504
HL1	HANDLAUF 	1	65x44	2830
LE1	LEISTE 	4	15x40	1472
SPR1	SPARREN 	10	44x85	1879
FPP1	FIRSTPFETTEN 	1	62x105	4102







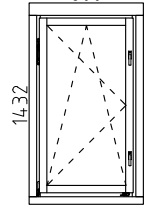
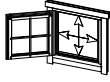



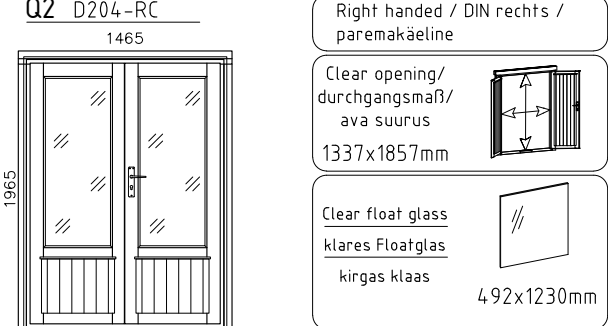



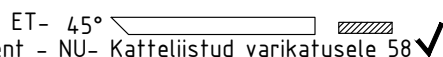

Nr.		Stck	Profil (mm)	Länge (mm)
GSP1	GRATSPARREN 	4	44x94	2564
SFT1	SCHIFTER 	4+4	44x85	1329
	DACHBRETTER 	34+1	113x18	3403
	DACHBRETTER 	2+2	113x18	
	DACHBRETTER 	2	113x18	
	FUSSBODENBRETTER 	26+1	113x18	4445
	TERRASSENBRETTER (imprägniert)  ✓	9+1	120x28	3578-2578
	TERRASSENBRETTER (imprägniert) 	15	120x28	2455
	FUSSBODENLEISTEN  ✓		18x40	15,0 lfdm
A40-1	ADAPTER 40 Obere Seite  ✓	1	120x76	2110
T02-1	TRAUFENBRETTER 18x120  ✓	2	18x120	3615
T02-2	TRAUFENBRETTER 18x120  ✓	2+2	18x120	3825
TP1 20-1	STÜTZPFOSTEN 120x120  ✓	1	120x120	1925
TP1 20-2	STÜTZPFOSTEN 120x120  ✓	1	120x120	1925
SM-1	Sturmleisten 	4	18x40	2050
ML1	Metallstange 	2	D10	870
ML2	Metallstange 	6	D10	240

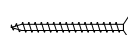
Nr.			Stck	Profil (mm)	Länge (mm)
SH	Schlaghölzer		3		
HK1	HOLZ-KLOTZEN für verbinden der Wandbohlen (104mm)		2		
VS	VERBINDUNGSSTREIFEN für verbinden der Wandbohlen		2		
NG2 550	NÄGEL 2.5x50 Dachbretter		1072		
NG2 550	NÄGEL 2.5x50 Fussbodenbretter		468		
NG2 560	NÄGEL 2.5x60 Terrassenbretter		288		
SR3 030	SCHRAUBEN 3.0x30 Fussbodenleisten		30		
SR3 545	SCHRAUBEN 3.5x45 Handlauf		6		
SR3 545	SCHRAUBEN 3.5x45 Leiste LE1		52		
SR3 545	SCHRAUBEN 3.5x45 Traufenbretter		56		
SR354 5-001	SCHRAUBEN 3.5x45 Verbindungsstreifen		8		
SR4 060	SCHRAUBEN 4.0x60 Stützpfoste		8		
SR55	SCHRAUBEN 5.0x70 SPR1, GSP1, SFT1 Pos 010 und 021 (1. Bohlenreihe neben die Tür)		26		
SR5 070	SCHRAUBEN 5.0x70 Stützpfoste		12		
SR57	SCHRAUBEN 5.0x100 SPR1, GSP1, SFT1		22		
SR5 0100	SCHRAUBEN 5.0x100 Fundamenthölzer		84		
SR5 0100	SCHRAUBEN 5.0x100 Pos 014, 027, 029, 030, 031, 036, 038, 041		50		
SR61	SCHRAUBEN 6.0x140 Pos 003		5		
SS024	Schloßschrauben M8x70 Mutter M8 U-Scheibe Ø25 - Befestigung für Sturmleisten		12		
VP2	Verstellbare Pfostenstütze M16		2		
	✓ - bitte selber anpassen (falls nötig)!				

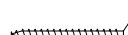



Nr.		Stck	Profil (mm)	Länge (mm)
	<p style="text-align: center;">FENSTER 800x1432 W2-S40V-0XC-08001432</p> <div style="display: flex; align-items: flex-start;"> <div style="margin-right: 20px;"> <p>Q2 W120-VC 800</p>  </div> <div style="border: 1px solid black; border-radius: 5px; padding: 5px; width: 180px;"> <p>Left handed/ DIN links vasakukäeline</p> </div> <div style="border: 1px solid black; border-radius: 5px; padding: 5px; width: 180px;"> <p>Clear opening/ durchgangsmaß/ ava suurus  686x1309mm</p> </div> <div style="border: 1px solid black; border-radius: 5px; padding: 5px; width: 180px;"> <p>Clear float glass klares Floatglas kirgas klaas  629x1251mm</p> </div> </div>	2		
AL-Q 2-Q3	Q2-Q3 Window handle - Fenstergriff - Aknalink 	4		

Nr.		Stck	Profil (mm)	Länge (mm)		
	<p style="text-align: center;"><b>TÜR 1465x1965</b> <b>D2-M40R-7XC-14651965</b></p> <p><b>Q2 D204-RC</b> 1465</p>  <p>Right handed / DIN rechts / paremakäeline</p> <p>Clear opening/ durchgangsmaß/ ava suurus 1337x1857mm</p> <p>Clear float glass klares Floatglas kirgas klaas 492x1230mm</p>	1				
DzT40-01-1	CD- cover strip for door - ET- Deckbrett zum Tür - NU- Katteliist ukse kohale 40		1	18x40	1585	
P9L1-01-1	CD- left hand doorpost - ET- linke Türpfoste - NU- vasak uksepost 40		1	90x90	2005	
P9R1-01-1	CD- right hand doorpost - ET- rechte Türpfoste - NU- parem uksepost 40		1	90x90	2005	
VK1-01-1	CD- trim strips for canopy element - ET- Verkleidungsleisten für Vordachelement - NU- Katteliistud varikatusele 58		2	58x18	1110	
PL1-1	Trims - Rahmenleisten - Piirdeliistud 18x40		✓	1	18x40	1540
PL2-1	Trims - Rahmenleisten - Piirdeliistud 18x58		✓	4	18x58	1945
PL3-1	Trims - Rahmenleisten - Piirdeliistud 18x95		✓	1	18x95	1540
SR25-15-01	2.5x15 Locking plate - Schließblech - Riivi vastus 01 Q2-Q3		2			
SR35-45-05	3.5x45 Canopy element - Vordachelement - Varikatus		6			
SR35-45-03	3.5x45 Cover strip - Deckbrett - Katteliist ukse kohale		3			
SR35-45-04	3.5x45 Trim strips - Verkleidungsleiste - Katteliist varikatusele		6			
SR35-45-01	3.5x45 Trims - Rahmleisten - Piirdeliistud		24			
SR50-90-01	5.0x90 Door frames - Türrahmen - Ukselengid		8			
VE1-01	CD- canopy element - ET- Vordachelement - NU- Varikatus uksele 1435x745		1			
RV01	Locking plate - Schließblech - Riivi vastus 01 Q2-Q3		1			
UL-Q2-Q3	Q2-Q3 Door handle - Türgriff - Ukselink		1			
LS-Q4	Q4 Cylinder lock - Zylinderschloss - Lukusüdamik		1			

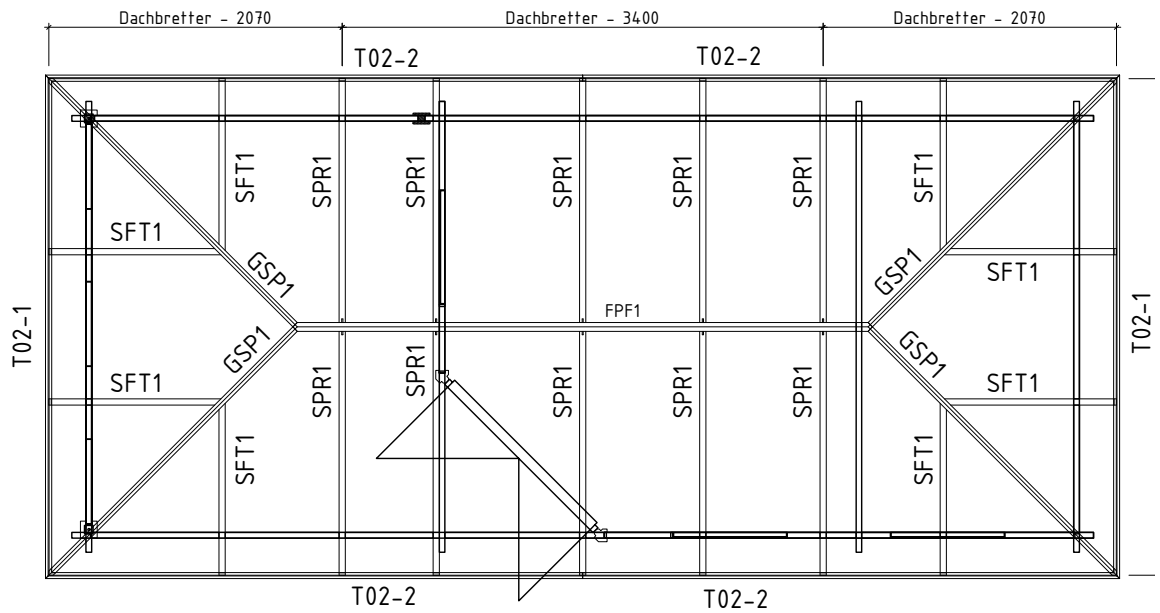

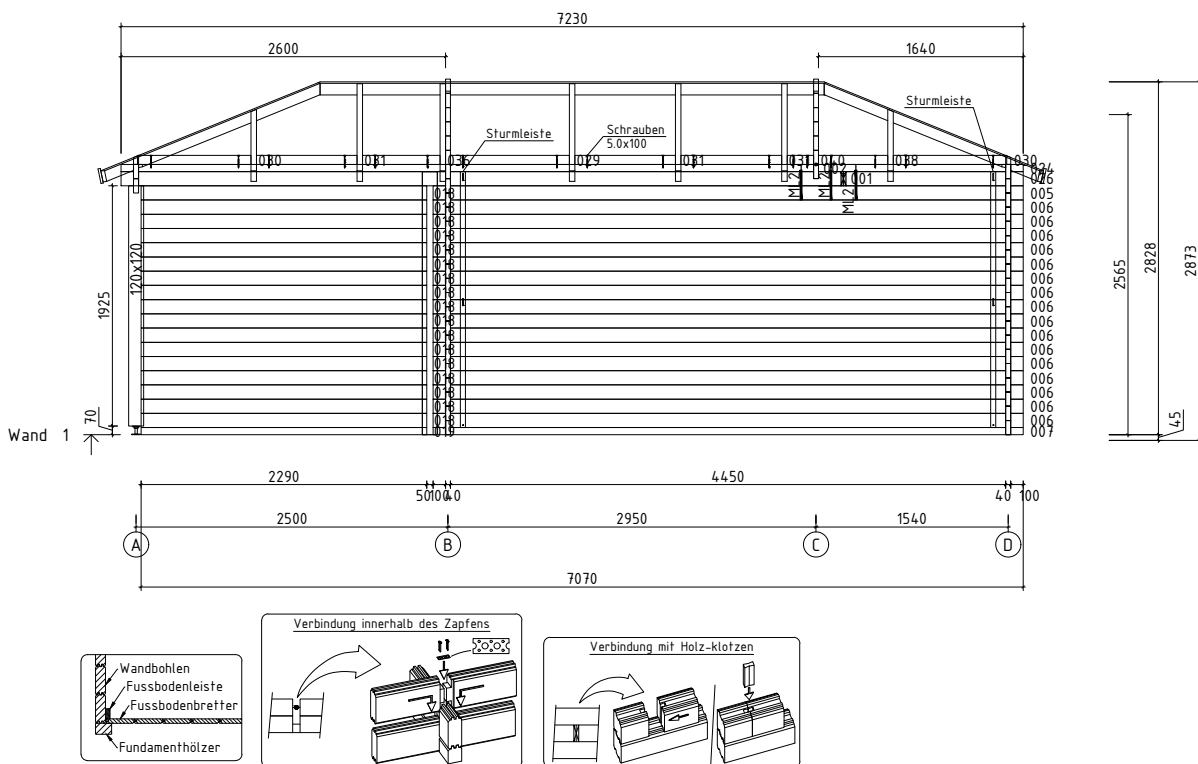

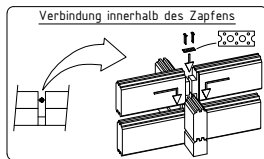
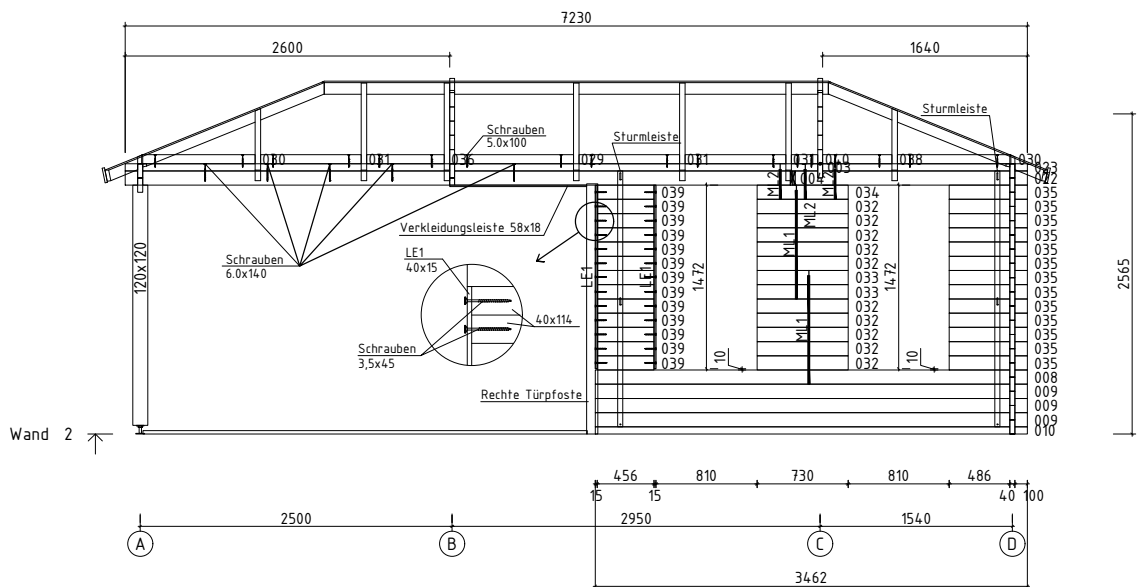

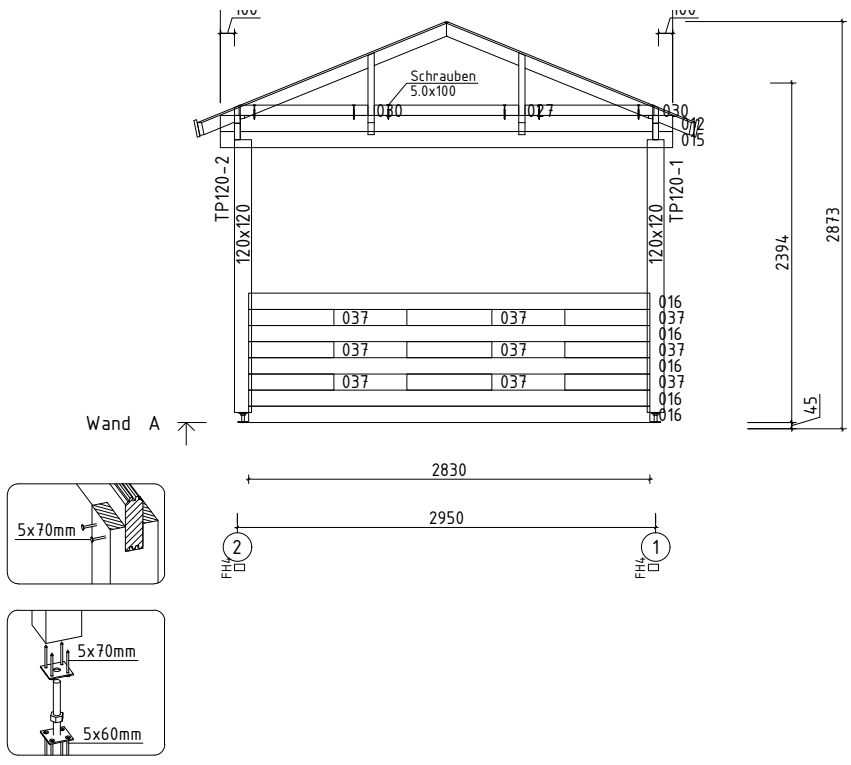

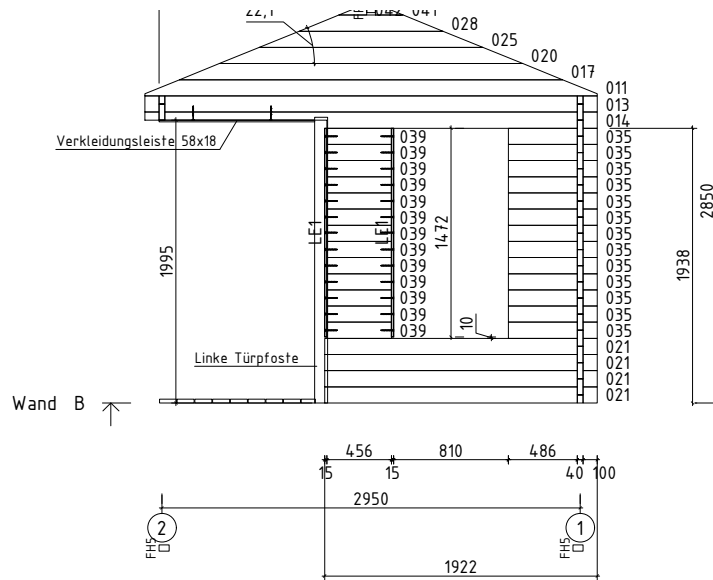



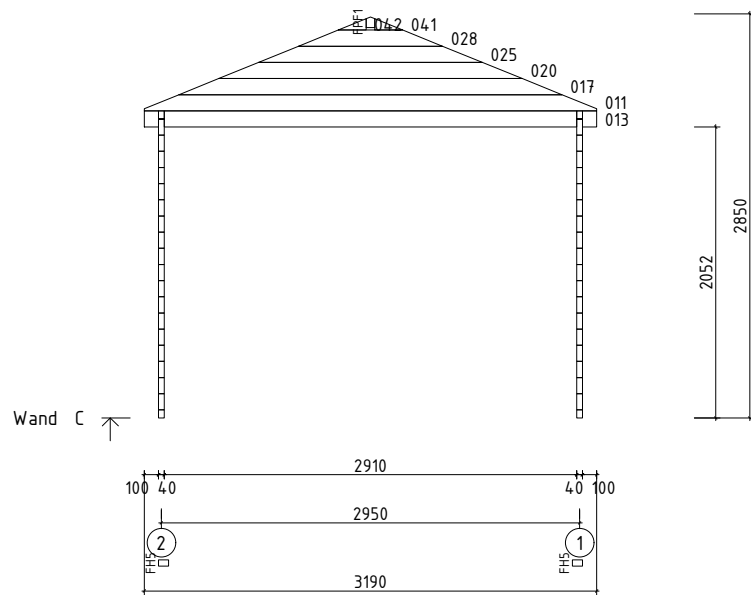

Tip wenn spiegelverkehrt.  
Tip for mirrored installation.

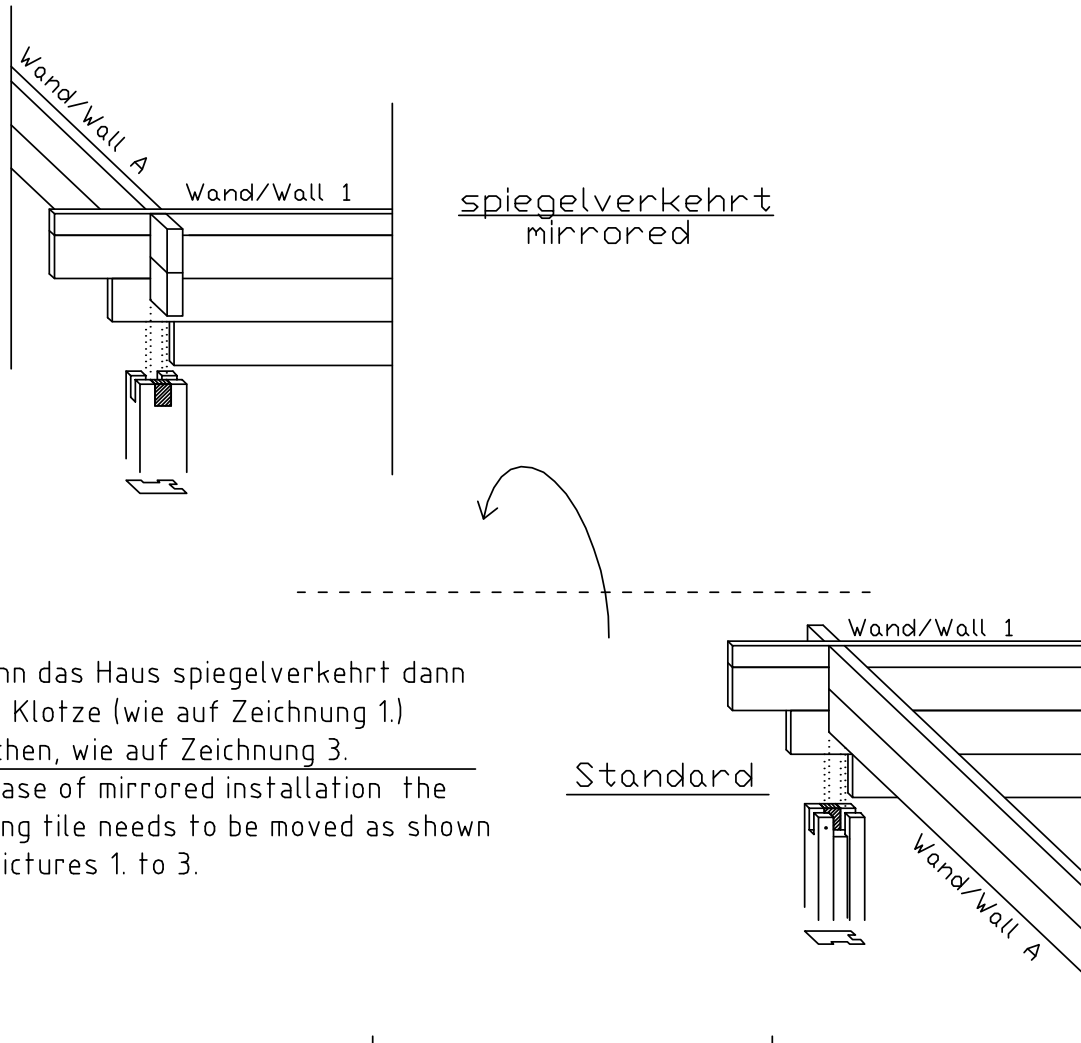

Wenn das Haus spiegelverkehrt dann das Klotze (wie auf Zeichnung 1.) machen, wie auf Zeichnung 3.

In case of mirrored installation the filling tile needs to be moved as shown in pictures 1. to 3.

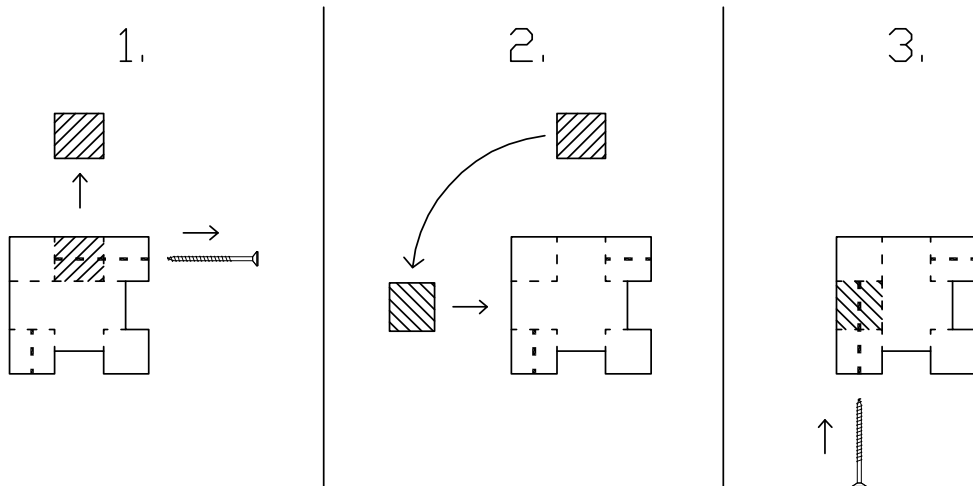

Step 1: Dachelement an den Wänden verschrauben.  
 Step 1: Screw canopy element to the wall.

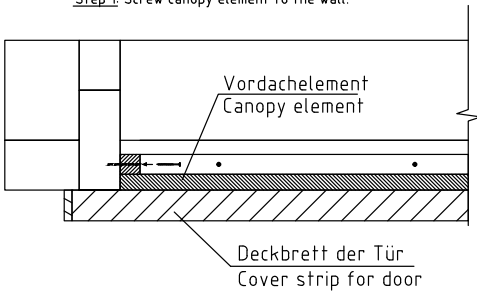

Step 3: Die Verkleidungsleisten in die richtige Länge schneiden und unter das VD-Element befestigen.  
 Step 3: Cut trim strips to size and fasten under the canopy element.

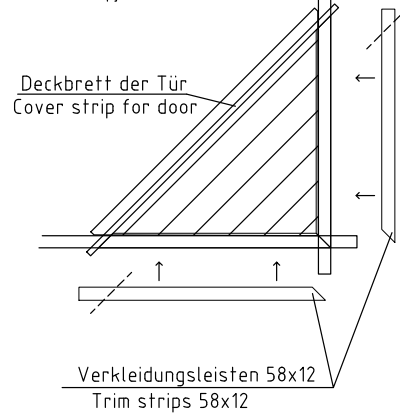

Step 2: Das Deckbrett muss von oben (durch das VD-Element) an das Dachelement verschraubt werden.  
 Step 2: Fasten cover strip to the canopy element.

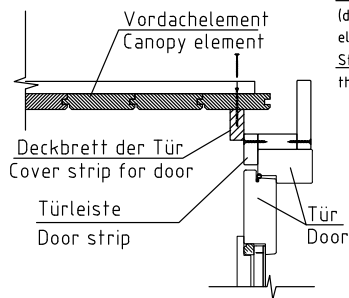

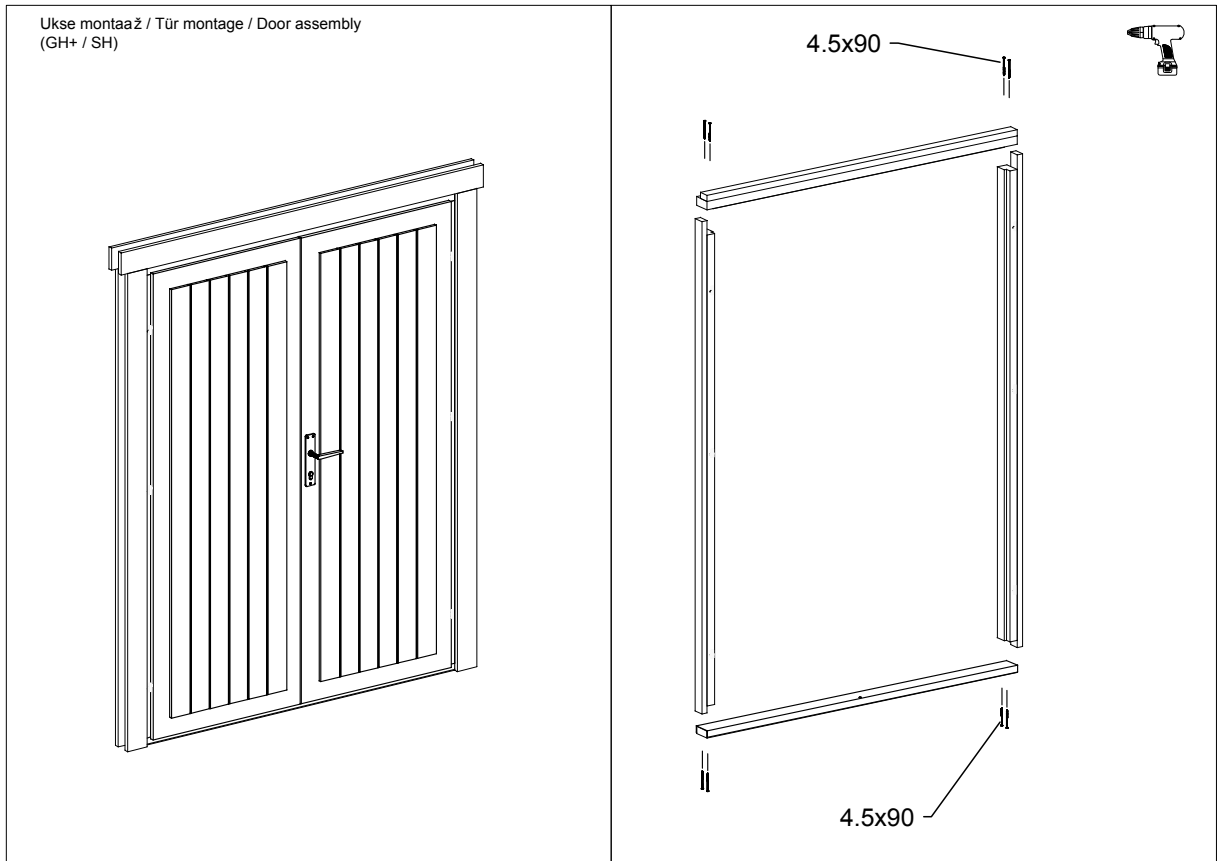

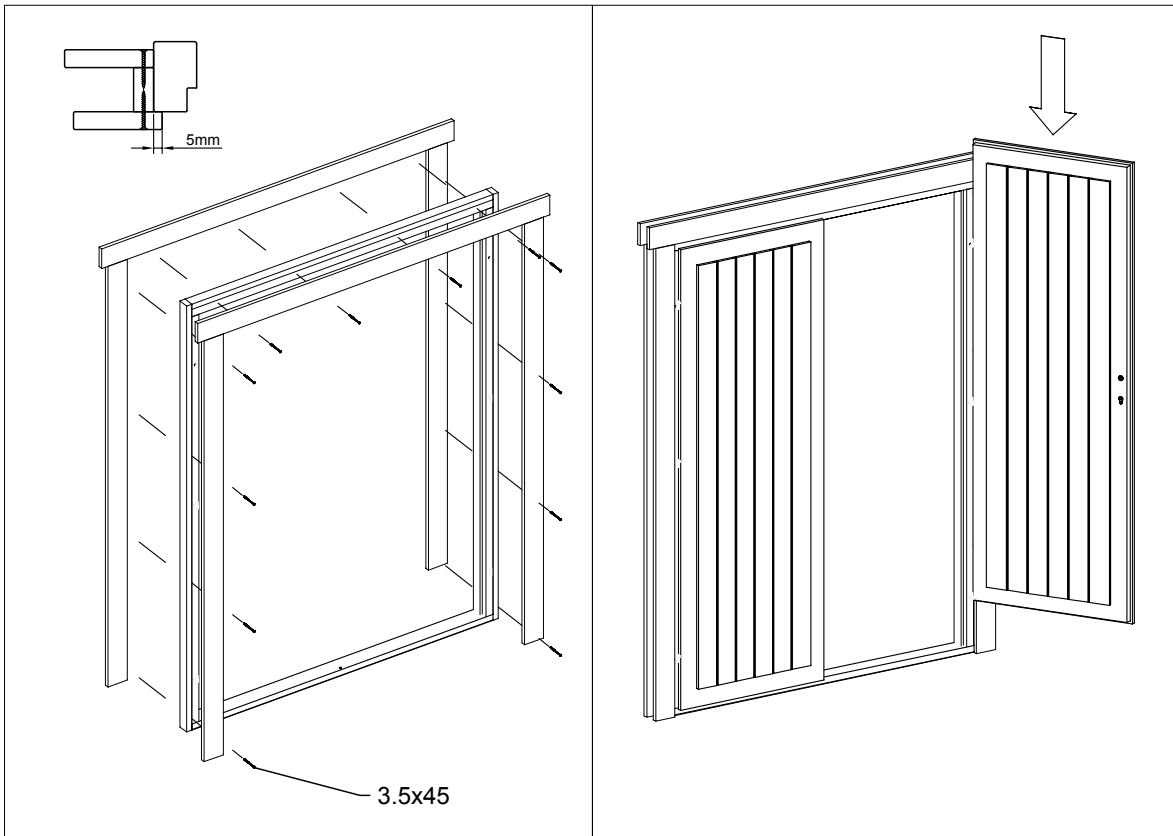

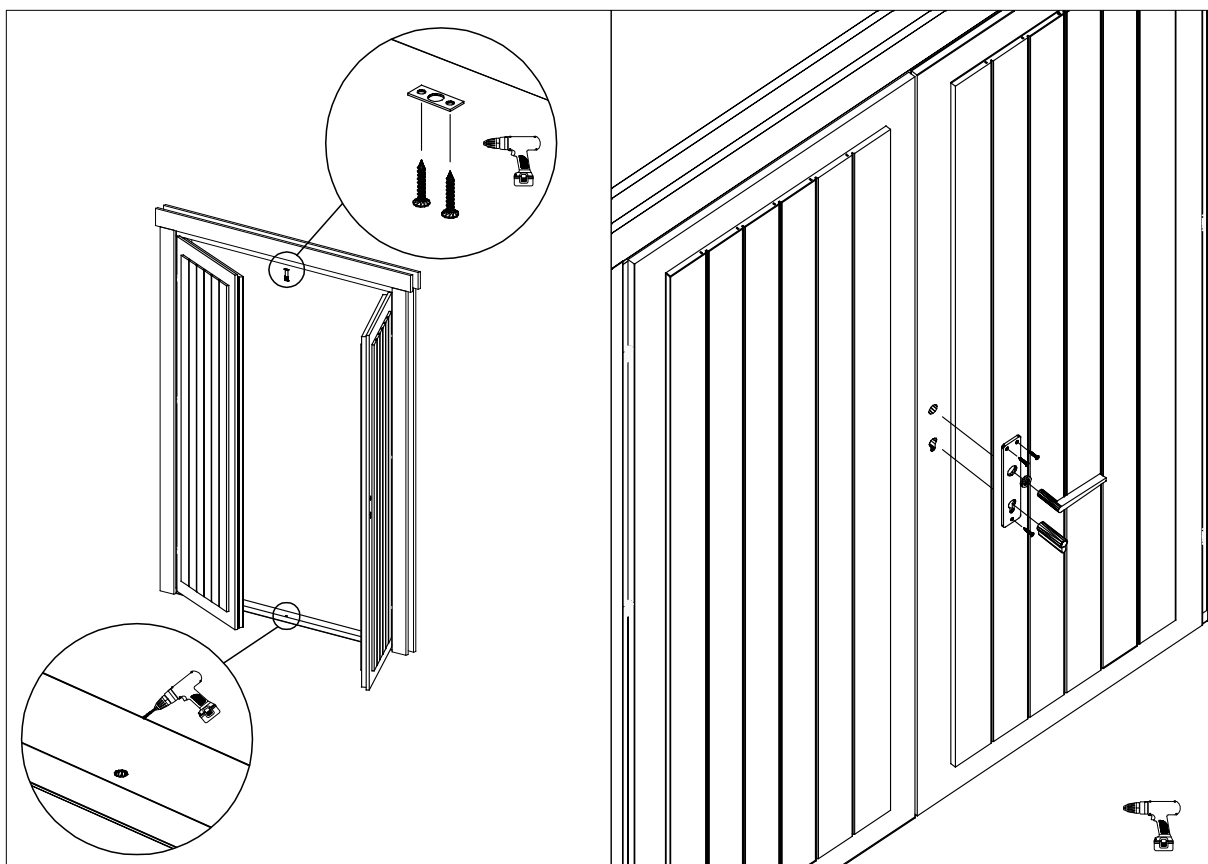

Zuschneiden der  
Fußbodenbretter 113x18mm

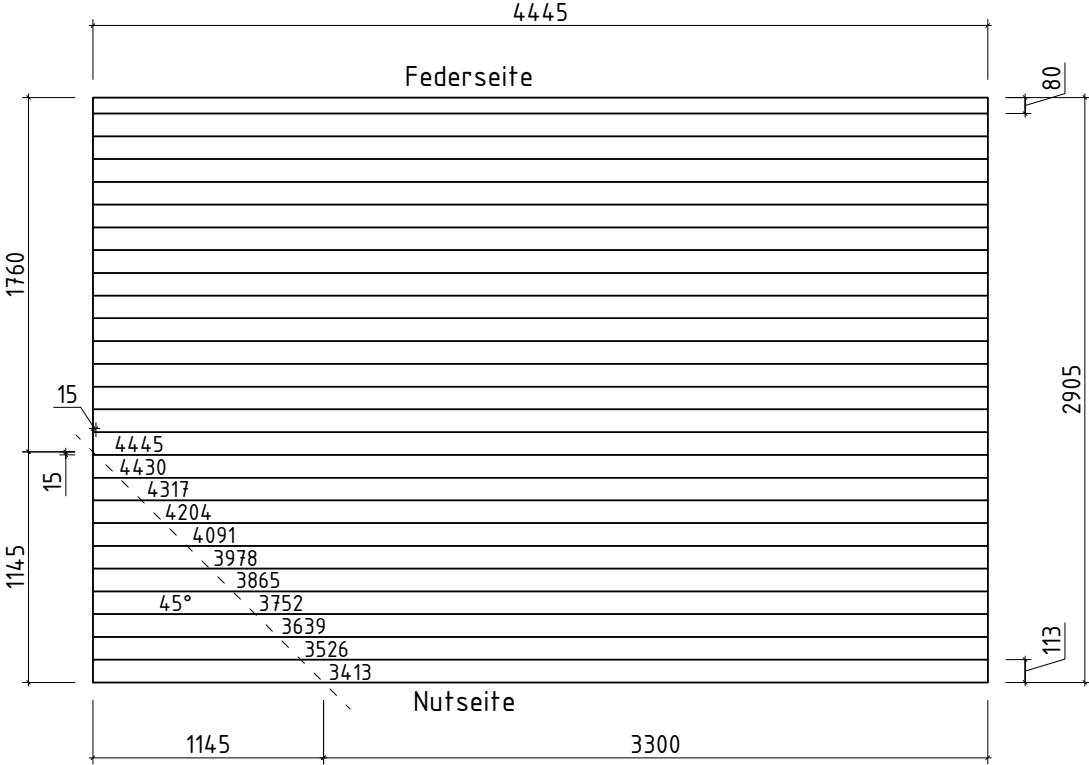

### Zuschneiden der Terrassenbretter 120x28mm

