

# Technische Daten



Spiegelverkehrte Montage möglich. Durch Kunden farblich behandelt.

## Artikelnummer:

228 330, 831 351, 831 352, 831 353, 831 354

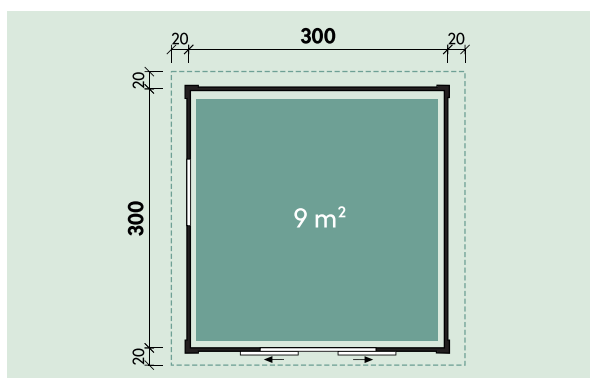

Kontrolliert durch:

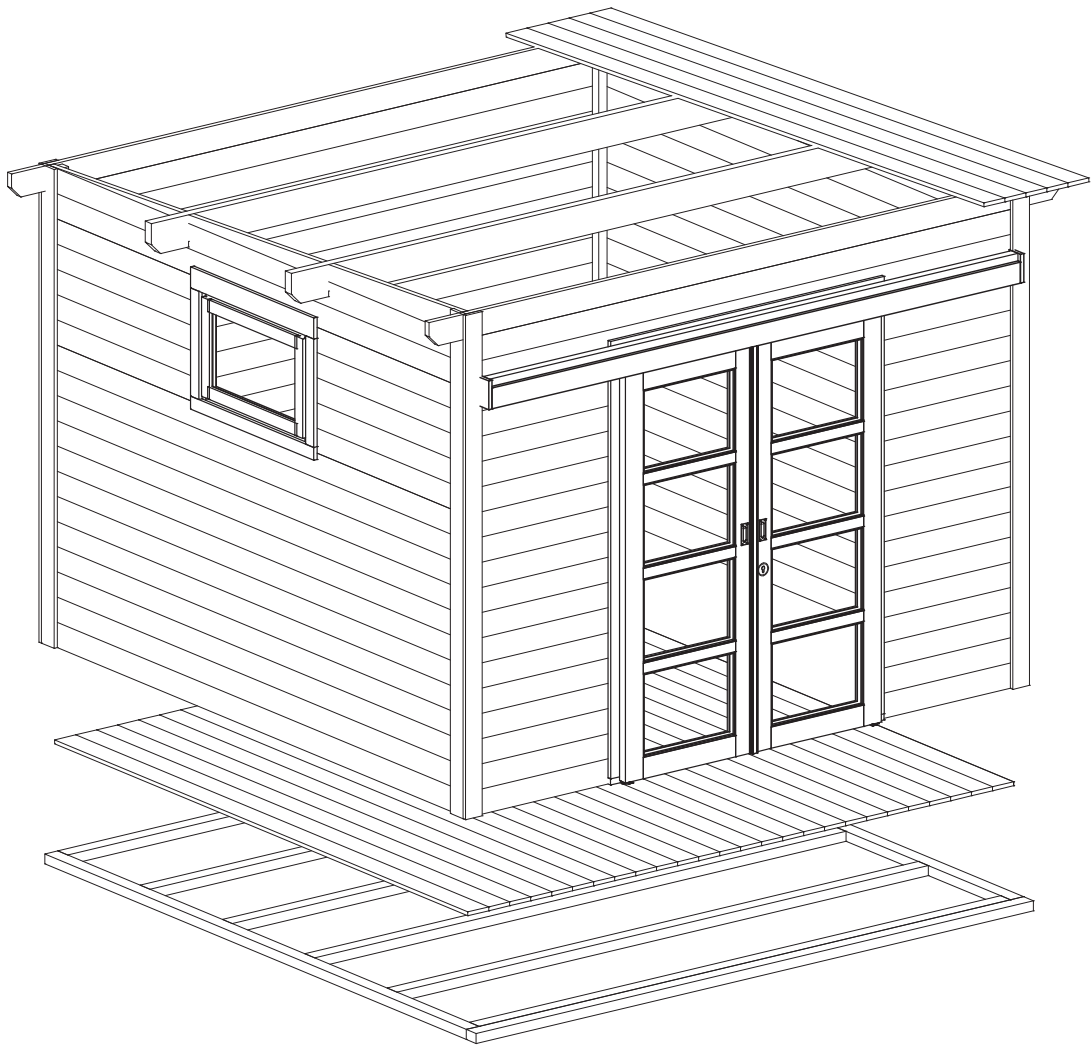

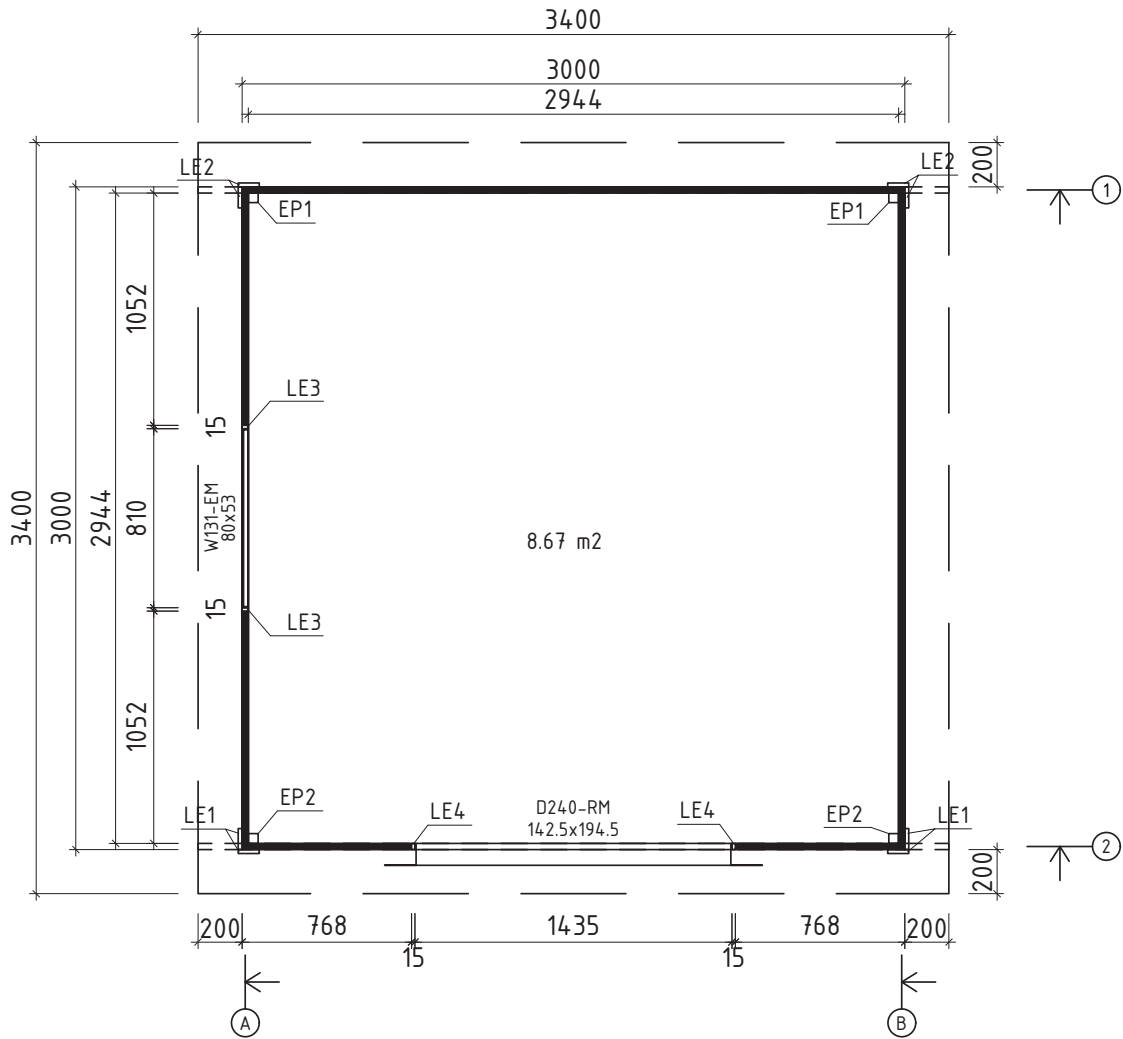





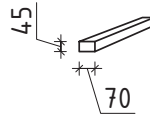
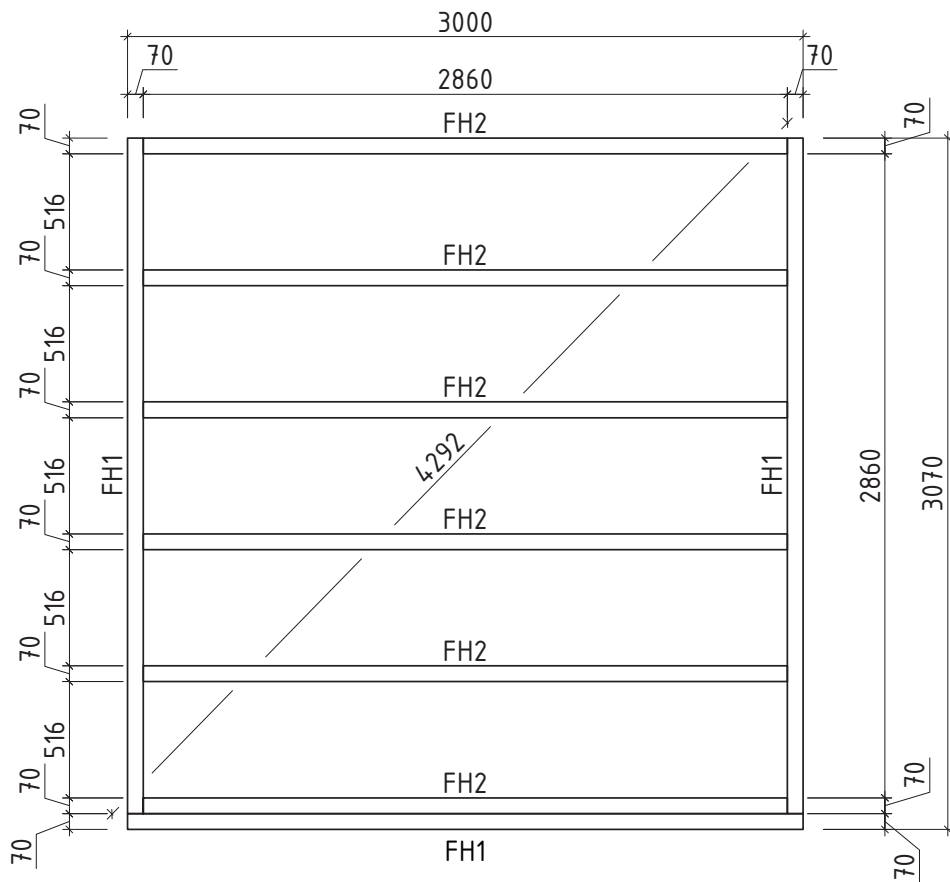





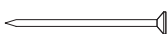

**Q2** – Qualitätsklasse für Fenster und Türen



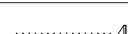





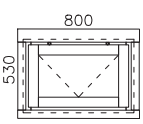
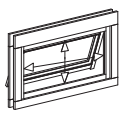
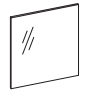

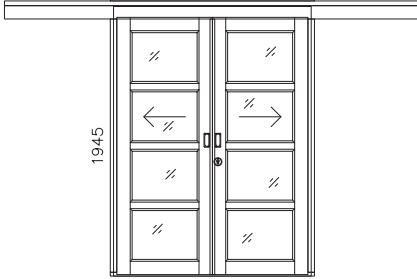
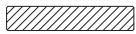



\* Fenster und Türen sind ohne Sprossen



Pos		Stck	Profil (mm)	Länge (mm)
001		2	28x114	3400
002		1	28x114	3000
003		19	28x114	3000
005		31	28x114	2944
006		10	28x114	1052
007		34	28x114	768
WA-1		1		
WB-1		1		
FH1	FUNDAMENTHÖLZER (imprägniert) 	3	70x45	3000
FH2	FUNDAMENTHÖLZER (imprägniert) 	6	70x45	2860
LE1	LEISTE 	✓ 4	95x18	2280
LE2	LEISTE 	✓ 4	95x18	2166
LE4	LEISTE 	2	15x28	1938
LE3	LEISTE 	2	15x28	560
EP2	ECKPFOSTEN 	2	44x44	2270
EP1	ECKPFOSTEN 	2	44x44	2156
PF1	PFETTEN 	2	44x145	3400
	DACHBRETTER	31+1	113x18	3400
	FUSSBODENBRETTER	27+1	113x18	2940
	FUSSBODENLEISTEN	✓	18x40	12,0 lfm
G02-1	GIEBELBRETTER 18x120	2	18x120	3420
G05-1	GIEBELDECKLEISTEN 18x40	✓ 2	18x40	3420
T02-1	TRAUFBRETTER 18x120	1	18x120	3436
T01-1	TRAUFBRETTER 18x95	1	18x95	3400
T04-1	TRAUFENDECKLEISTEN 18x40	1	18x40	3436
			Leht	1/4

Pos			Stck	Profil (mm)	Länge (mm)
T06-1	TRAUFENLEISTEN 18x40	 ✓		18x40	7,0 lfm
SH	Schlaghölzer		3		
KP-1	DACHPAPPE	 ✓		3,4m-4st.	14,0 lfm
NG01	DACHPAPPNÄGEL 2.8x15		230		
NG2 550	NÄGEL 2.5x50 Dachbretter		248		
NG2 560	NÄGEL 2.5x60 Fussbodenbretter		324		
SR3 030	SCHRAUBEN 3.0x30 Fussbodenleisten		24		
SR3 030	SCHRAUBEN 3.0x30 Giebeldeckleisten		16		
SR3 030	SCHRAUBEN 3.0x30 Traufenleisten		16		
SR3 545	SCHRAUBEN 3.5x45 Giebelbretter		16		
SR3 545	SCHRAUBEN 3.5x45 Leiste		124		
SR3 545	SCHRAUBEN 3.5x45 Traufenbretter		16		
SR3 545	SCHRAUBEN 3.5x45 Traufendeckleisten		8		
SR44	SCHRAUBEN 4.0x60 Wandbohlen zu Eckpfosten		312		
SR5 0100	SCHRAUBEN 5.0x100 Fundamenthölzer		36		
	✓ - bitte selber anpassen (falls nötig)!				
				Leht	2/4

Pos		Stck.	Profil (mm)	Länge (mm)
	<p style="text-align: center;"><b>FENSTER 800x530</b> <b>W2-S28E-0XM-08000530</b></p> <p><b>Q2</b> W131-EM</p>  <div style="display: flex; justify-content: space-between; align-items: flex-start;"> <div style="border: 1px solid gray; border-radius: 10px; padding: 5px; width: 150px;"> <p>Tilt window / Kippfenster / klappaken</p> </div> <div style="border: 1px solid gray; border-radius: 10px; padding: 5px; width: 150px;"> <p>Clear opening / durchgangsmaß / ava suurus</p> <p>686x416mm</p>  </div> </div> <div style="display: flex; justify-content: space-between; align-items: flex-start; margin-top: 10px;"> <div style="border: 1px solid gray; border-radius: 10px; padding: 5px; width: 150px;"> <p>matt glass Floatglas Satinert matt klaas</p> </div> <div style="border: 1px solid gray; border-radius: 10px; padding: 5px; width: 150px;">  <p>629x359mm</p> </div> </div>	1		
			Leht 3/4	

Pos		Stck	Profil (mm)	Länge (mm)
	<p>TÜR 1425x1945 D2-Q28R-LLM-14251945</p> <p>Q2 D240-RM 1425</p>  <p>Right handed / DIN rechts / paremakäeline</p> <p>Clear opening/ durchgangsmaß/ ava suurus 1337x1826mm</p> <p>matt glass Floatglas Safiniert matt klaas 492x375mm</p>	1		
LU-KL-01-1	LU - Cover strip - Deckbrett - Katteliist ukse kohale 	1	18x95	3000
LU-OK-01-1	LU - Covering - Endkappen - Otsakatik 	2	18x80	130
LU-KT-01-1	LU - Top frame - Obere Rahmenteil - Kandetala 	1	44x65	3000
UPL-1	Wind slat - Windleiste - Piluliist  ✓	1	10x35	1855
SR35-16-01	3.5x16RST LU Handle - Handgriff - Käepide 	16		
SR35-45-03	3.5x45 Cover strip - Deckbrett - Katteliist ukse kohale 	6		
SR35-45-06	3.5x45 Covering - Endkappen - Otsakatik 	4		
SR40-16-02	4.0x16 Wind slat - Windleiste - Piluliist 	4		
SR42-75-01	4.2x75 Door frames - Türrahmen - Ukselengid 	4		
SR50-90-02	5.0x90 Top frame - Obere Rahmenteil - Kandetala 	4		
LU-LS	LU - Cylinder lock - Zylinderschloss - Lukusüdamik 	1		
LU-KP	LU - Handle - Handgriff - Käepide 	4		
LU-LK	LU - Keyhole cover plate - Schlüsselloch Abdeckplatte - Võtmekilp 	1		
LU-SK	LU - Rail set - Schienenkompl.- Siinikomplekt 	2		
			Leht	4/4



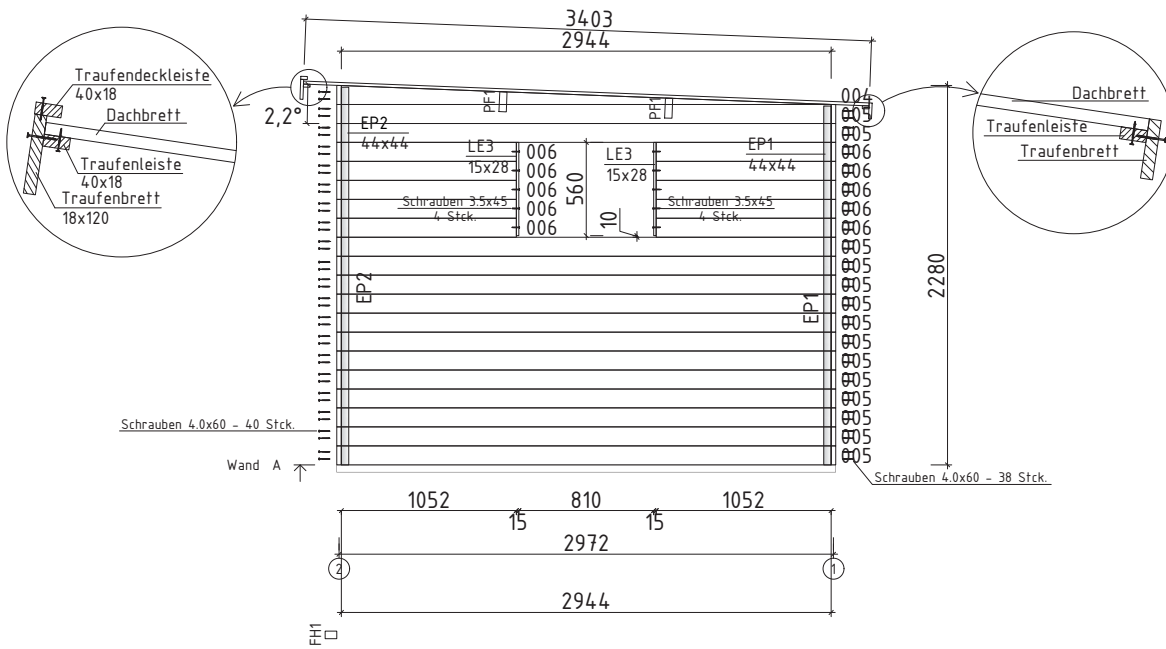

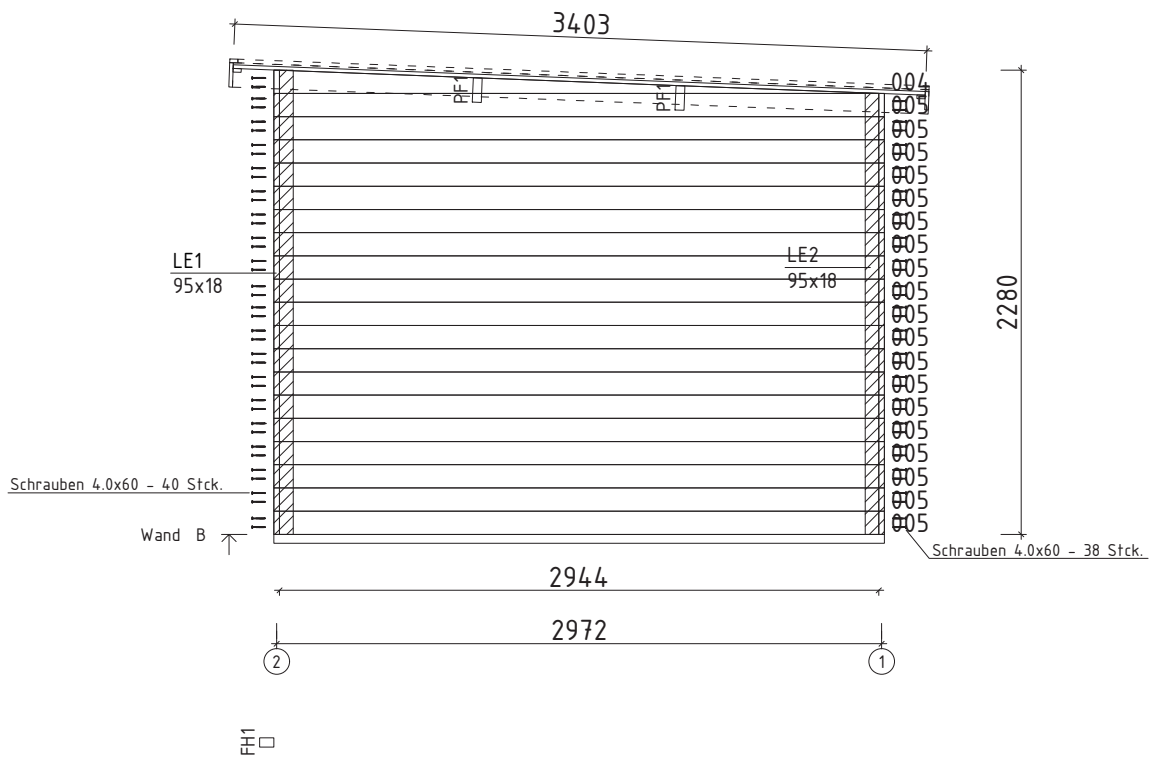

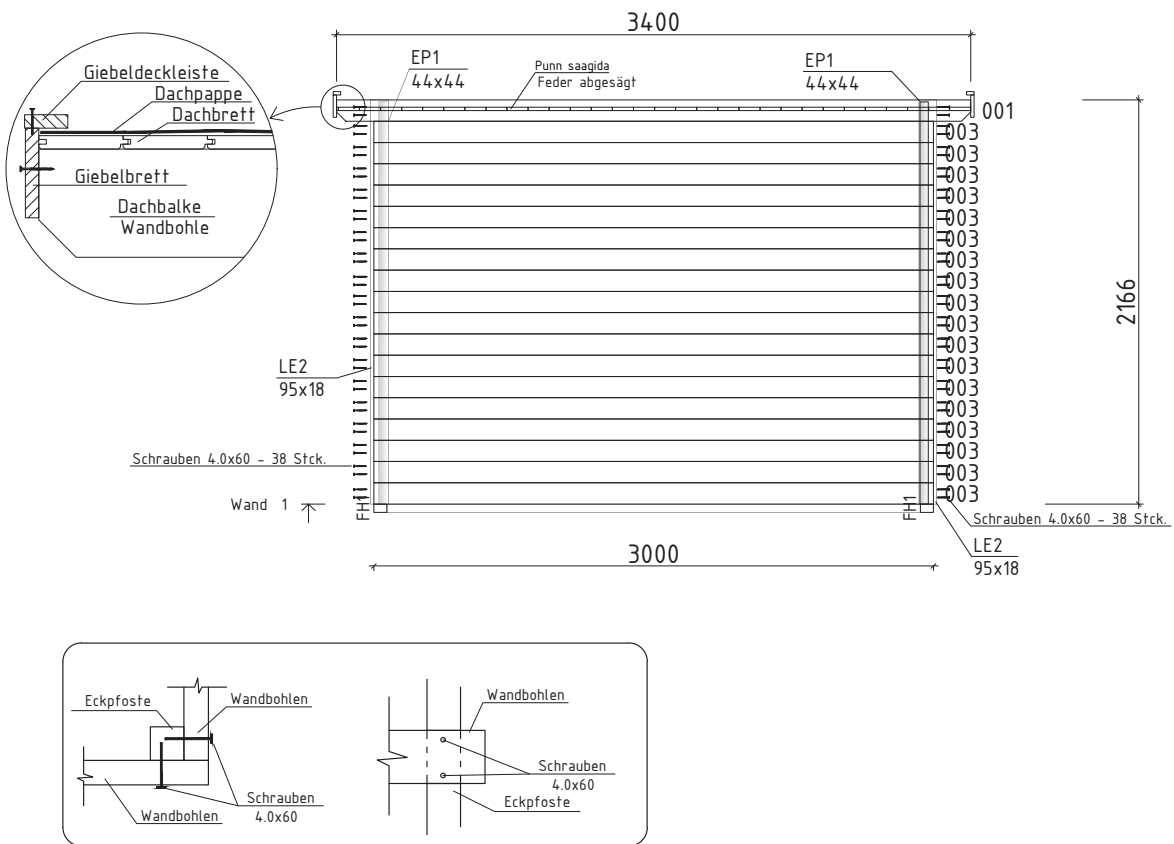

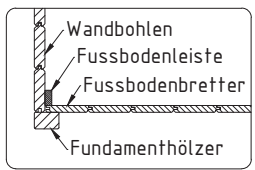
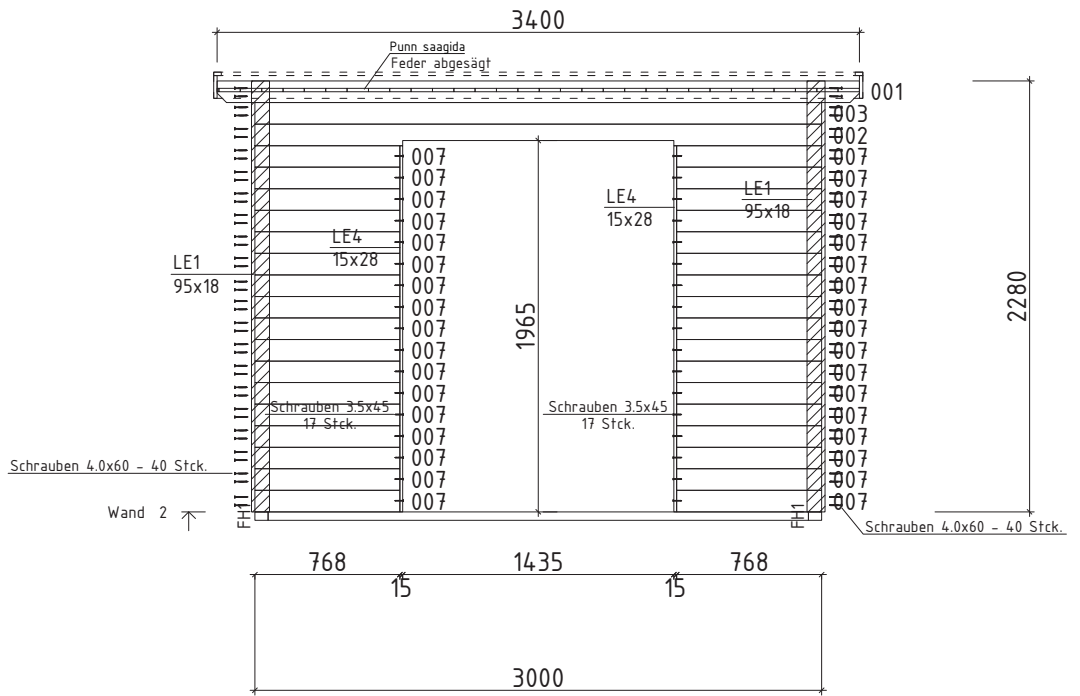

Q2-Q3 D240-RC

Installation instructions / Aufbauanleitung / Paigaldusjuhend

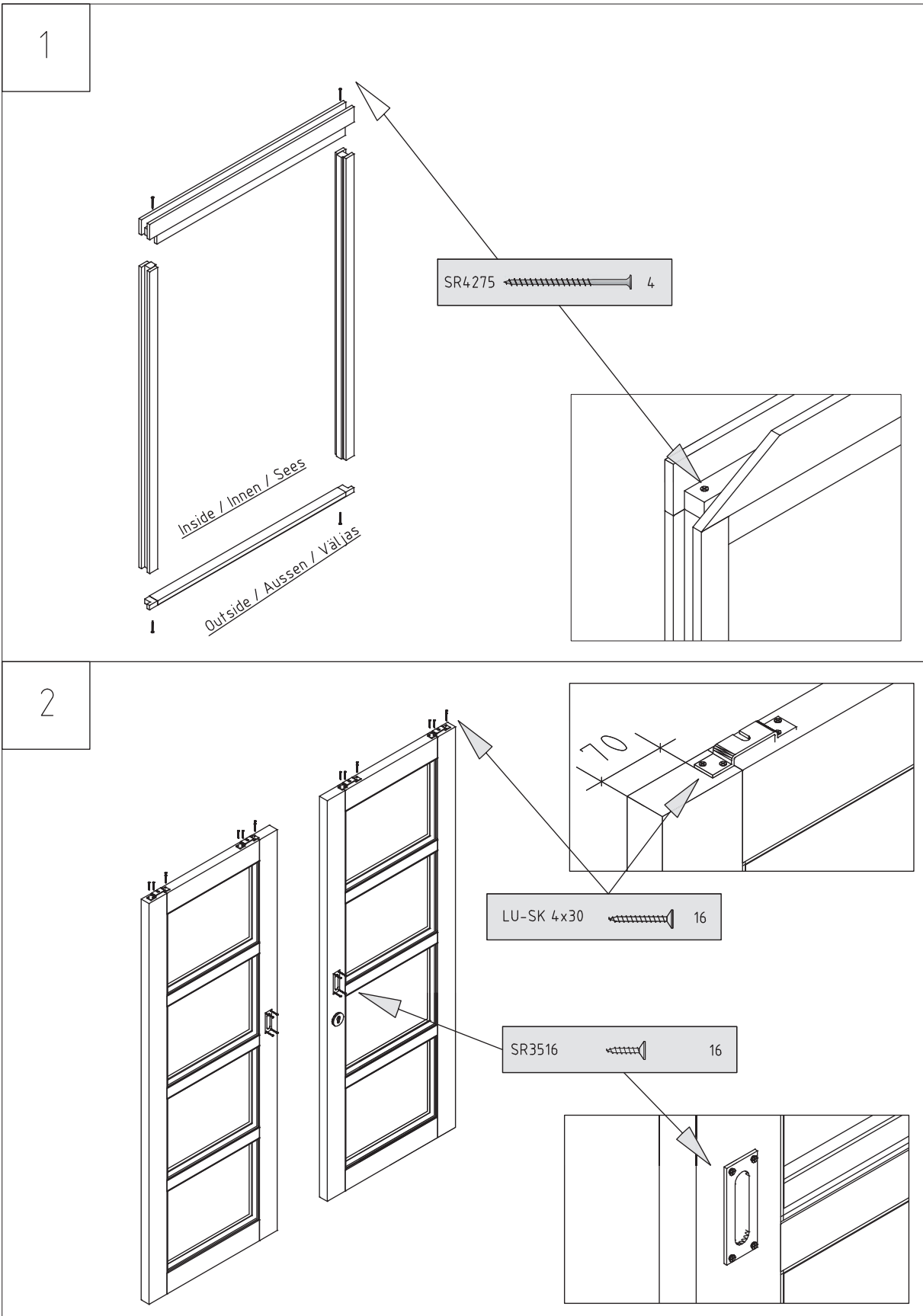

Q2-Q3 D240-RC

Installation instructions / Aufbauanleitung / Paigaldusjuhend

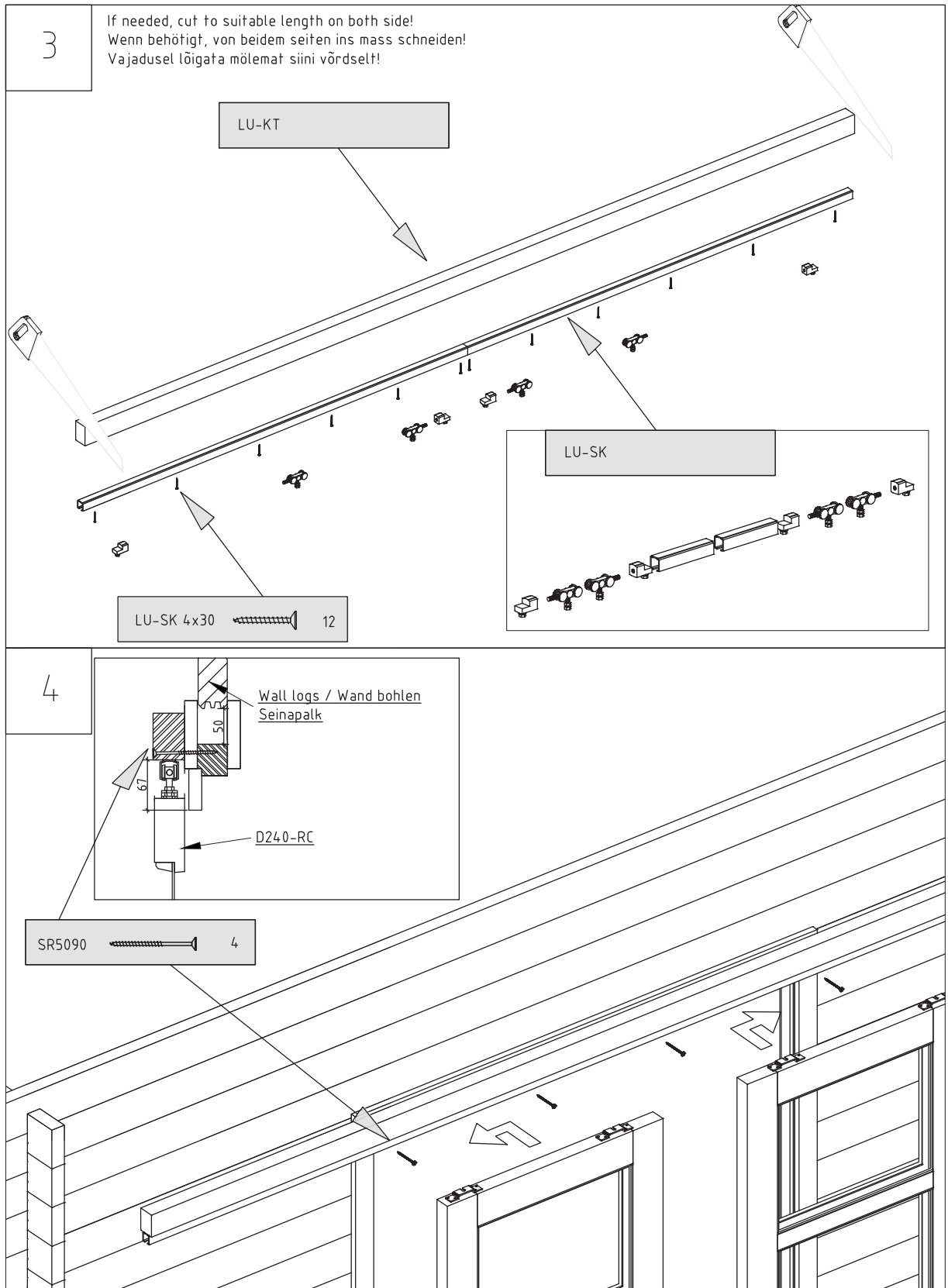

Q2-Q3 D240-RC

Installation instructions / Aufbauanleitung / Paigaldusjuhend

