

Technische Daten: Art.-Nr.: 846000

Wandaußenmaß: 360 x 300 cm

Bohlenstärke: 44 mm



Trondheim 70-D XL

Kontrolliert durch:

Empty box for signature or name.

Achtung: Alle angegebenen Maße sind ca.-Maße!

3D-Darstellung und Grundriss 846000

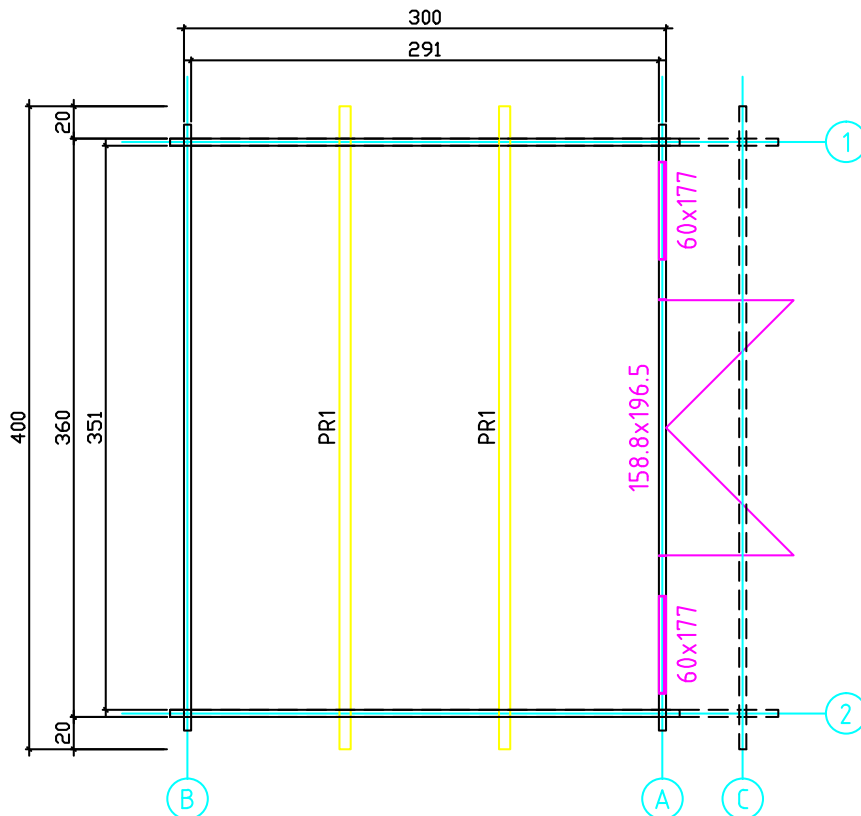
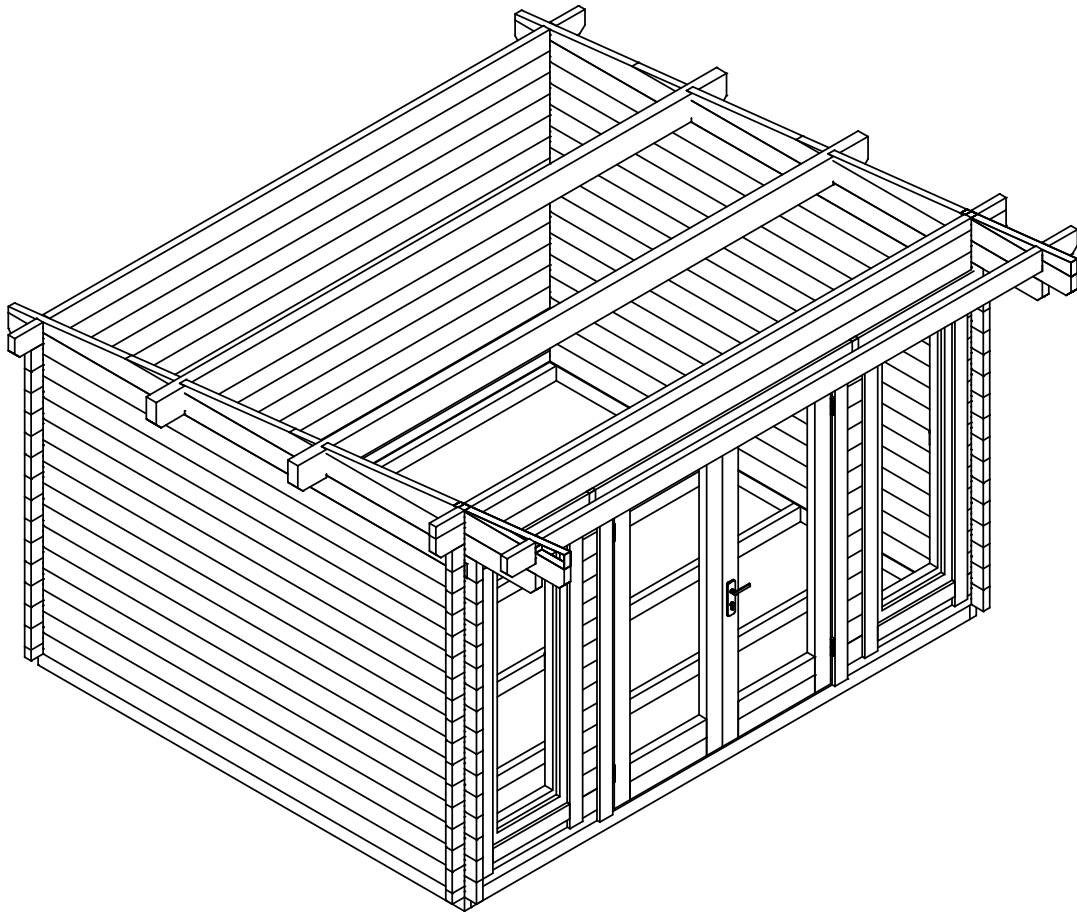

Lagerholzplan und Fundamentplan 846000

Wir empfehlen als Fundament für Ihr Gartenhaus eine vollflächig festgegründete, gepflasterte oder betonierte Fläche.
Wahlweise ist auch ein Punkt- oder Streifenfundament möglich.

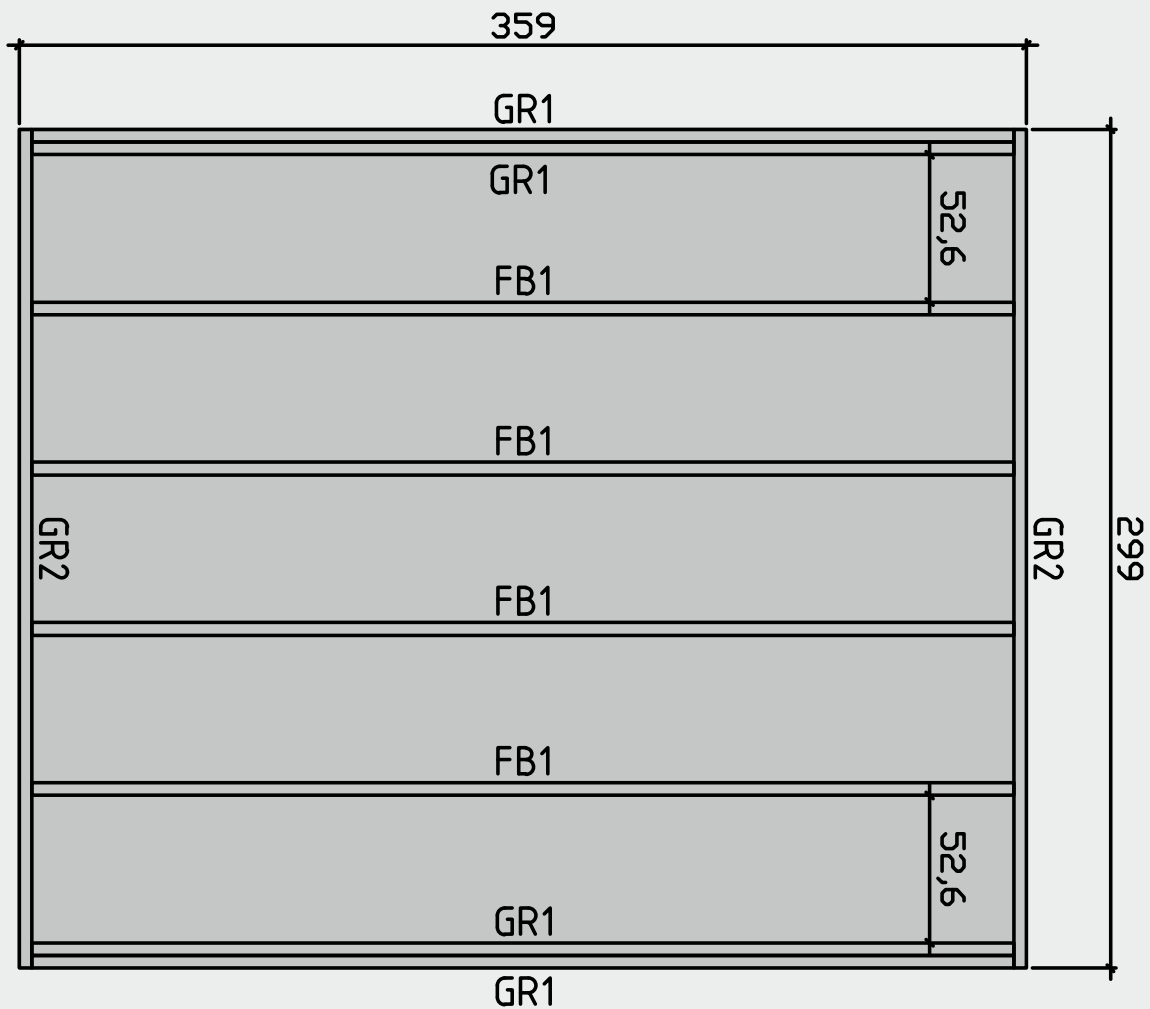











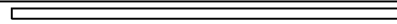

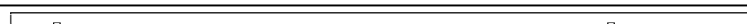

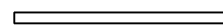

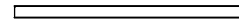
Teileliste 1

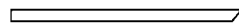
846000

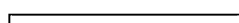
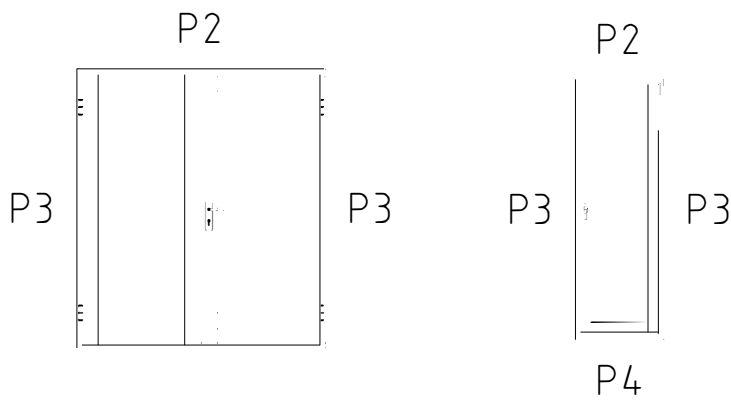
Pos	Quantity	Profil (mm)	Length (mm)
001	2	45x130	3170
002	2	45x130	3170
003	24	45x130	3170
004	2	45x130	3285
005	2	45x130	1173
006	2	45x130	2052
007	2	45x40	353
008	2	45x130	963
009	2	45x130	1473
010	2	45x22	194
011	2	45x130	1703
012	2	45x88	776
013	2	45x65	1086
014	2	45x130	1086
015	28	45x130	230
016	28	45x130	246
017	15	45x130	3770
018	1	45x130	4000
019	1	45x74	4000
020	1	45x65	3770
021	2	45x130	4000
GR1	4	45x90	3500
GR2	2	45x90	2990
FB1	4	45x90	3500
PR1	2	70x170	4000

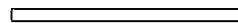
Teileliste 3

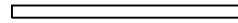
846000

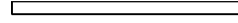
POS	ST.	B	H	L	Teileliste		
FB1	Vt. spetsi					FUNDMENTHOLZER	
F1	10,2m ²	28		2905		FUSSBODENBRETTER	
PR	2	70	170	4000		DACHBALKEN	
RB1	15,7m ²	20		3925		DACHBRETTER	
*R1	2	20	140	4040	Vaata katuse kalonenurka 	Traufenbretter	
*R2	2	45	45	4000	Vaata katuse kalonenurka 	Traufenbretter	
*R3	2	20	140	4120	Vaata katuse kalonenurka 	Giebelabschlussleiste	
*R4	2	20	90	4120		Giebelabschlussleiste	
DR1 WN1	1 2	1588 600	1965 1770				
*P1	14m	20	40			Fußbodenleiste	
*P2	1+1	20	90	3500		Türleiste DR1, Fensterleiste WN1	
*P3	6+6	20	90	1945		Türleiste DR1, Fensterleiste WN1	
*P4	2+2	20	90	540 570		Fensterleiste WN1	

*Wird als Fixlänge geliefert und muss bauseits zugeschnitten werden.

Wandplan 1 und 2 846000

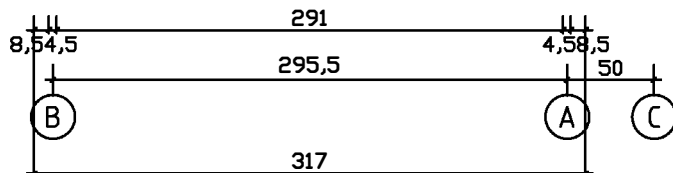
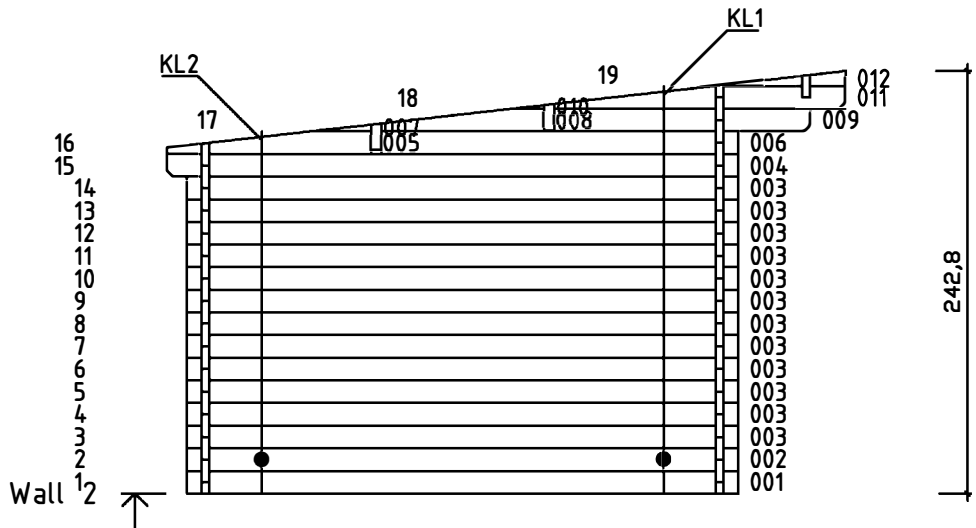
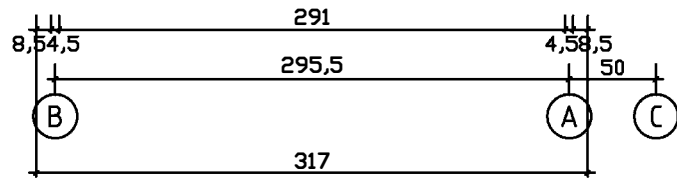
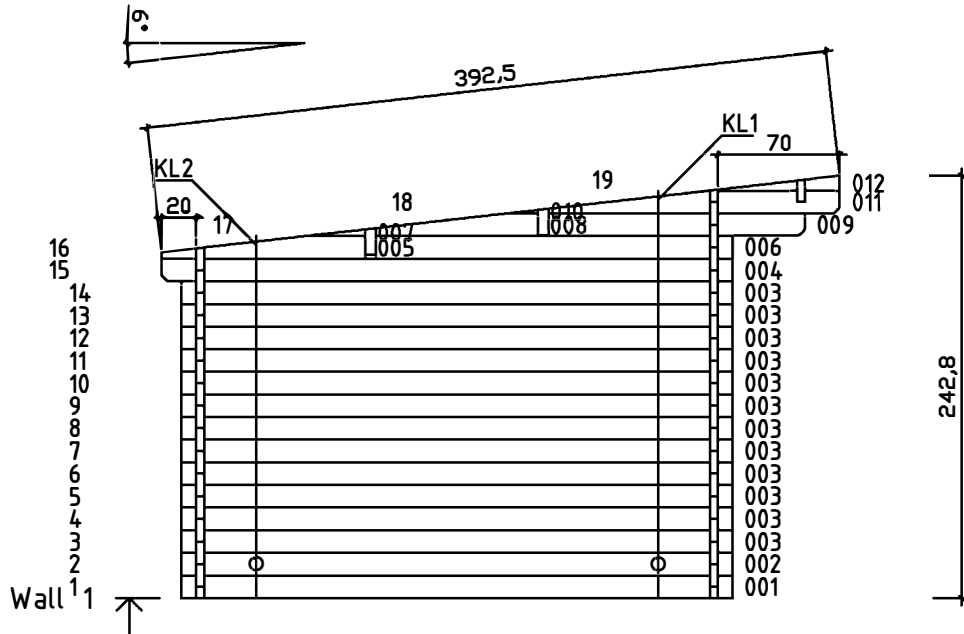

Wandplan A und B 846000

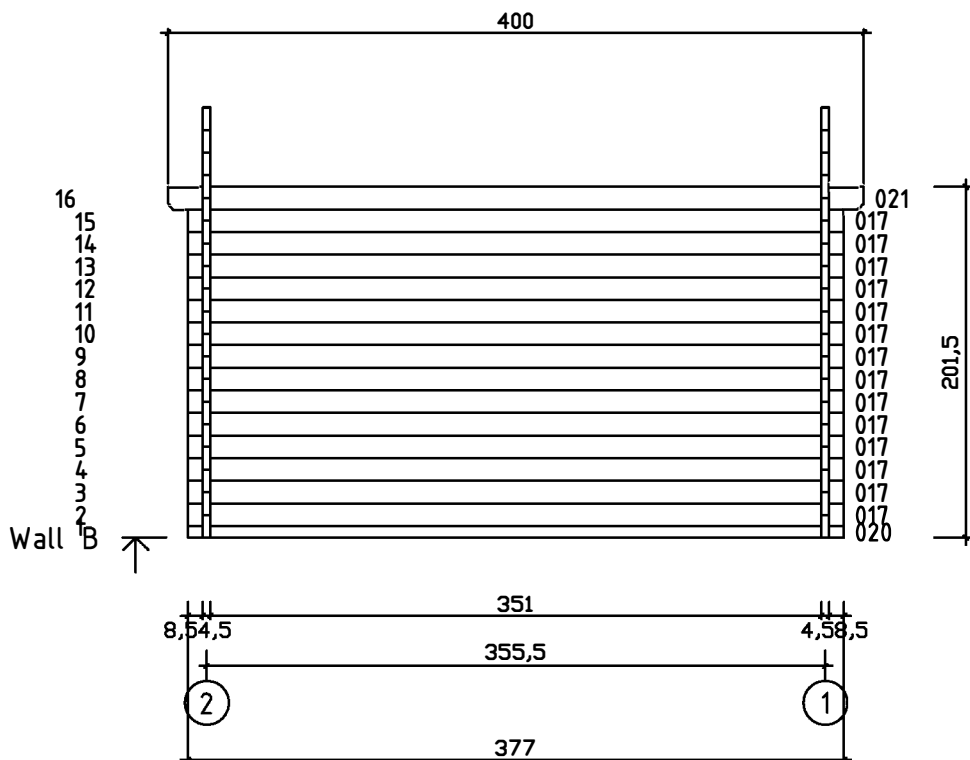
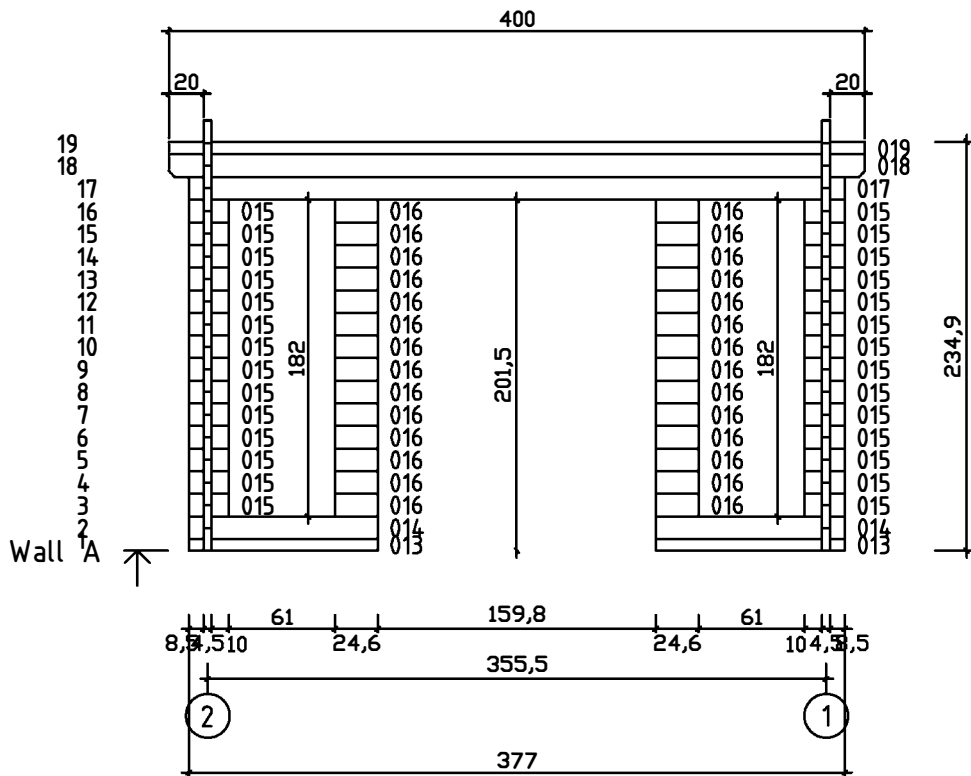

Wandplan C 846000

