

# Technische Daten



## Artikelnummer:

840 550, 810 590 ergibt



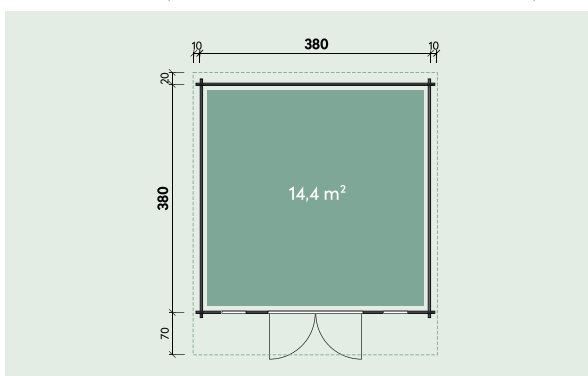





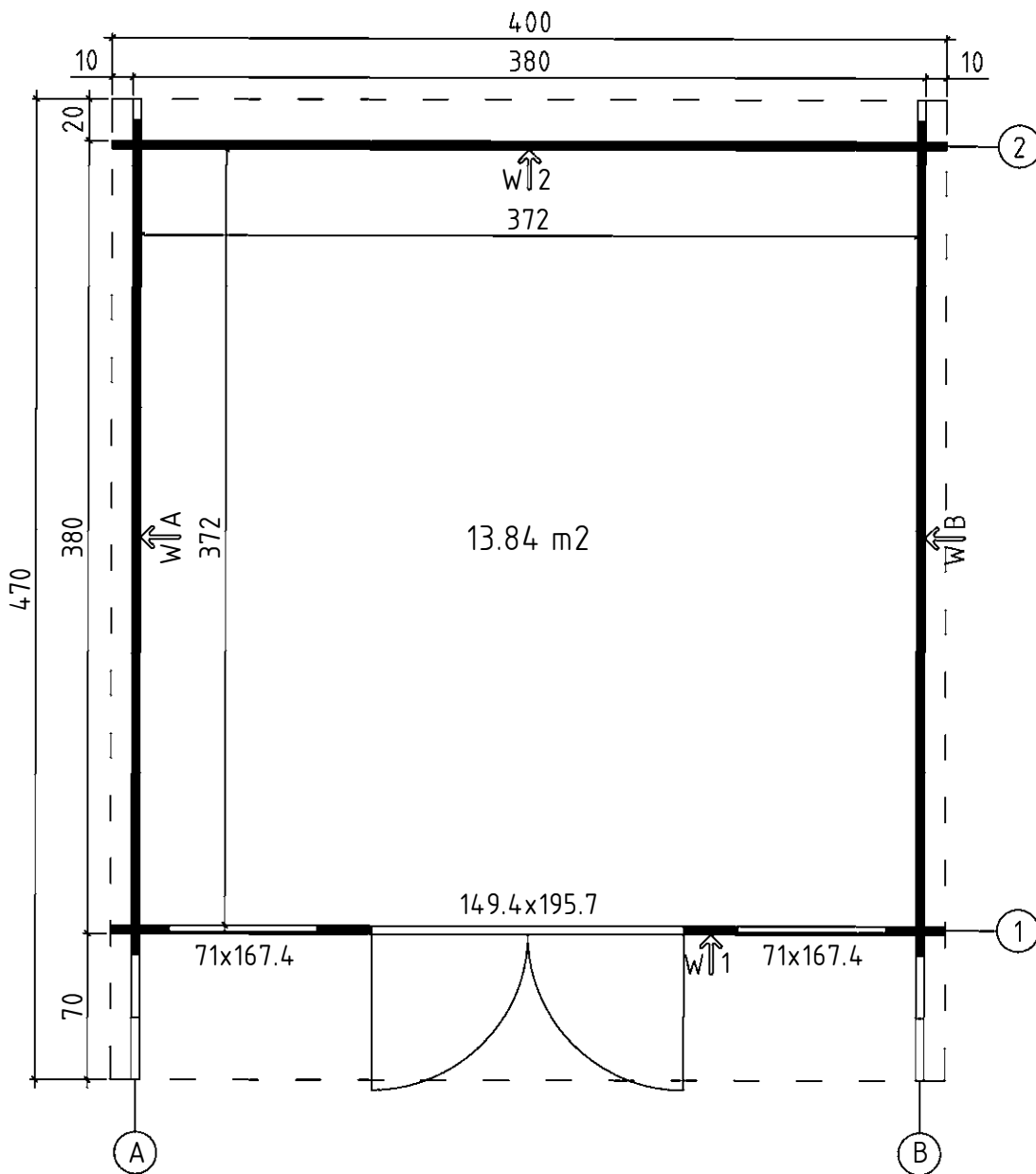

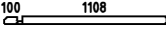
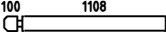

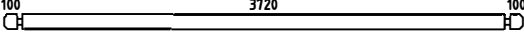
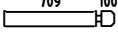

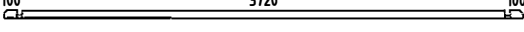
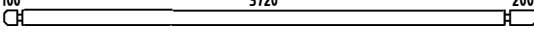
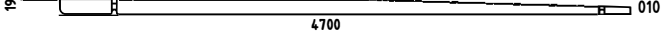
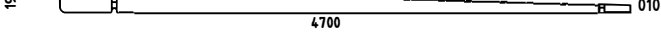
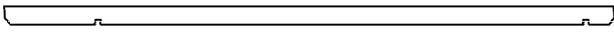
840 557, 851 201 Anthrazit, 851 202 Hellgrau



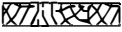
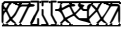

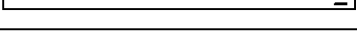
**Kontrolliert durch:**







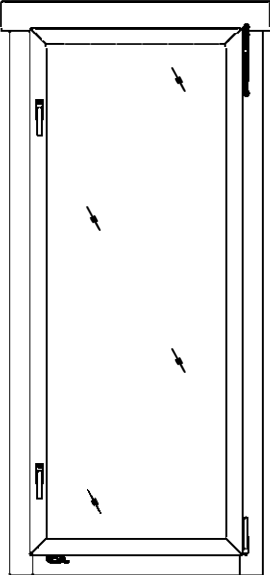
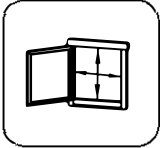

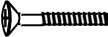

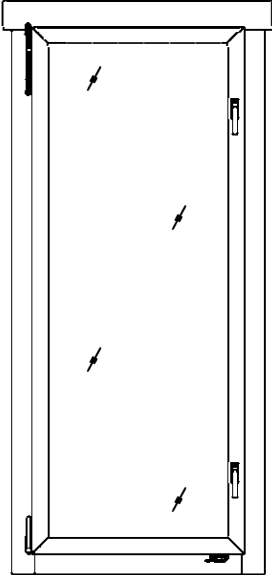
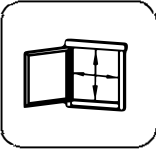

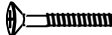

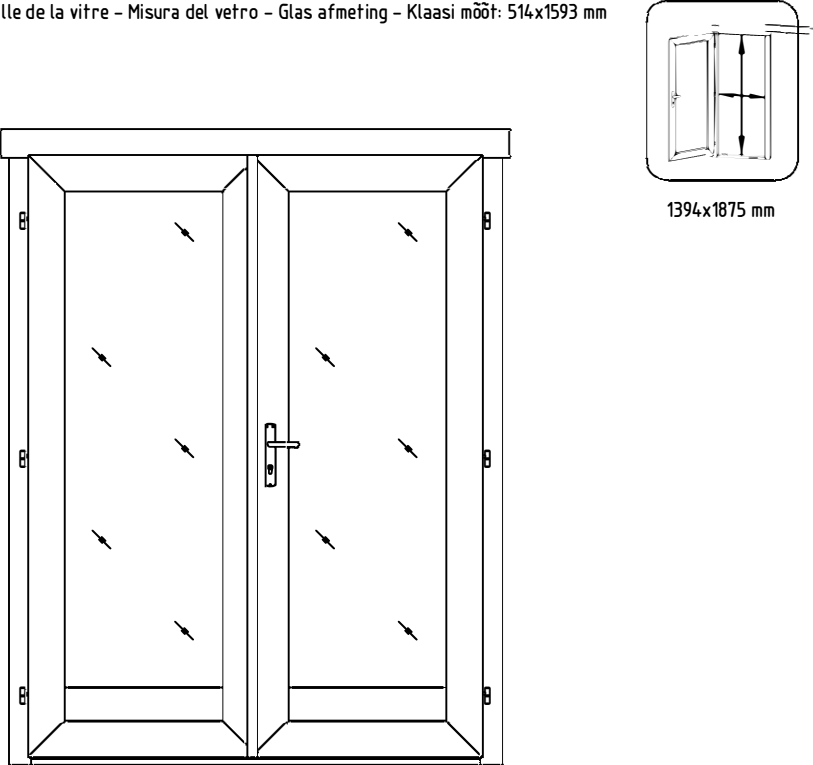
Nr.		Q	P (mm)	L (mm)
001		2	40x57	1248
002		4	40x114	1248
003		30	40x114	278
004		30	40x114	252
005		52	40x114	4000
006		4	40x114	848
007		6	40x114	709
008		1	40x57	4000
009		2	40x114	4100
WA-1		1		
WB-1		1		
SR1		4	44x140	4706
DB	Roof boards - Dachbretter - Voliges - Perlina per tetto - Dakhout - Katuselaud 	53	90x18	4000
RFF1	Roofing felt fillet - Dachpappenteiste - Baguette de fixation du feutre bitumeux - Asse per fissaggio guaina bituminosa - Afdekljst asfaltpapier - Katusepapiilist 	1	18x58	3920
RFF2	Roofing felt fillet - Dachpappenteiste - Baguette de fixation du feutre bitumeux - Asse per fissaggio guaina bituminosa - Afdekljst asfaltpapier - Katusepapiilist 	4	18x58	2400
TB1	Fascia board - Traufbrett - Bandeau de toit - Finitura lati tetto - Gevellijst - Räästalaud 	1	18x120	4000
TB2	Fascia board - Traufbrett - Bandeau de toit - Finitura lati tetto - Gevellijst - Räästalaud 	2	18x120	4800
TB3	Fascia board - Traufbrett - Bandeau de toit - Finitura lati tetto - Gevellijst - Räästalaud 	1	18x90	4000
KFS	Storm protection - Sturmleiste - Latte anti-tempete - Protezione anti vento - Stormverankering / beveiliging - Tormikinnitusliist 	2	22x45	2050
KFS-1	Storm protection - Sturmleiste - Latte anti-tempete - Protezione anti vento - Stormverankering / beveiliging - Tormikinnitusliist 	2	44x44	2160
HS12	Screw for fascia boards - Schrauben für traufbretter - Vis pour fixation bandeau de toit - Viti x striscia del tetto - Schroef voor gevellijst - Kruvi räästalaudale 	36	4x40	
HS18	Screw for roof beams - Schrauben für dachbalken - Vis pour fixation pannes de toit - Viti per perline del tetto - Schroef voor gordingen / dakbalken - Kruvi pärlinitele 	8	5x120	
HS18	Screw for gable - Schrauben für giebel - Vis pour fixation des pignons - Viti per timpano - Schroef voor gevelpunt - Kruvi viilude kinnitamiseks 	4	5x120	

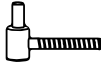

Nr.		Q	P (mm)	L (mm)
	<p data-bbox="220 356 1082 383">Glass size – Glasgröße – Taille de la vitre – Misura del vetro – Glas afmeting – Klaasi mõõt: 566x1530 mm</p>   <p data-bbox="1150 521 1259 546">610x1574 mm</p>			
FS1	<p data-bbox="220 1951 863 2000">Window handle fittings – Fenstergriff – Poignée de fenetre – Maniglia c/ferramenta – Raamhendel –/grendel –/klink – Aknalink</p> 	2		
FSP	<p data-bbox="220 2018 932 2083">Bolt for window handle fittings – Bolzen für fenstergriff beschlag – Vis pour fixation poignée de fenetre – Bullone x apertura manuale finestra – Schroef voor raamhendel – Akna käepideme polt</p> 	4		

Nr.		Q	P (mm)	L (mm)
	<p data-bbox="344 349 1211 376">Glass size - Glasgröße - Taille de la vitre - Misura del vetro - Glas afmeting - Klaasi mõõt: 566x1530 mm</p>   <p data-bbox="1278 512 1382 539">610x1574 mm</p>			
FS1	<p data-bbox="344 1939 991 1991">Window handle fittings - Fenstergriff - Poignee de fenetre - Maniglia c/ferramenta - Raamhendel -/grendel -/klink - Aknalink</p> 	2		
FSP	<p data-bbox="344 2007 1059 2072">Bolt for window handle fittings - Bolzen für fenstergriff beschlag - Vis pour fixation poignee de fenetre - Bullone x apertura manuale finestra - Schroef voor raamhendel - Akna käepideme pööt</p> 	4		

Nr.		Q	P (mm)	L (mm)
	<p>Glass size – Glasgröße – Taille de la vitre – Misura del vetro – Glas afmeting – Klaasi mõõt: 514x1593 mm</p> 			
HS4	<p>Screw for door fillet – Schraube zur Befestigung türleiste – Vis pour fixation baguette d'arrêt de porte – Viti per massellino della porta – Schroef voor deurlijst – Kruvi ukse kokkuvaltšiliistule</p>	 <p>5</p>	3x30	
HS16	<p>Screw for door jamb – Schraube für Türrahmen – Vis de fixation partie haute avec montants du cadre de porte – Viti x fissaggio montanti porte – Schroef voor deurkozijn – Kruvi ukse lengile</p>	 <p>4</p>	5x90	
HS25	<p>Screw for doorstep – Schrauben für Schwelle – Vis pour fixation barre de seuil – Vite per soglia della porta – Schroef voor deurdorpel – Kruvi lävepakule</p>	 <p>3</p>	4.5x65	
TL4	<p>Door handle fittings – Türgriff – Poignée de porte – Maniglia – Deurhendel / klink – Ukse käepide</p>	 <p>1</p>		
TL5	<p>Set of door lock covers – Schlossblenden – Set de garnitures de porte – Copertura serrature – Slot sluitplaat set – Ukse lukuplaat</p>	 <p>1</p>		
	<p>Cylinder lock – Zylinderschloss – Barillet de porte – Serratura – Cylinder slot – Ukse lukusüdamik</p>	 <p>1</p>	30x35	
	<p>Male bolt hinge for door – Türband – Partie male de paumelle de porte – Cerniera anube x porta – Scharnier bout – Ukse polthing isane</p>	 <p>6</p>		
	<p>Striker for barrel bolt – Hülse für Grendelriegel – Gache au sol du targette – Boccola per fermo della porta – Huls voor vergrendelingsschuif – Vasturaud ukse servariivile</p>	 <p>2</p>		





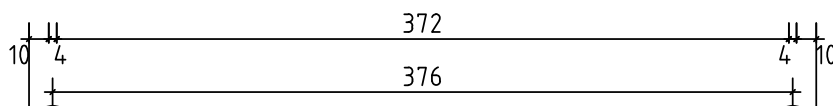
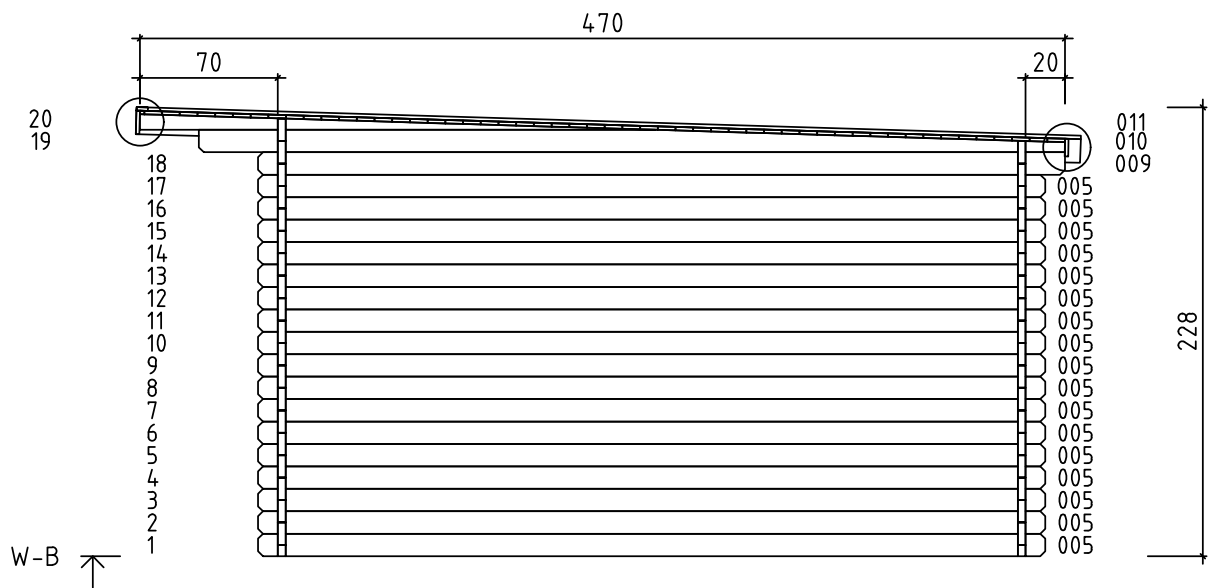
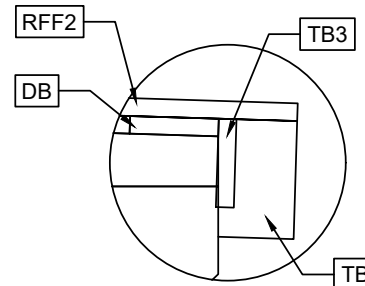
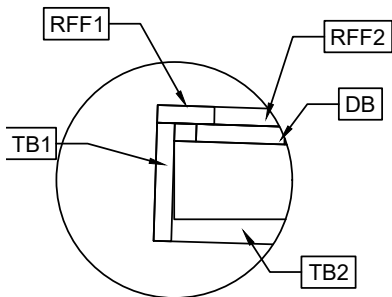
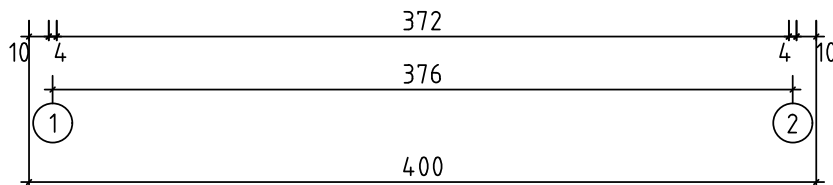
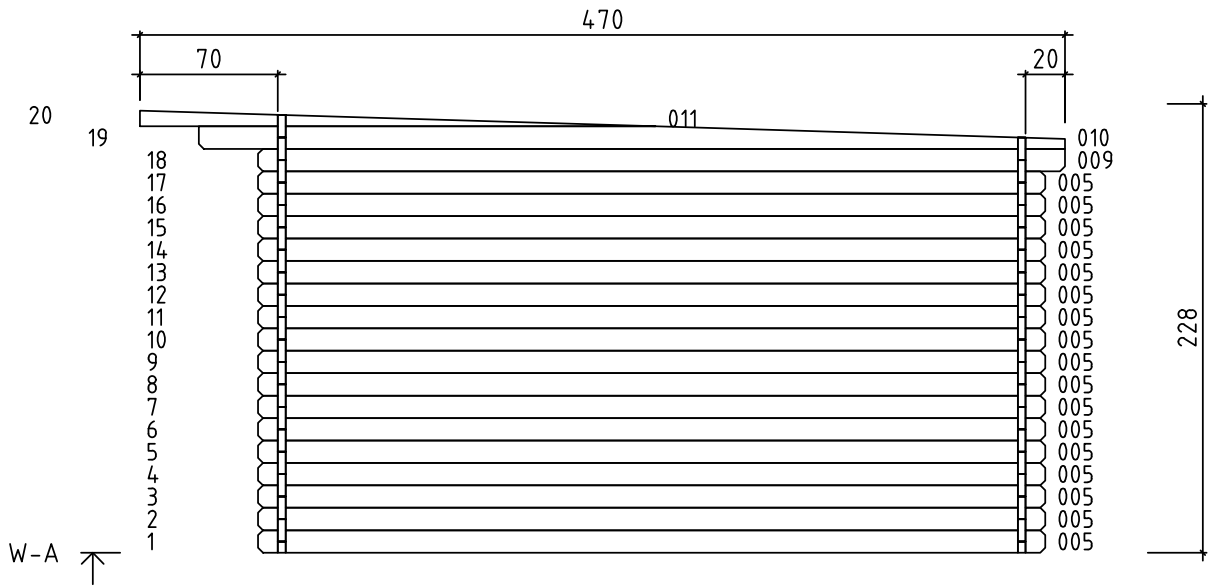

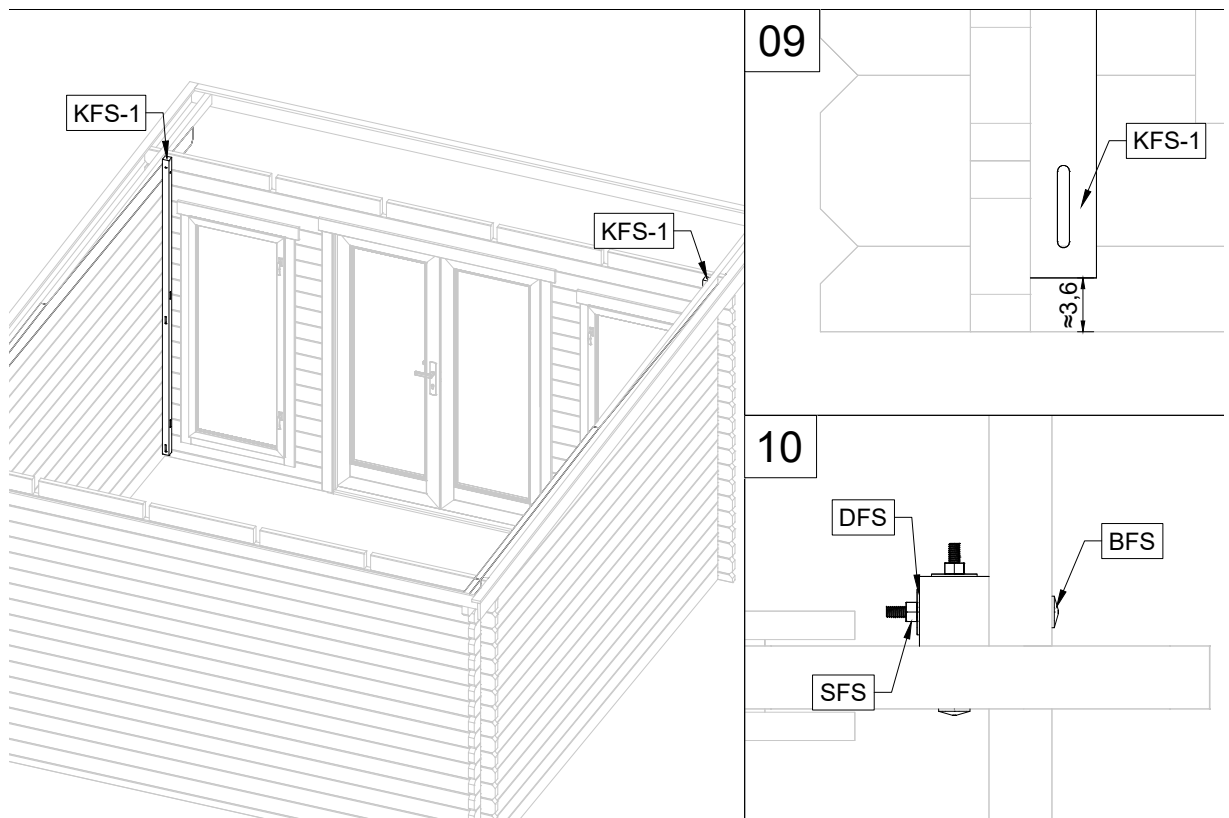

## Technische Daten: Art.-Nr.: 810 590

Wandaußenmaß: 380 x 380 cm

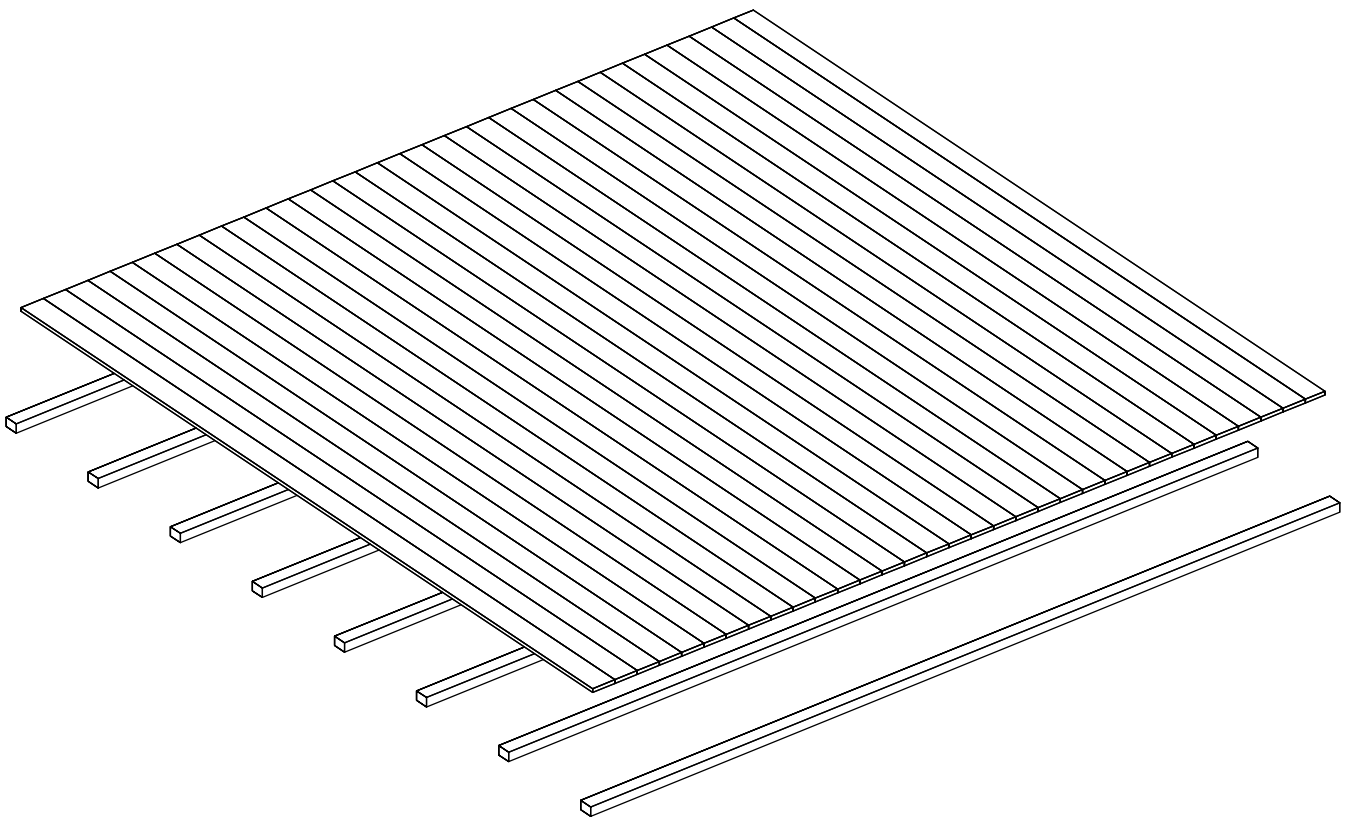

Kontrolliert durch:

Achtung: Alle angegebenen Maße sind ca.-Maße!

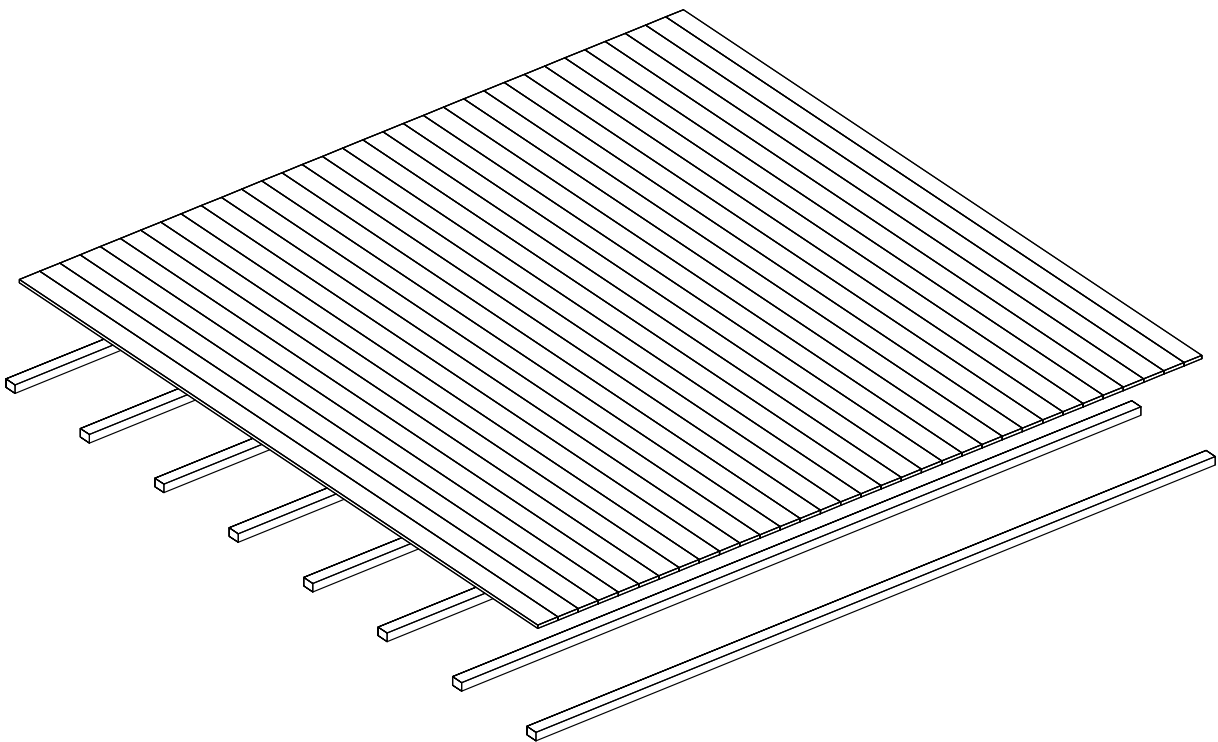

**Wir empfehlen als Fundament für Ihr Gartenhaus, mit Artikelnummer 810590, eine vollflächig festgegründete, gepflasterte oder betonierte Fläche. Wahlweise ist auch ein Punkt- oder Streifenfundament möglich.**

