

Technische Daten: Art.-Nr.: 870600

Wandaußenmaß: 360 x 300 cm

Bohlenstärke: 70 mm



Nordkap 70-C, durch Kunden farblich endbehandelt.

Kontrolliert durch:

Achtung: Alle angegebenen Maße sind ca.-Maße!

3D-Darstellung und Grundriss 870600

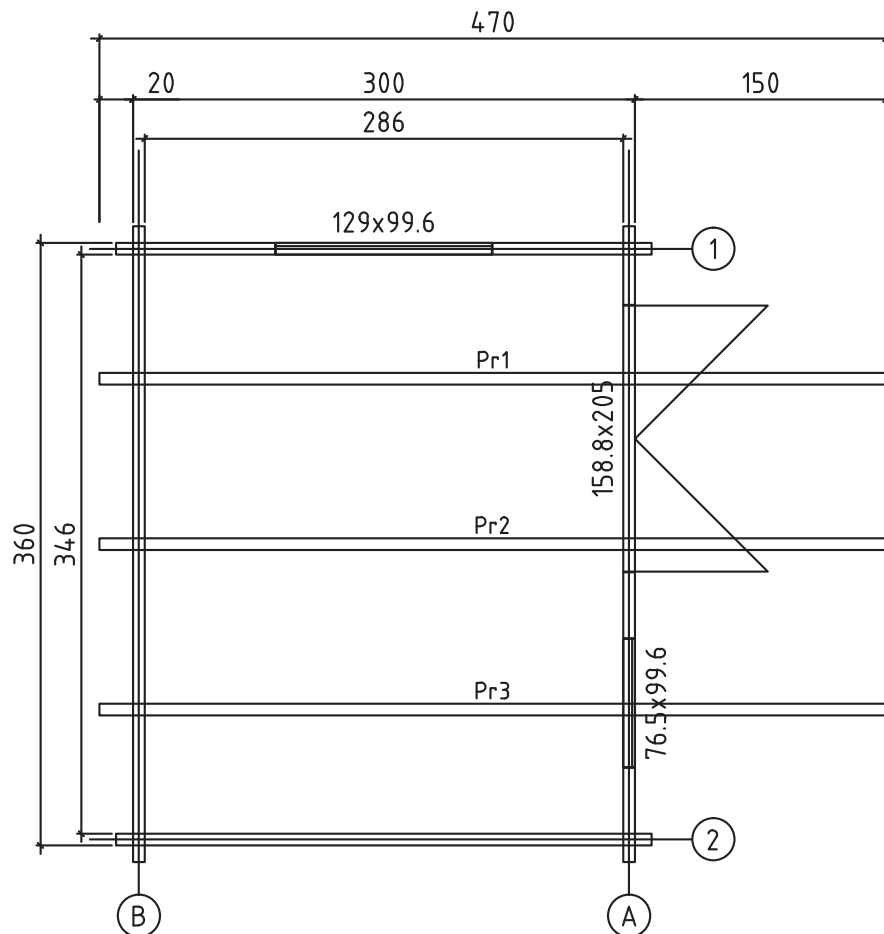
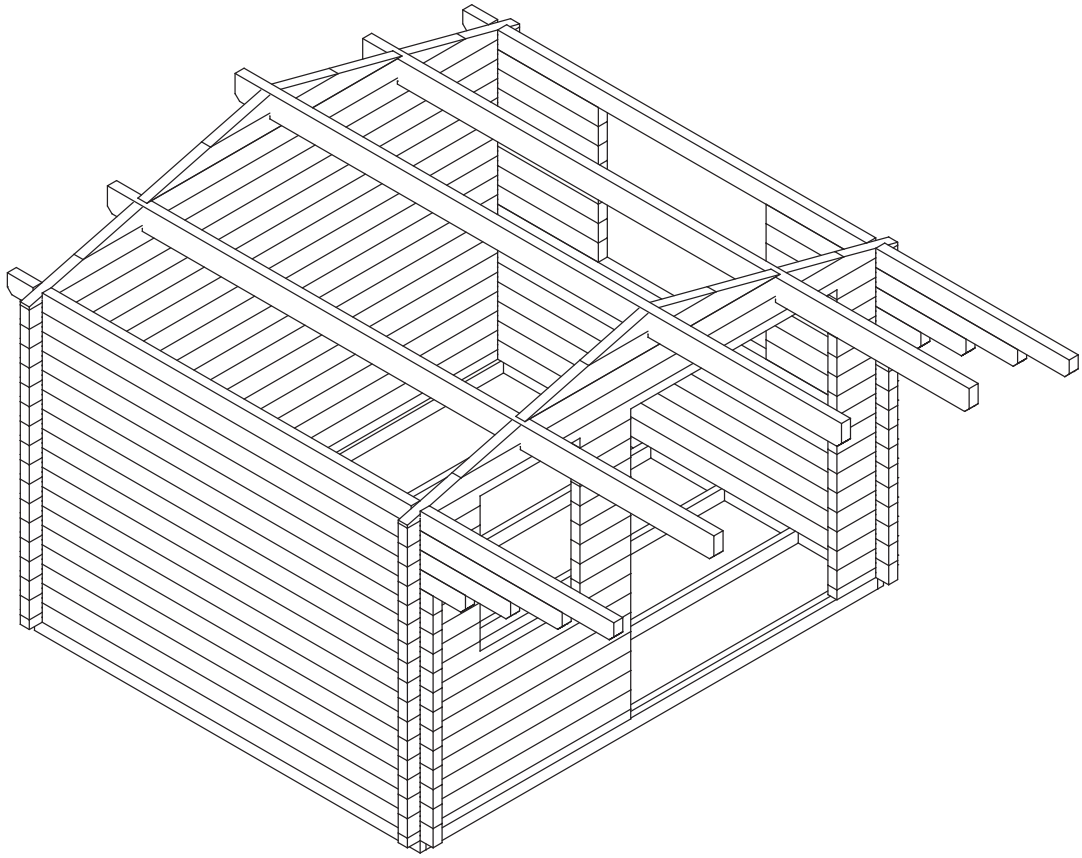





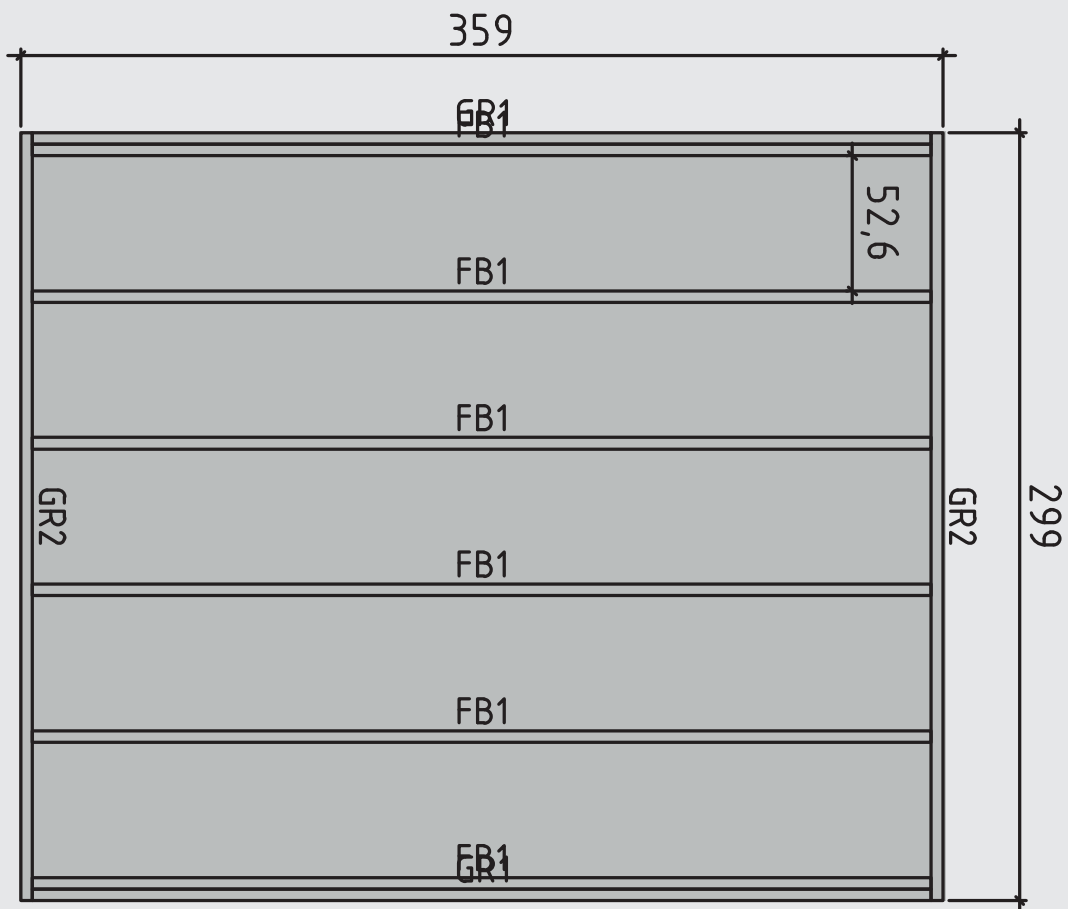



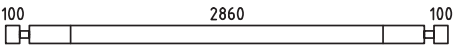
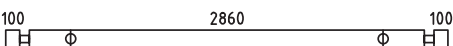
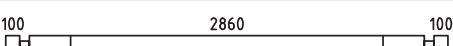
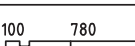
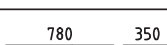
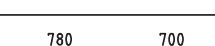
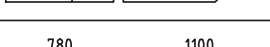

Lagerholzplan und Fundamentplan 870600

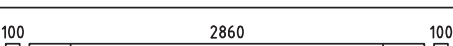
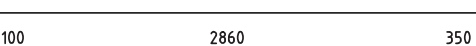
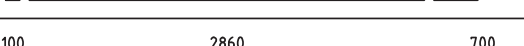
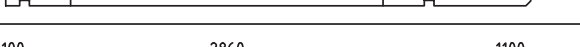
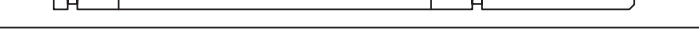
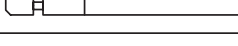
Wir empfehlen als Fundament für Ihr Gartenhaus eine vollflächig,
festgegründete gepflasterte oder betonierte Fläche.
Wahlweise ist auch ein Punkt- oder Streifenfundament möglich.



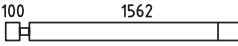

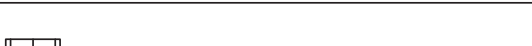
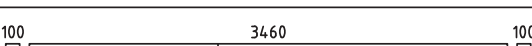









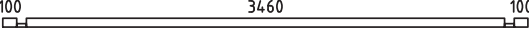
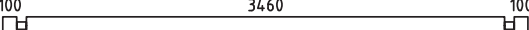
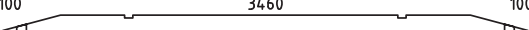
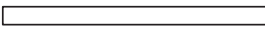

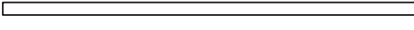
Teileliste 1

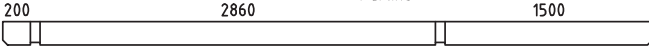
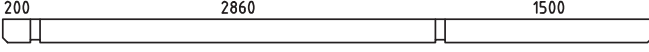
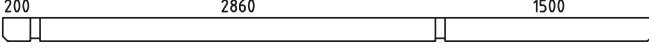
870600

Pos			Profil (mm)	Lenght (mm)
001		2	70x130	3200
002		1	70x130	3200
003		17	70x130	3200
004		13	70x130	950
005		1	70x130	1200
006		1	70x130	1550
007		1	70x130	1950
008		1	70x130	4700
009		1	70x130	3200
010		1	70x130	3450
011		1	70x130	3800
012		1	70x130	4200
013		1	70x130	4700
014		1	70x65	1732
015		1	70x65	470
016		1	70x130	1732
017		15	70x130	470
018		6	70x130	1732
019		1	70x130	1732
020		7	70x130	563
021		7	70x130	394
022		1	70x130	3800
023		1	70x130	3800
024		7	70x122	464
025		1	70x130	1917



Teileliste 2

870600

Pos			Profil (mm)	Lenght (mm)
026			70x130	1977
027			70x122	464
028			70x65	3800
029			70x130	3800
030			70x130	3800
031			70x130	1917
032			70x130	1977
GR1			45x90	3500
GR2			45x90	2990
FB1			45x90	3500
Pr1			70x170	4700
Pr2			70x170	4700
Pr3			70x170	4700
	WINDOW 1290x996			
	WINDOW 765x996			
	DOOR 1588x2050			
1	Screws/Schrauben/Vis 5x100 mm- For fixing first row of wall logs /Fixierung des ersten Bohlenkranzes/Pour fixer les lames de plancher			6
2	Nails/Nägel/Clous 2.5x50 - For fixing floorboards/ Befestigung Fussbodenbretter/Pour fixer les lames de plancher			280
3	Nails/Nägel/Clous 2.5x50 - For fixing roofboards/ Befestigung Dachbretter/Pour fixer les voliges			370
4	Nails/Nägel/Clous 2.5x50 - For fixing floor edge trims/ Befestigung Fussleisten/Pour fixer les plinthes du plancher			30
5	Nails/Nägel/Clous 2.5x50 - For fixing roofing felt fillet/ Befestigung giebelabschlussbrett/Pour fixer la latte de finition de la couverture			20
6	Screws/Schrauben/Vis 2,5x50 mm- For fixing roof side boards and roof edge reinforcement Befestigung Traufenbretter und Traufenleisten Pour fixer les planches de rive et le tasseau de refront			44
7	Screws/Schrauben/Vis 2,5x50 mm- For fixing fascia boards and diamonds/ Befestigung Giebelblende und Raute Pour fixer les planches de rive et le diamant			28
8	Screws/Schrauben/Vis 2,5x50 mm- For fixing fwindow and door trims/ Befestigung Fenster und türen/ Pour fixer les croissilons des fenetres et des portes			44















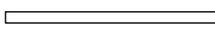

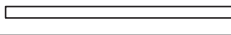



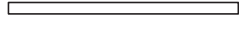
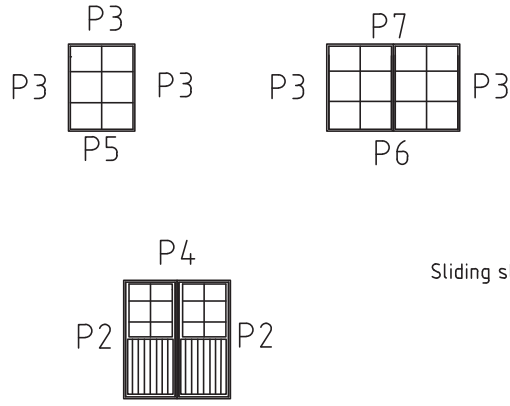

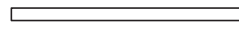
Teileliste 3

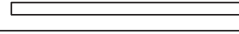
870600

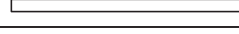
Pos			Profil (mm)	Lenght (mm)
9	Metal storm Brace/Gewindestange/Tige filetee 10 mm 		5	
10	Shim;Nuts/Mutter ,U-Scheibe/Ecrou;Rondelle 10 mm For fixing storm braces/ Pour fixer les anti tempete/ Für Sturmleisten Pour fixer les croissilons des fenêtrés et des portes 		5 / 5	
	Metal storm Brace/Gewindestange/Tige filetee 10 mm KL1 M10 2,31 m 4 Screws 180 10 pcs. KL2 M10 2,76 m 1 Plastic caps 5 pcs.			

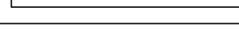
Teileliste 4

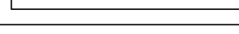
870600

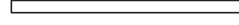
POS	ST.	B	H	L	Teileliste	
FB1	Vt. spetsi					FUNDMENTHOLZER
F1	9,89 m ²	28		2855		FUSSBODENBRETTER 40/31/26
PR	3	70	170	4700		DACHBALKEN
RB1	19,92 m ²	20		2120		DACHBRETTER 122/94/78
R1	2	20	120	4700	<i>Vaata katuse kaldenurka</i> 	Traufenbretter 
R2	2	45	65	4700	<i>Vaata katuse kaldenurka</i> 	Traufenbretter 
R3	4	20	120	2300	<i>Vaata katuse kaldenurka</i> 	Giebelabschlussleiste 
R4	4	20	90	2300		Giebelabschlussleiste 
WN07	1	765	996		 <p>Sliding slats 30x30x1900 mm - 2 pcs. 30x30x800 mm - 2 pcs.</p>	
WN13	1	1290	996			
DR16	1	1588	2050			
P1	14 m	20	40			Fußbodenleiste
P2	2+2	20	90	2030		Türleiste DR16 
P3	10	20	90	1100		Fensterleiste WN13; WN07 
P4	1+1	20	90	1890		Türleiste DR16 
P5	1+1	20	90	725		Fensterleiste WN07 
P6	1+1	20	90	1250		Fensterleiste WN13 
P7	1+1	20	90	1590		Fensterleiste WN13 

Detailzeichnungen 870600

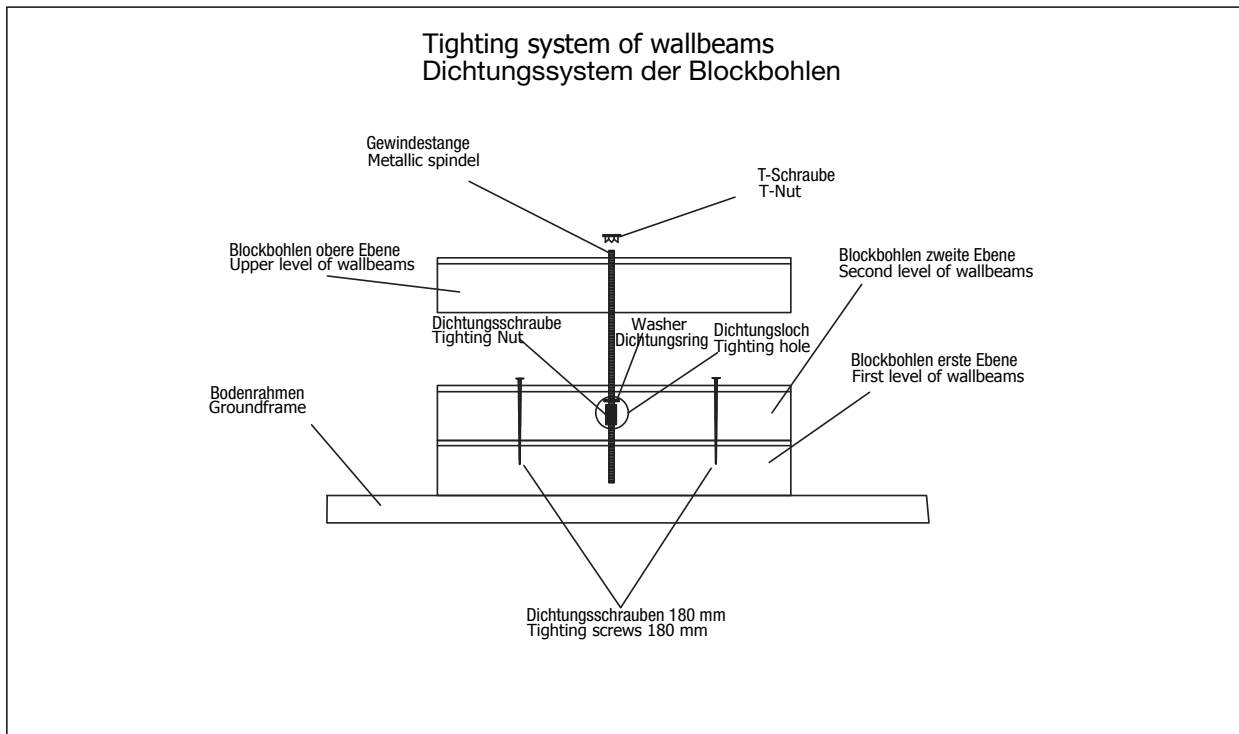
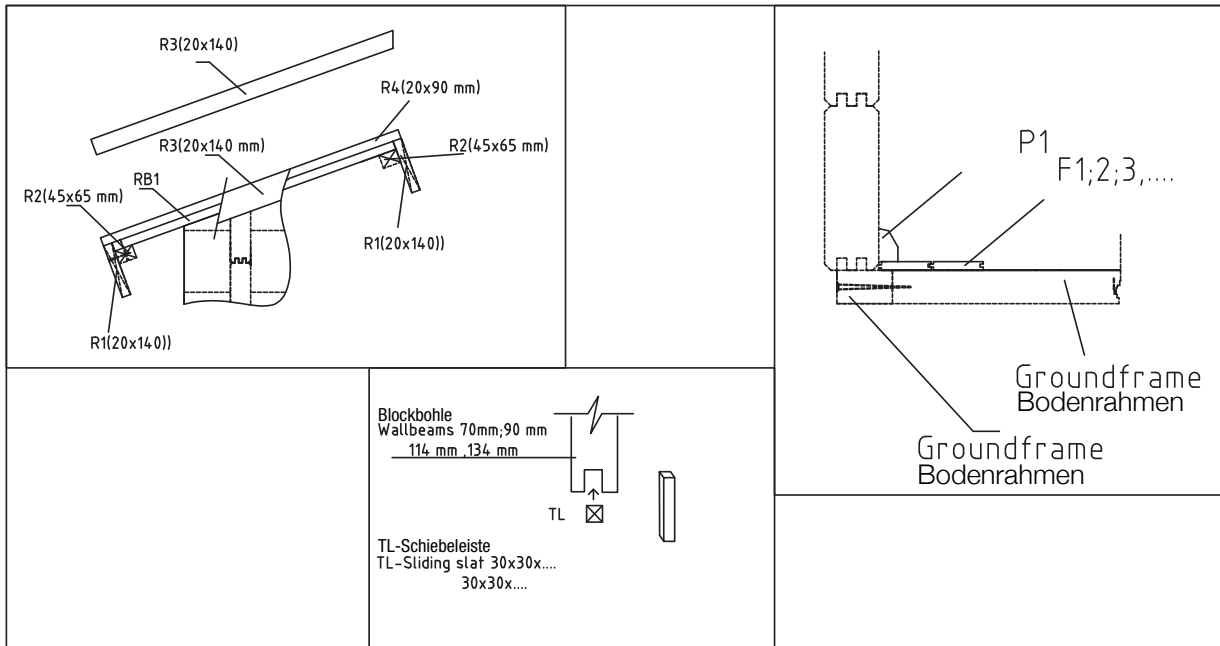

Wandplan 1 und 2 870600

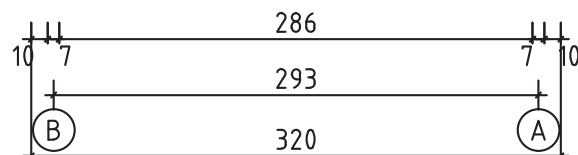
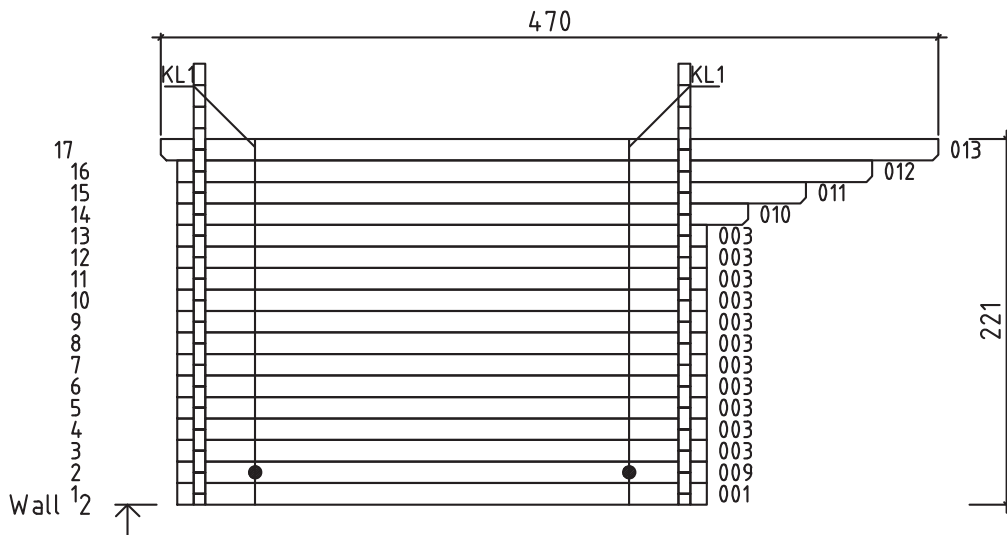
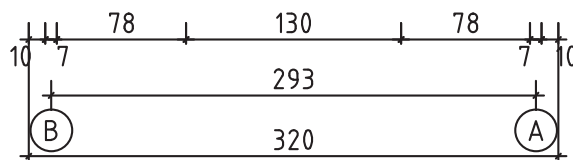
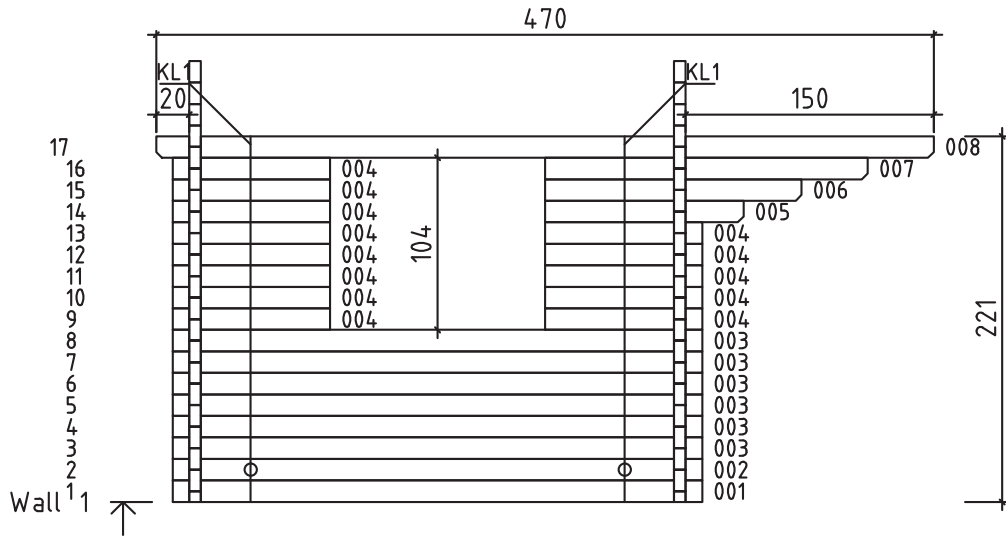

Wandplan A und B 870600

