

Technische Daten: Art.-Nr.: 870630

Wandaußenmaß: 450 x 360 cm

Bohlenstärke: 70 mm



Nordkap 70-D, durch Kunden farblich endbehandelt.

Kontrolliert durch:

Achtung: Alle angegebenen Maße sind ca.-Maße!

3D-Darstellung und Grundriss 870630

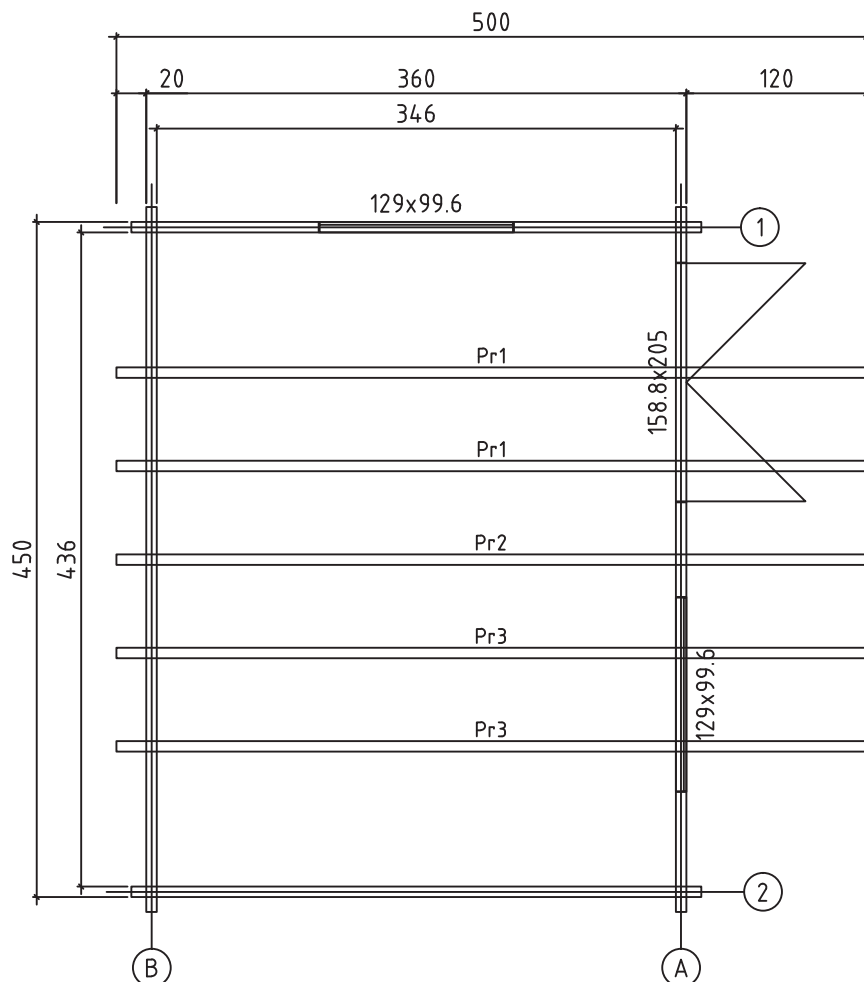
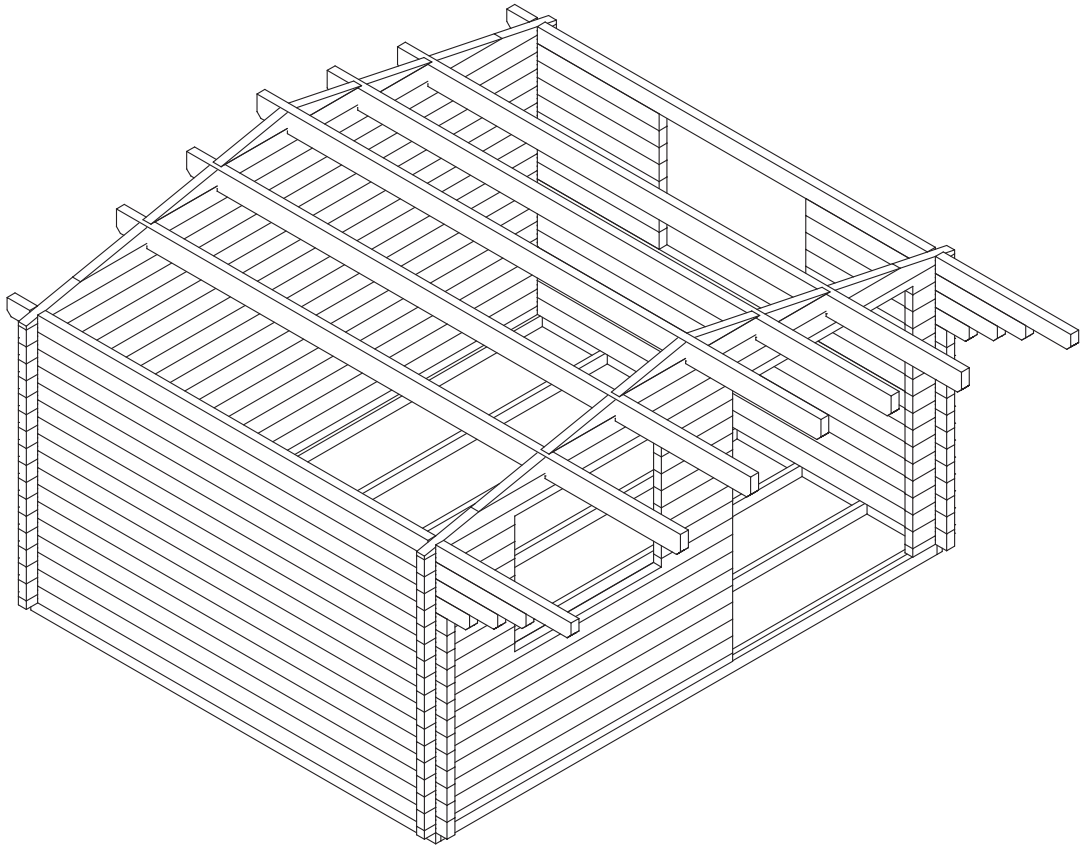











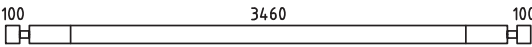
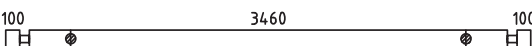
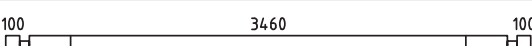
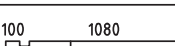
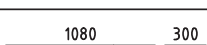
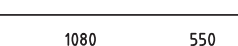
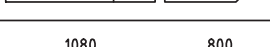

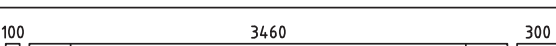
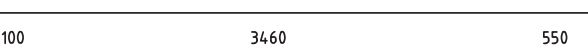
Lagerholzplan und Fundamentplan 870630

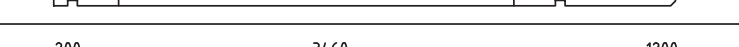
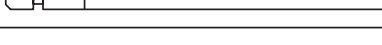
Wir empfehlen als Fundament für Ihr Gartenhaus eine vollflächig,
festgegründete gepflasterte oder betonierte Fläche.
Wahlweise ist auch ein Punkt- oder Streifenfundament möglich.



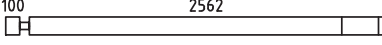
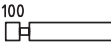

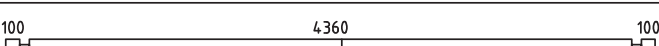

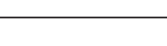





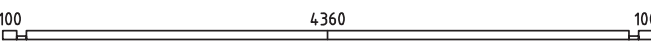
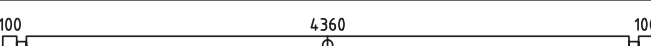
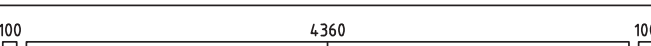
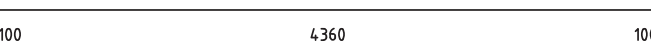
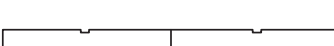

Teileliste 1

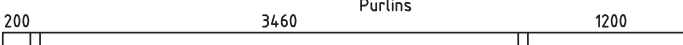
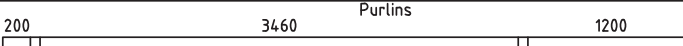
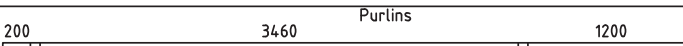
870630

Pos			Profil (mm)	Lenght (mm)
001		2	70x130	3800
002		2	70x130	3800
003		17	70x130	3800
004		13	70x130	1250
005		1	70x130	1450
006		1	70x130	1700
007		1	70x130	1950
008		1	70x130	5000
009		1	70x130	4000
010		1	70x130	4250
011		1	70x130	4500
012		1	70x130	5000
013		1	70x65	2732
014		1	70x65	370
015		1	70x130	2732
016		15	70x130	370
017		6	70x130	2732
018		1	70x130	2732
019		7	70x130	801
020		7	70x130	631
021		1	70x130	4700
022		1	70x130	4700
023		11	70x124	593
024		1	70x130	2431
025		1	70x130	1186

Teileliste 2

870630

Pos			Profil (mm)	Lenght (mm)
026			70x124	593
027			70x65	4700
028			70x130	4700
029			70x130	4700
030			70x130	4700
031			70x130	2431
032			70x130	1186
GR1	GROUNDFRAME 		45x90	4400
GR2	GROUNDFRAME 		45x90	3590
FB1	FLOORBEAMS 		45x90	4400
Pr1	Purlins 		70x170	5000
Pr2	Purlins 		70x170	5000
Pr3	Purlins 		70x170	5000
	WINDOW 1290x996			
	DOOR 1588x2050			
1	Screws/Schrauben/Vis 5x100 mm- For fixing first row of wall logs /Fixierung des ersten Bohlenkranzes/Pour fixer les lames de plancher			6
2	Nails/Nägel/Clous 2.1x50 - For fixing floorboards/ Befestigung Fussbodenbretter/Pour fixer les lames de plancher			350
3	Nails/Nägel/Clous 2.1x50 - For fixing roofboards/ Befestigung Dachbretter/Pour fixer les voliges			464
4	Nails/Nägel/Clous 2.1x50 - For fixing floor edge trims/ Befestigung Fussleisten/Pour fixer les plinthes du plancher			30
5	Nails/Nägel/Clous 2.1x50 - For fixing roofing felt fillet/ Befestigung giebelabschlussbrett/Pour fixer la latte de finition de la couverture			20
6	Screws/Schrauben/Vis 3,5x50 mm- For fixing roof side boards and roof edge reinforcement Befestigung Traufenbretter und Traufenleisten Pour fixer les planches de rive et le tasseau de refront			44
7	Screws/Schrauben/Vis 3,5x50 mm- For fixing fascia boards and diamonds/ Befestigung Giebelblende und Raute Pour fixer les planches de rive et le diamant			28
8	Screws/Schrauben/Vis 3,5x50 mm- For fixing fwindow and door trims/ Befestigung Fenster und türen/ Pour fixer les croisillons des fenestres et des portes			68

Teileliste 4

870630

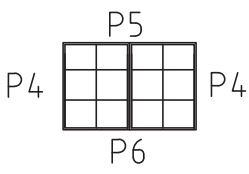
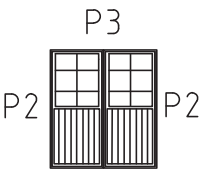
POS	ST.	B	H	L	Teileliste	
FB1	Vt. spetsi				FUNDMENTHOLZER	
F1	15,1m ²	20		3455	FUSSBODENBRETTER	50/39/32
PR	5	70	170	5000	DACHBALKEN	
RB1	25,54m ²	20		2554	DACHBRETTER	116/90/74
R1	2	20	120	5000	<i>Vaata katuse kaldenurka</i> Traufenbretter	
R2	2	45	65	5000	<i>Vaata katuse kaldenurka</i> Traufenbretter	
R3	4	20	120	2750	<i>Vaata katuse kaldenurka</i> Giebelabschlussleiste	
R4	4	20	90	2750	Giebelabschlussleiste	
WN13	2	1290	996			
DR16	1	1588	2050	 <div style="display: inline-block; vertical-align: middle; margin-left: 20px;"> Sliding slats 30x30x1900 mm - 2 pcs. 30x30x800 mm - 2 pcs. </div>		
P1	17m	20	40		Fussbodenleiste	
P2	2+2	20	90	2030	Türleiste DR16	
P3	1+1	20	90	1890	Türleiste DR16	
P4	4+4	20	90	1100	Fensterleiste WN13	
P5	2+2	20	90	1590	Fensterleiste WN13	
P6	2+2	20	90	1250	Fensterleiste WN13	

Detailzeichnungen 870630

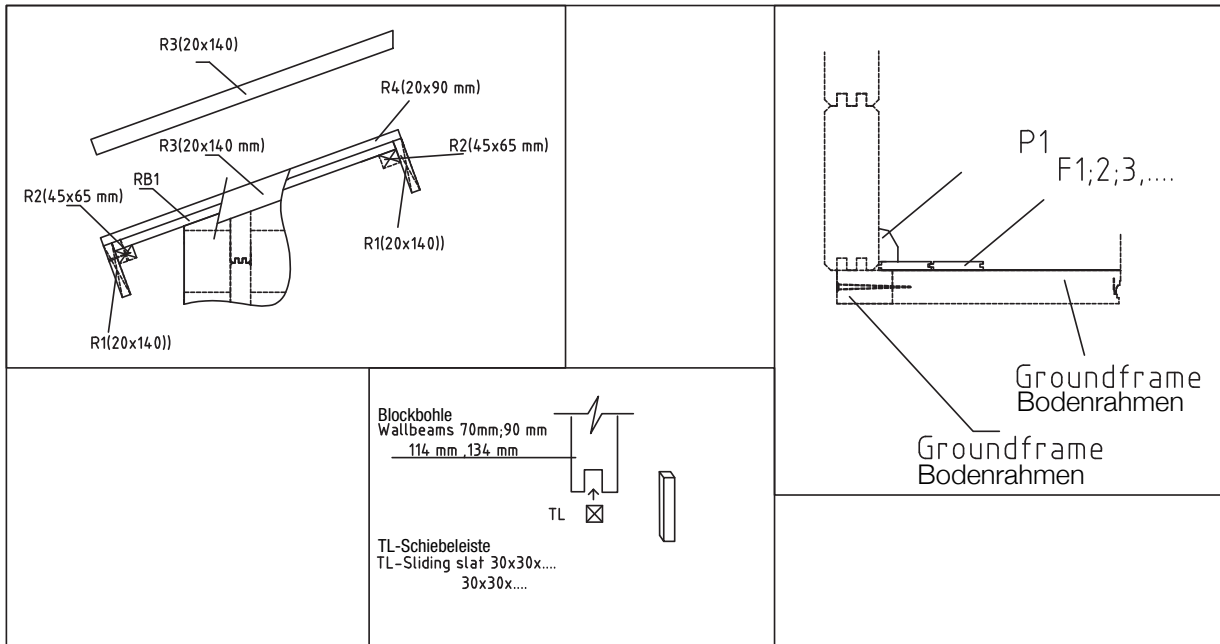

Tighting system of wallbeams Dichtungssystem der Blockbohlen

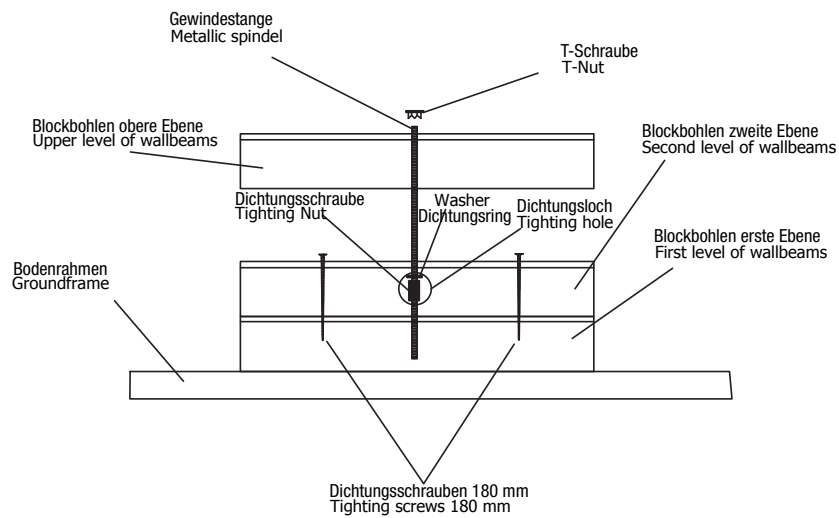

Wandplan 1 und 2 870630

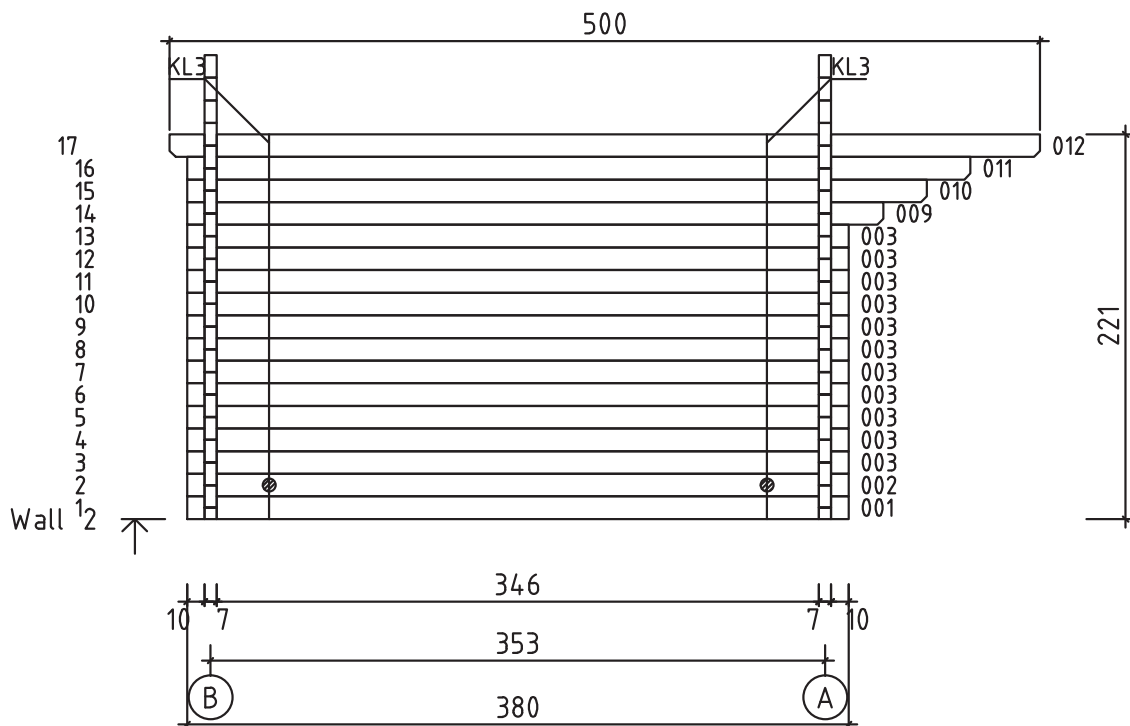
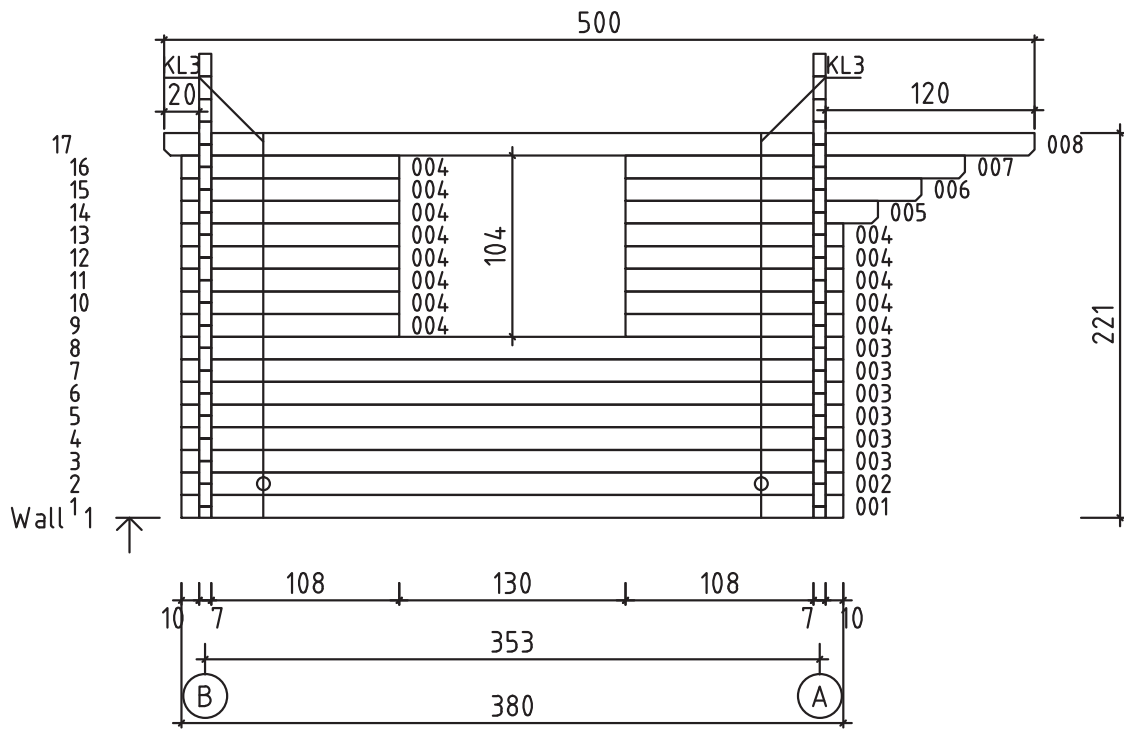

Wandplan A und B 870630

