

Technische Daten: Art.-Nr.: 870660

Wandaußenmaß: 400 x 500 cm

Bohlenstärke: 70 mm



Nordkap 70-L, durch Kunden farblich endbehandelt.

Kontrolliert durch:

Empty box for signature or name.

Achtung: Alle angegebenen Maße sind ca.-Maße!

3D-Darstellung und Grundriss 870660

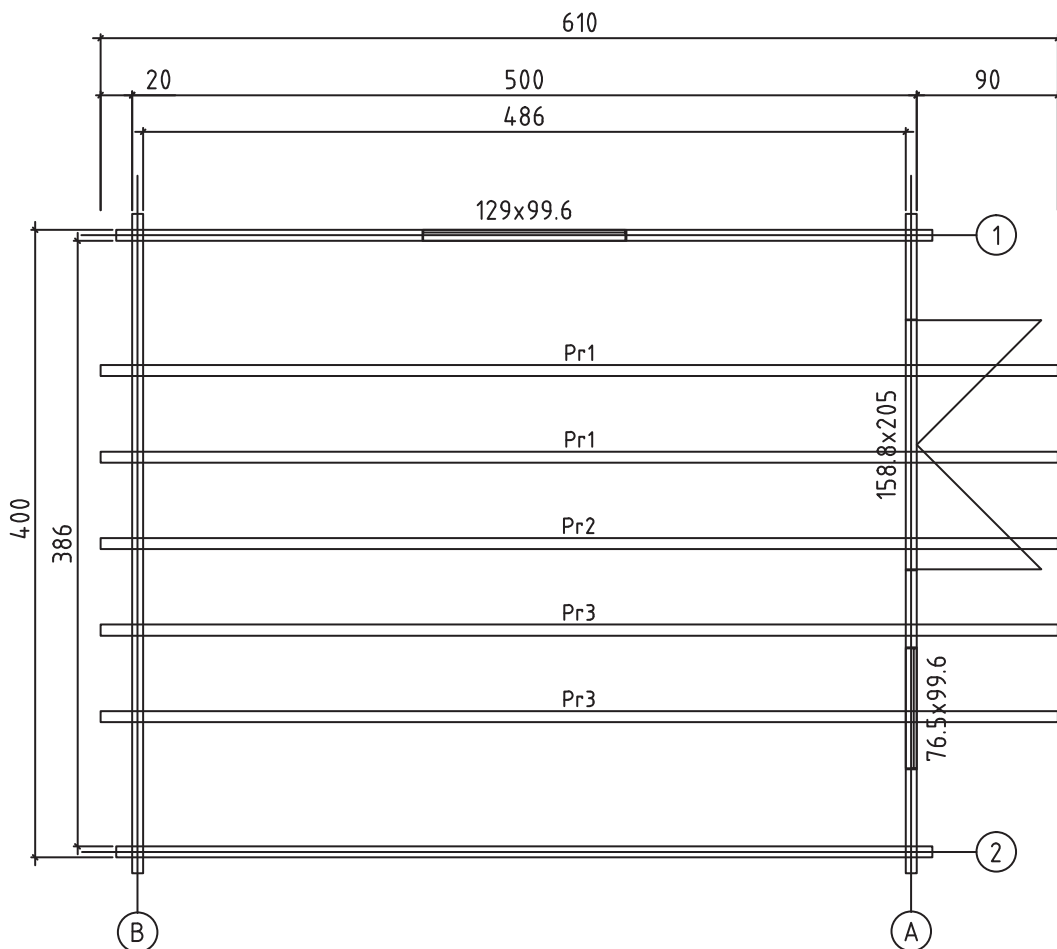
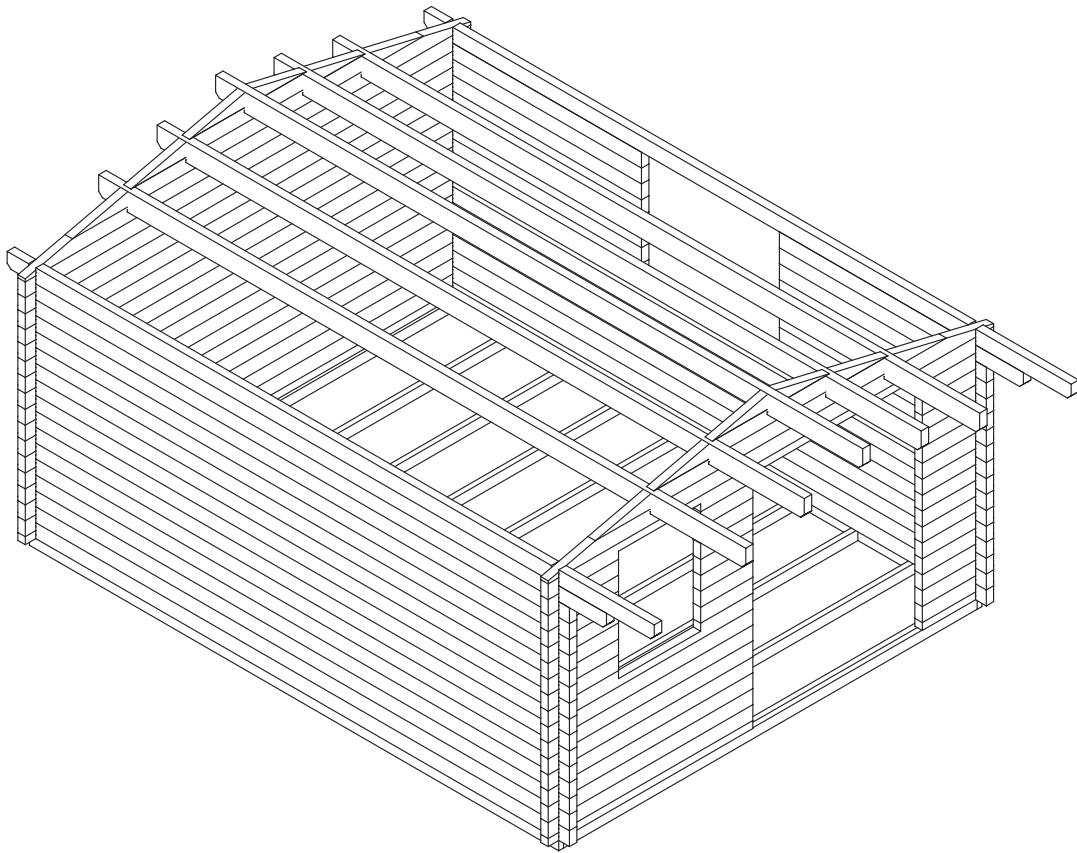

Lagerholzplan und Fundamentplan 870660

Wir empfehlen als Fundament für Ihr Gartenhaus eine vollflächig,
festgegründete gepflasterte oder betonierte Fläche.
Wahlweise ist auch ein Punkt- oder Streifenfundament möglich.

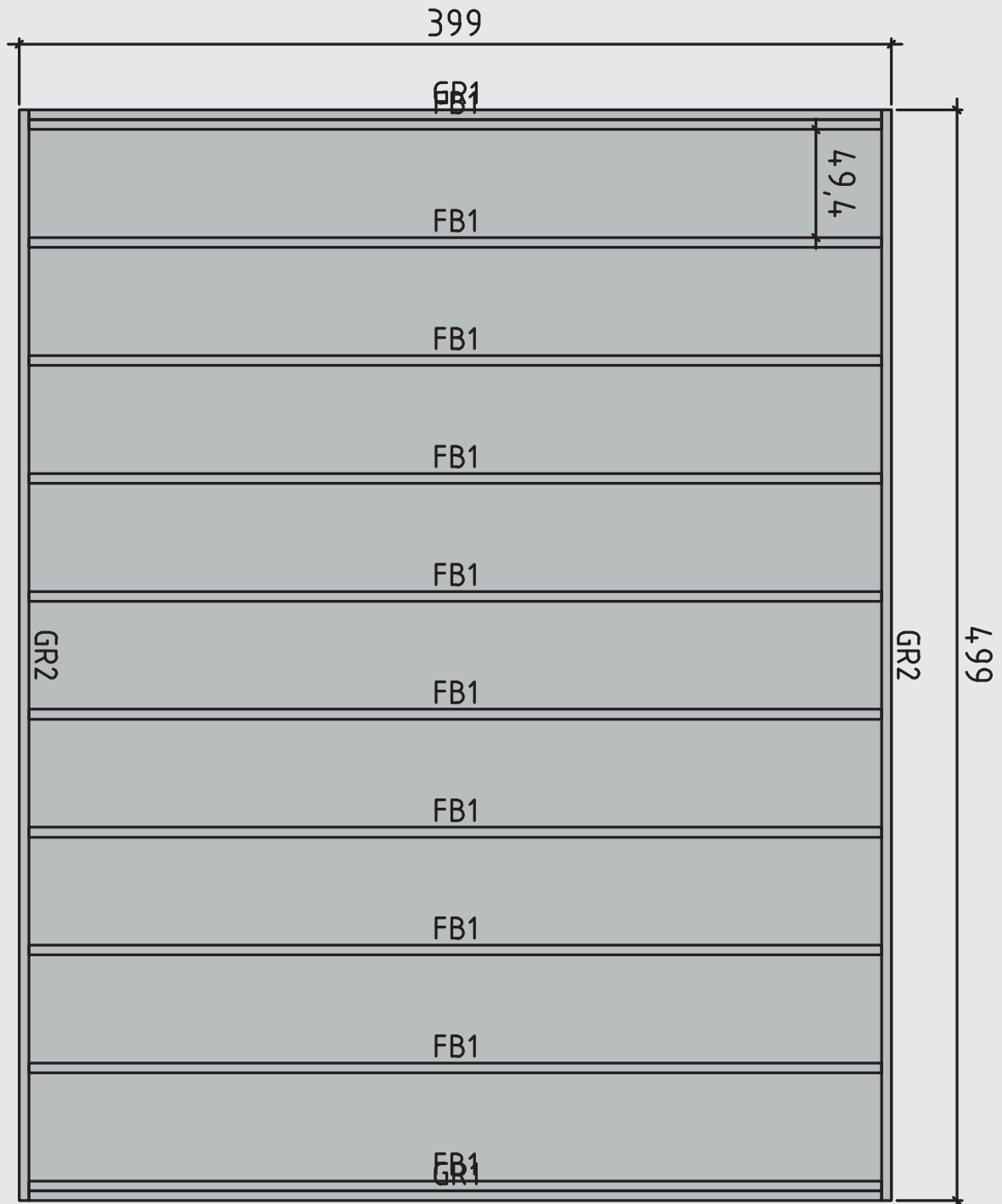











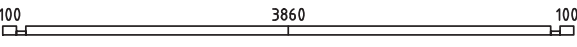
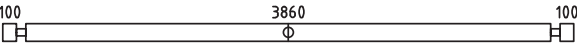
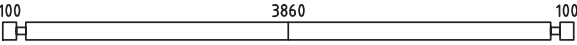
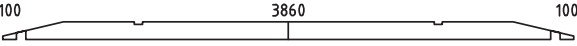

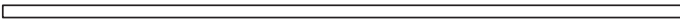
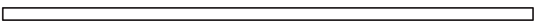
Teileliste 1

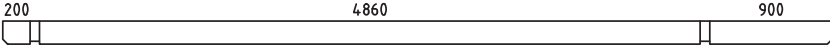
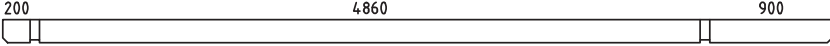
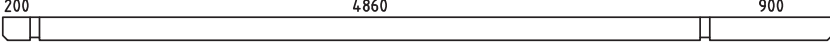
870660

Pos			Profil (mm)	Lenght (mm)
001		1	70x130	5200
002		1	70x130	5200
003		6	70x130	5200
004		15	70x130	1950
005		1	70x130	2300
006		1	70x130	6100
007		1	70x130	5200
008		1	70x130	5200
009		13	70x130	5200
010		1	70x130	5550
011		1	70x130	6100
012		1	70x65	1930
013		1	70x65	672
014		1	70x130	1930
015		15	70x130	672
016		6	70x130	1930
017		1	70x130	1930
018		7	70x130	663
019		7	70x130	493
020		1	70x130	4200
021		1	70x130	4200
022		11	70x123	521
023		1	70x130	214.6
024		1	70x130	104.3
025		1	70x123	521















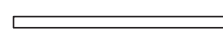



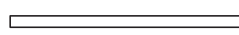

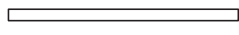
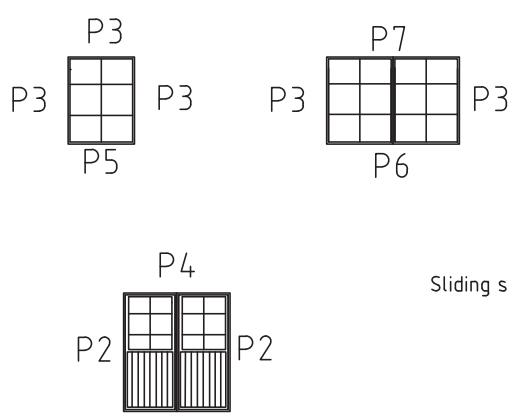

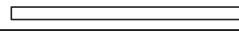
Teileliste 2

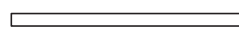
870660

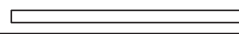
Pos			Profil (mm)	Lenght (mm)
026		1	70x65	4200
027		1	70x130	4200
028		15	70x130	4200
029		1	70x130	4200
030		1	70x130	2146
031		1	70x130	1043
GR2	GROUNDFRAME 	2	45x90	4990
GR1	GROUNDFRAME 	2	45x90	3900
FB1	FLOORBEAMS 	10	45x90	3900
Pr1	Purlins 200 4860 900 	2	70x170	6100
Pr2	Purlins 200 4860 900 	1	70x170	6100
Pr3	Purlins 200 4860 900 	2	70x170	6100
	WINDOW 1290x996	1		
	WINDOW 765x996	1		
	DOOR 1588x2050	1		
1	Screws/Schrauben/Vis 5x100 mm- For fixing first row of wall logs /Fixierung des ersten Bohlenkranzes/Pour fixer les lames de plancher		6	
2	Nails/Nägel/Clous 2.5x50 - For fixing floorboards/ Befestigung Fussbodenbretter/Pour fixer les lames de plancher		360	
3	Nails/Nägel/Clous 2.5x50 - For fixing roofboards/ Befestigung Dachbretter/Pour fixer les voliges		500	
4	Nails/Nägel/Clous 2.5x50 - For fixing floor edge trims/ Befestigung Fussleisten/Pour fixer les plinthes du plancher		30	
5	Nails/Nägel/Clous 2.5x50 - For fixing roofing felt fillet/ Befestigung giebelabschlussbrett/Pour fixer la latte de finition de la couverture		20	
6	Screws/Schrauben/Vis 2,5x50 mm- For fixing roof side boards and roof edge reinforcement Befestigung Traufenbretter und Traufenleisten Pour fixer les planches de rive et le tasseau de refront		44	
7	Screws/Schrauben/Vis 2,5x50 mm- For fixing fascia boards and diamonds/ Befestigung Giebelblende und Raufe Pour fixer les planches de rive et le diamant		28	
8	Screws/Schrauben/Vis 2,5x50 mm- For fixing fwindow and door trims/ Befestigung Fenster und türen/ Pour fixer les croisillons des fenetres et des portes		44	

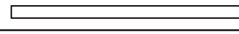
Teileliste 4

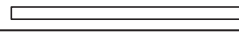
870660

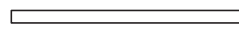
POS	ST.	B	H	L	ERKLÄRUNG
FB1	Vt. spetsi				 Fundamentholzer
F1	18,75 m	228		4855	 Fussbodenbretter 45/34/28
PR	5	70	170	6100	 Dachbalken
RB1	28,24 m ²	20		2315	 Dachbretter 125/95/73
R1	4	20	120	3050	<i>Vaata katuse kaldenurka</i>  Traufenbretttert 
R2	4	45	65	3050	<i>Vaata katuse kaldenurka</i>  Traufenbretter 
R3	4	20	120	2500	<i>Vaata katuse kaldenurka</i>  Giebelblende 
R4	4	20	90	2500	 Giebelblende 
WN07	1	765	996		 <p>Sliding slats 30x30x1900 mm - 2 pcs. 30x30x800 mm - 2 pcs.</p>
WN13	1	1290	996		
DR16	1	1588	2050		
P1	19m	20	40		 Fussbodenleiste
P2	2+2	20	90	2030	 Türleiste DR16 
P3	10	20	90	1100	 Fensterleiste WN13; WN07 
P4	1+1	20	90	1890	 Türleiste DR16 
P5	1+1	20	90	725	 Fensterleiste WN07 
P6	1+1	20	90	1250	 Fensterleiste WN13 
P7	1+1	20	90	1590	 Fensterleiste WN13 

Detailzeichnungen 870660

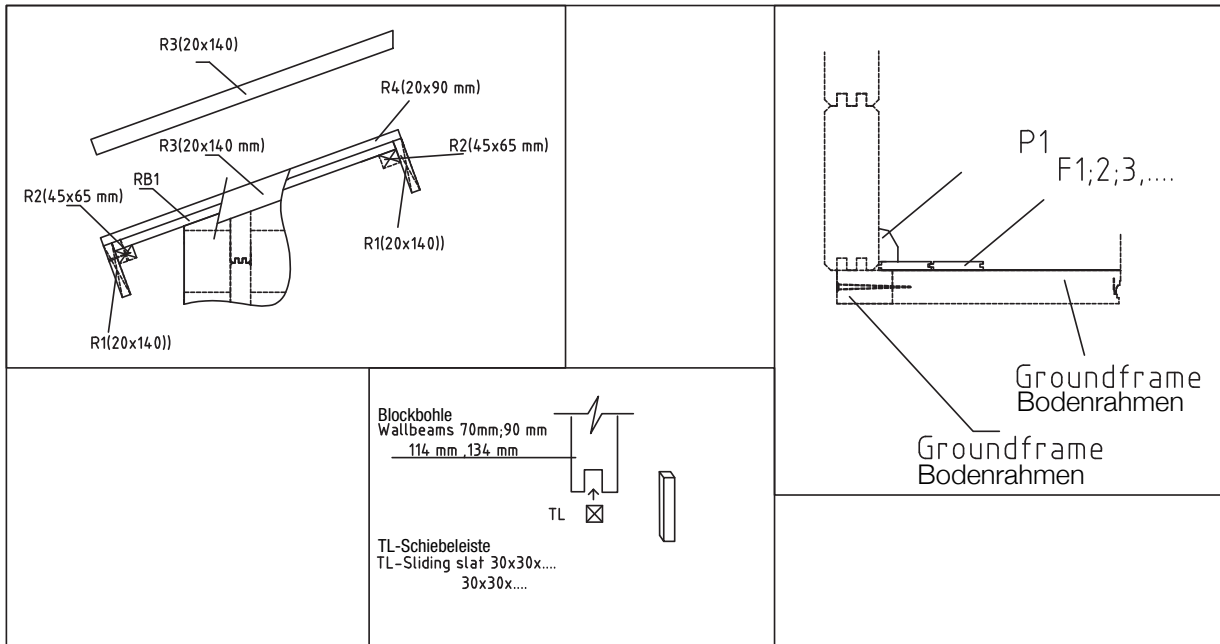

Tighting system of wallbeams Dichtungssystem der Blockbohlen

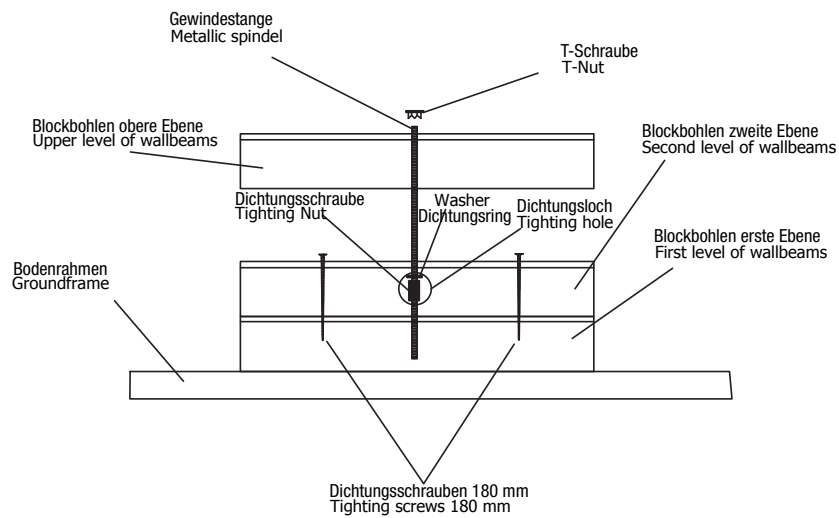

Wandplan 1 und 2 870660

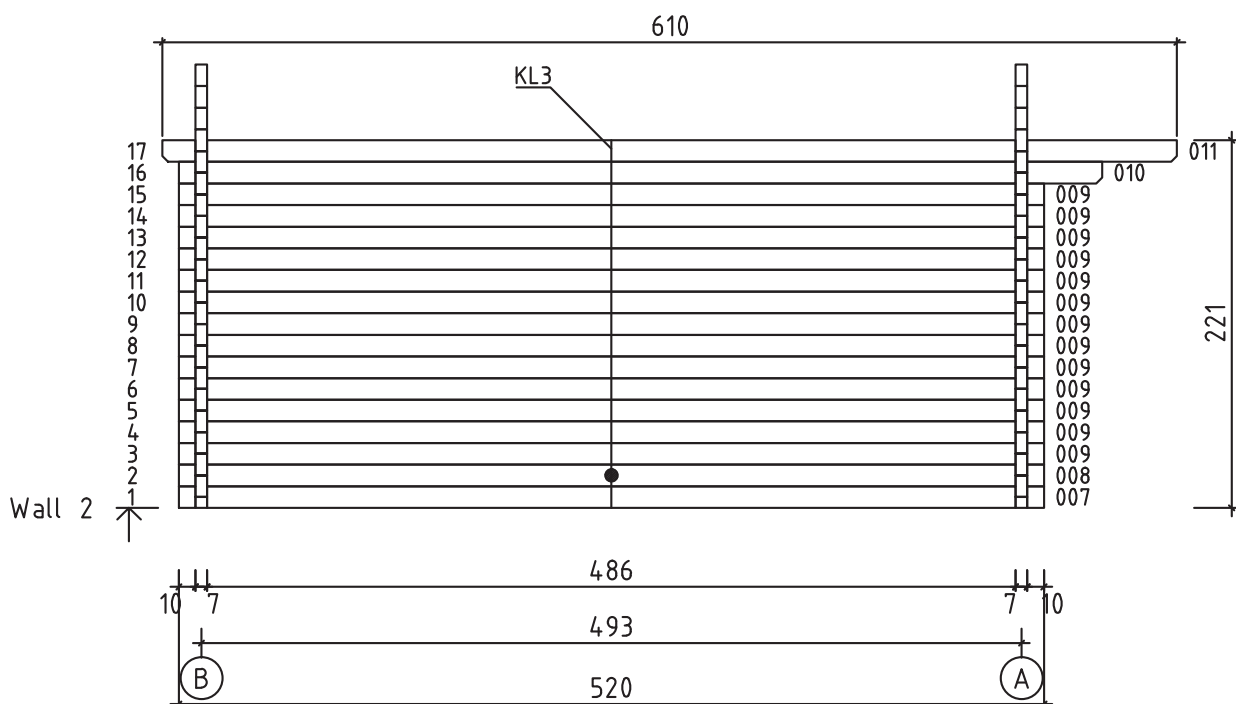
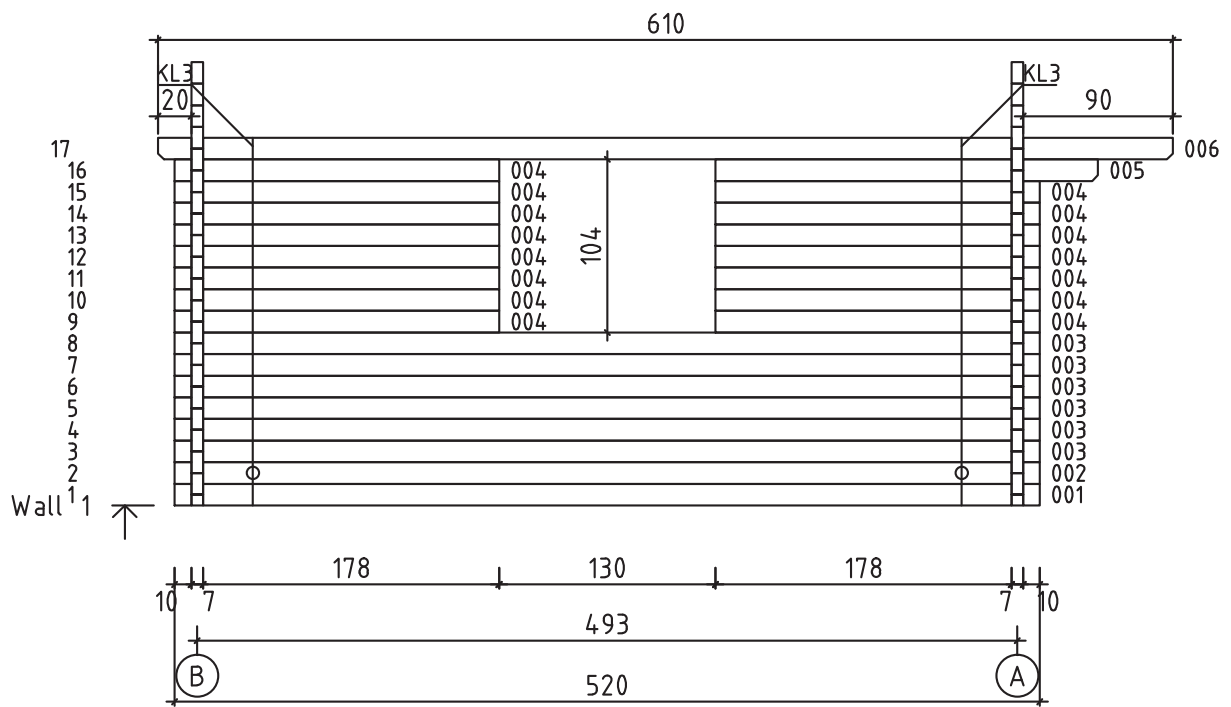

Wandplan A und B 870660

