

Technische Daten

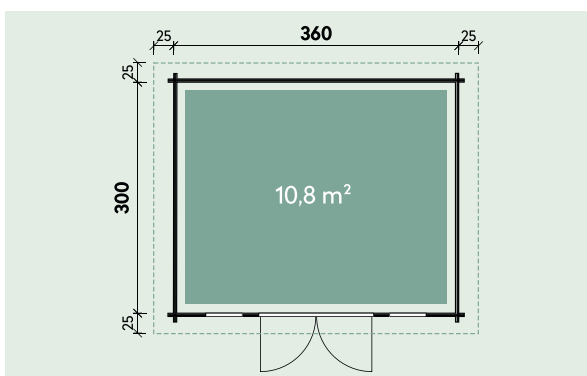

Artikelnummer:

871 600





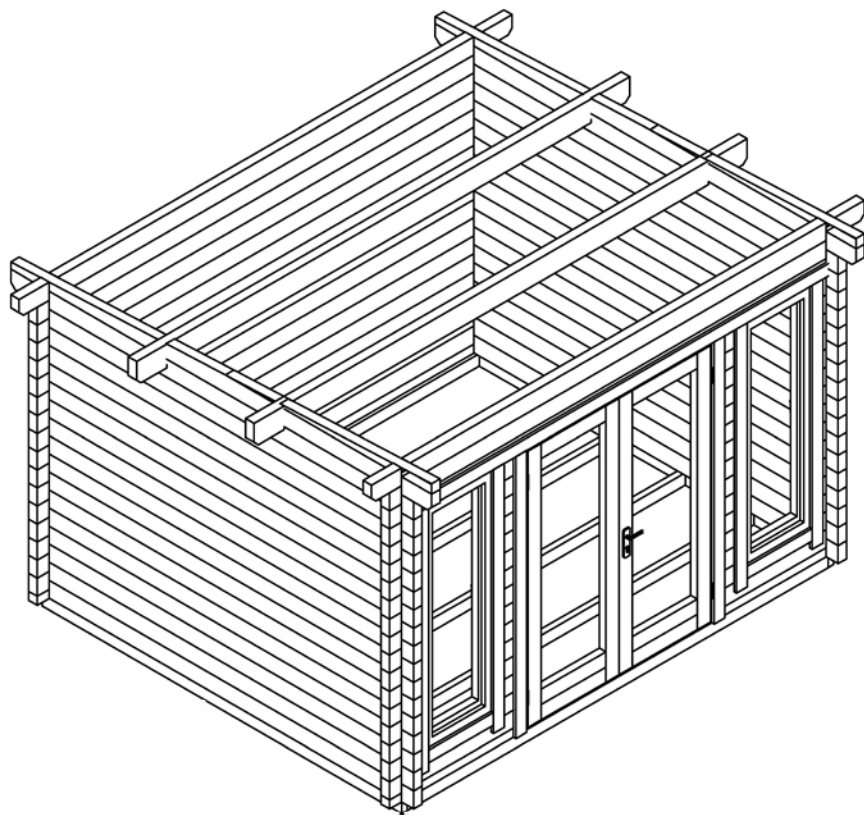

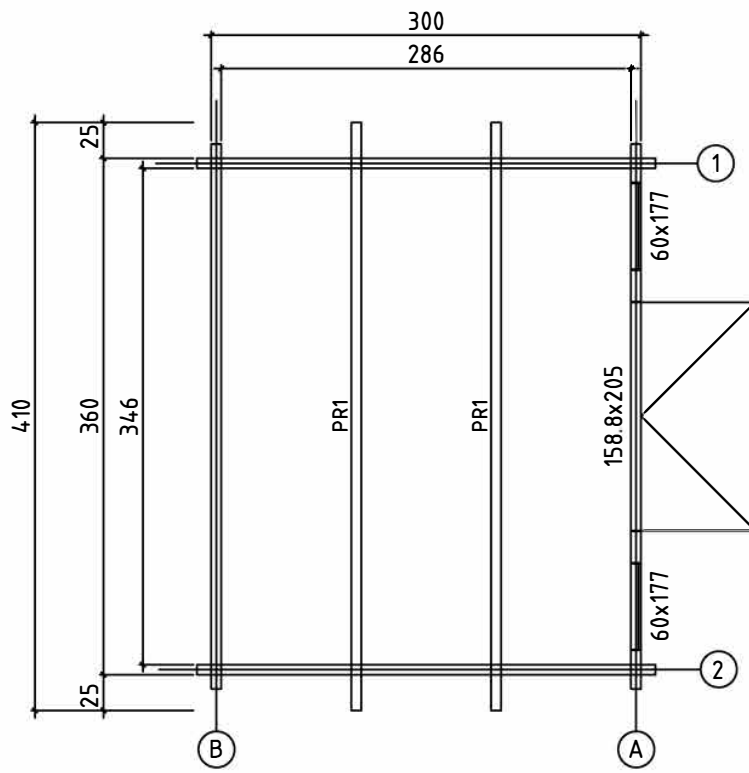

Kontrolliert durch:

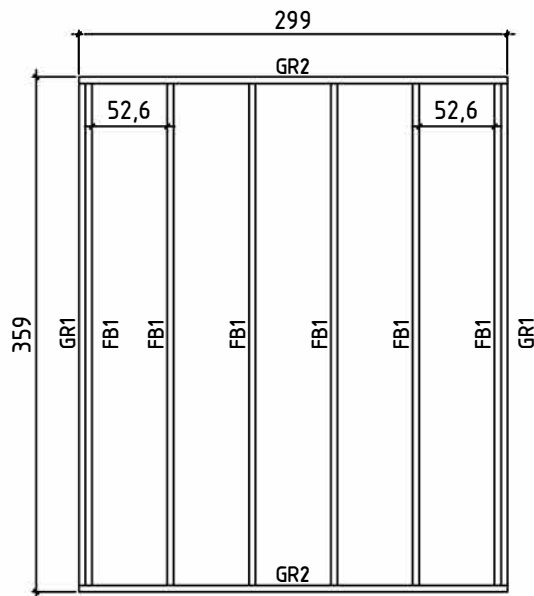

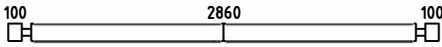
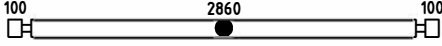
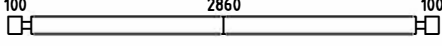
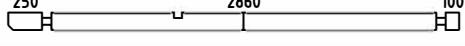
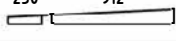
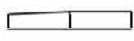
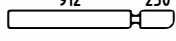
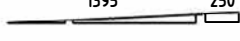
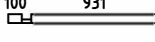
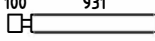
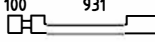

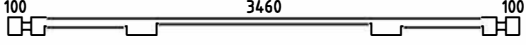
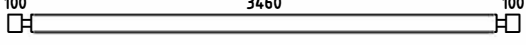
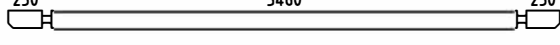
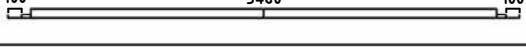
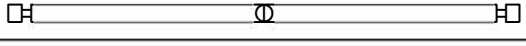
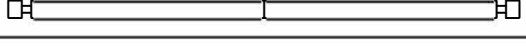
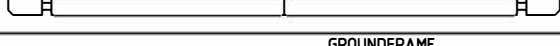

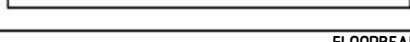



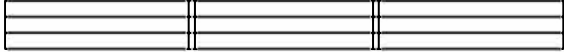
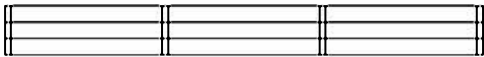

















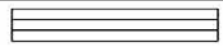



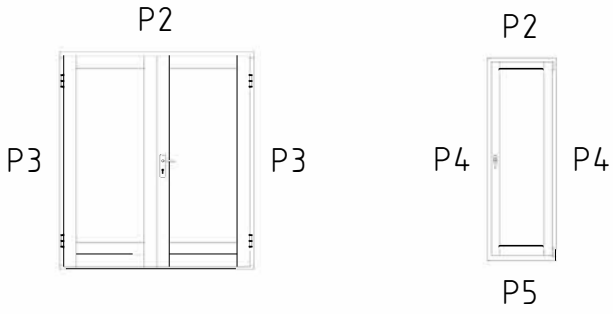

Wir empfehlen als Fundament für Ihr Gartenhaus eine vollflächig festgegründete, gepflasterte oder betonierte Fläche. Wahlweise ist auch ein Punkt- oder Streifenfundament möglich.



Pos		Quantity	Profil (mm)	Lenght (mm)
001		2	70x130	3200
002		2	70x130	3200
003		28	70x130	3200
004		2	70x130	3350
005		2	70x105	1232
006		2	70x130	917
007		2	70x130	1232
008		2	70x76	1715
009		2	70x65	1101
010		2	70x130	1101
011		2	70x130	1101
012		26	70x130	270
013		26	70x130	221
014		1	70x130	3800
015		1	70x130	3800
016		1	70x130	4100
017		1	70x65	3800
018		1	70x130	3800
019		15	70x130	3800
020		1	70x130	4100
GR1		2	45x90	3500
GR2		2	45x90	2990
FB1		6	45x90	3500
PR1		2	70x170	4100
	WINDOW 600x1770	2		

Pos		Quantity	Profil (mm)	Lenght (mm)
	D00R 1588x2050	1		
	<p>PARAPET R1 - 2 pcs.</p>  <p>PARAPET R2 - 2 pcs.</p> 			
1	Screws/Schrauben/Vis 5x100 mm- For fixing first row of wall logs /Fixierung des ersten Bohlenkranzes/Pour fixer les lamesde plancher		6	
2	Nails/Nägel/Clous 2.5x50 - For fixing floorboards/ Befestigung Fussbodenbretter/Pour fixer les lames de plancher		250	
3	Nails/Nägel/Clous 2.5x50 - For fixing roofboards/ Befestigung Dachbretter/Pour fixer les voliges		250	
4	Nails/Nägel/Clous 2.5x50 - For fixing floor edge trims/ Befestigung Fussleisten/Pour fixer les plinthes du plancher		30	
5	Screws/Schrauben/Vis 2,5x50 mm- For fixing parapet / Befestigung parapet / Pour fixer les parapet		145	
6	Screws/Schrauben/Vis 2,5x50 mm- For fixing window and door trims/ Befestigung Fenster und türen/ Pour fixer les croisillons des fenetres et des portes			
7	Metal storm Brace/Gewindestange/Tige filetee 8 mm		3	
8	<p>Shim;Nuts/Mutter ,U-Scheibe/Ecrou;Rondelle 8 mm For fixing storm braces/ Pour fixer les anti tempete/ Für Sturmleisten Pour fixer les croisillons des fenetres et des portes</p> <p>Metal storm Brace/Gewindestange/Tige filetee 8 mm KL1 M8 2,37 m 1 Screws 180 6 pcs. KL2 M8 2,44 m 2 Plastic caps 3 pcs.</p>		3/3	
9	Roofing felt/Dachpappe/Feutre de toiture		10+15	
10	Nails/Nägel/Clous - For fixing roofing felt/ Befestigung Dachpappe/Pour fixer les feutre de toiture		160	

POS	ST.	B	H	L	Teileliste	
FB1	Vt. spetsi					FUNDMENTHOLZER 
F1	9,9m ²	28		2855		FUSSBODENBRETTER
PR	2	70	170	4100		DACHBALKEN 
RB1	14,4m ²	20		3503		DACHBRETTER
R1	2	20	360	4140		PARAPET
R2	2	20	360	3545		PARAPET
R3	2	45	45	4100		BEFESTIGUNG DACHBRETTER 
R4	2 2	45	90	250 295		BEFESTIGUNG PARAPET 
DR1 WN1	1 2	1588 600	2050 1770	 <p style="text-align: center;">P2</p> <p style="text-align: center;">P3</p> <p style="text-align: center;">P4</p> <p style="text-align: center;">P5</p> <p style="text-align: center;">Sliding slats 30x30x1600 mm - 4 pcs.</p>		
P1	14m	20	40			Fussbodenleiste
P2	1+1	20	90	3440		Türleiste DR1,WN1 
P3	2+2	20	90	2030		Türleiste DR1 
P4	4+4	20	90	1920		Fensterleiste WN1 
P5	2+2	20	90	540 570		Fensterleiste WN1 